

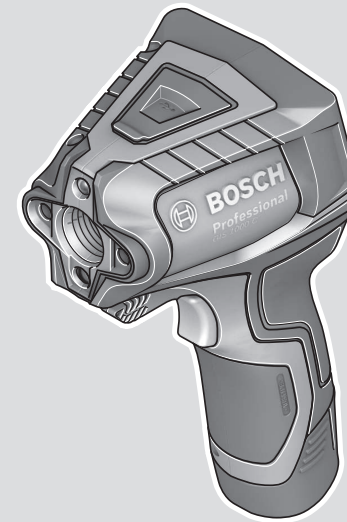

# GIS 1000 C Professional



Robert Bosch Power Tools GmbH  
70538 Stuttgart  
GERMANY

[www.bosch-pt.com](http://www.bosch-pt.com)

1 609 92A 62P (2020.12) T / 92



1 609 92A 62P

- en Original instructions
- zh 正本使用说明书
- zh 原始使用說明書
- ko 사용 설명서 원본
- th หนังสือคู่มือการใช้งานฉบับต้นแบบ
- id Petunjuk-Petunjuk untuk Penggunaan Orisinal
- vi Bản gốc hướng dẫn sử dụng



English .....	Page	6
中文 .....	页	18
繁體中文 .....	頁	28
한국어 .....	페이지	38
ไทย .....	หน้า	50
Bahasa Indonesia .....	Halaman	64
Tiếng Việt .....	Trang	77
<b>CE</b> .....		I

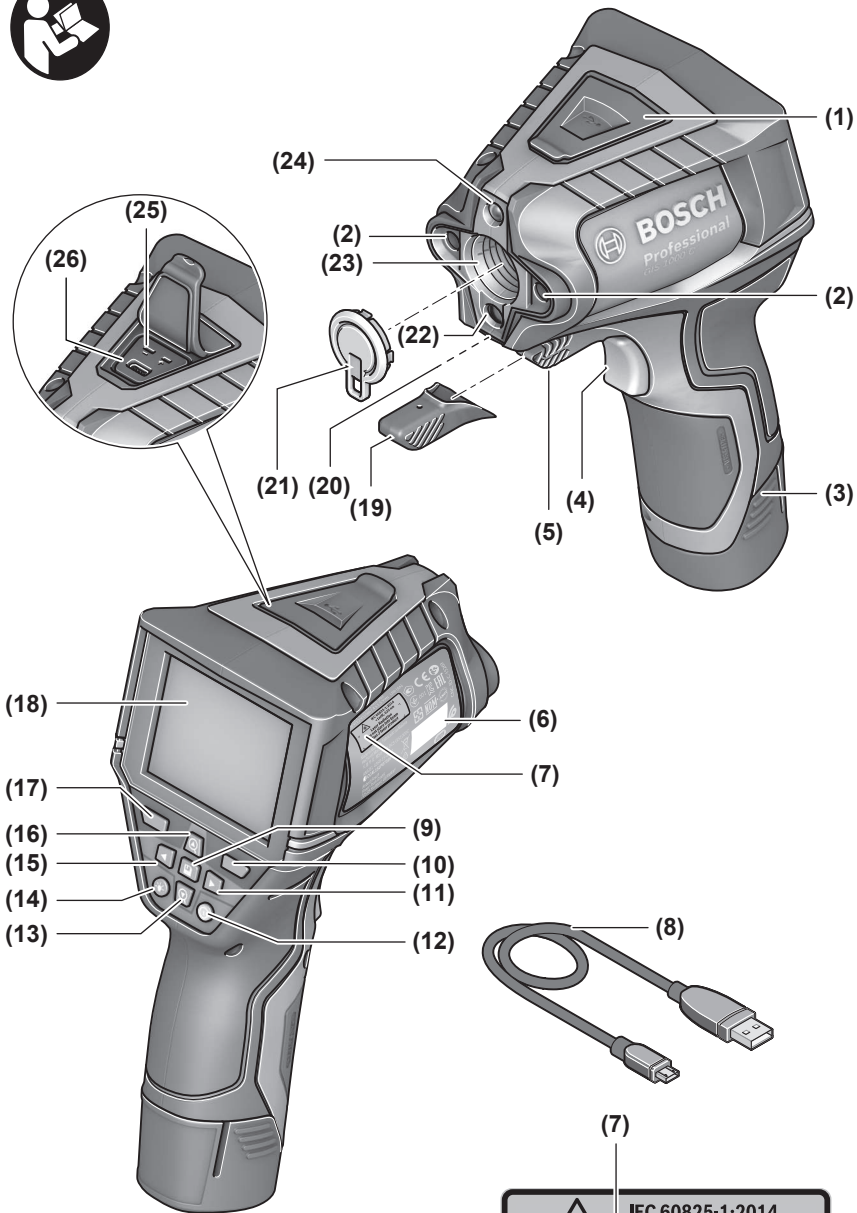

**(7)**

 IEC 60825-1:2014  
 <1mW, 635 nm  
**Laser Radiation**  
 Do not stare into beam  
 Class 2 laser product

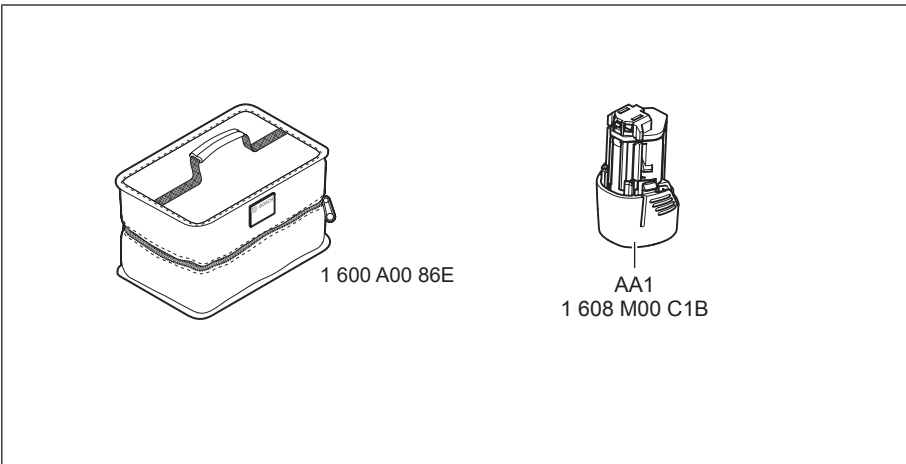
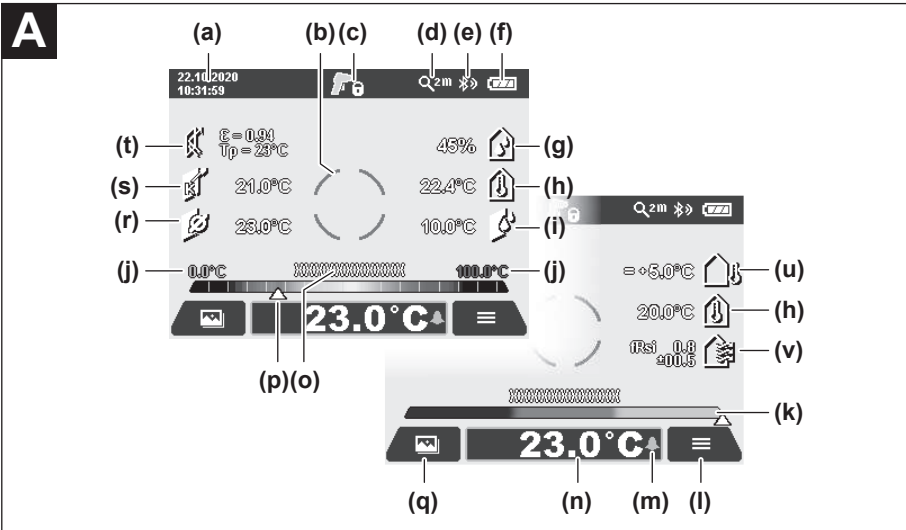

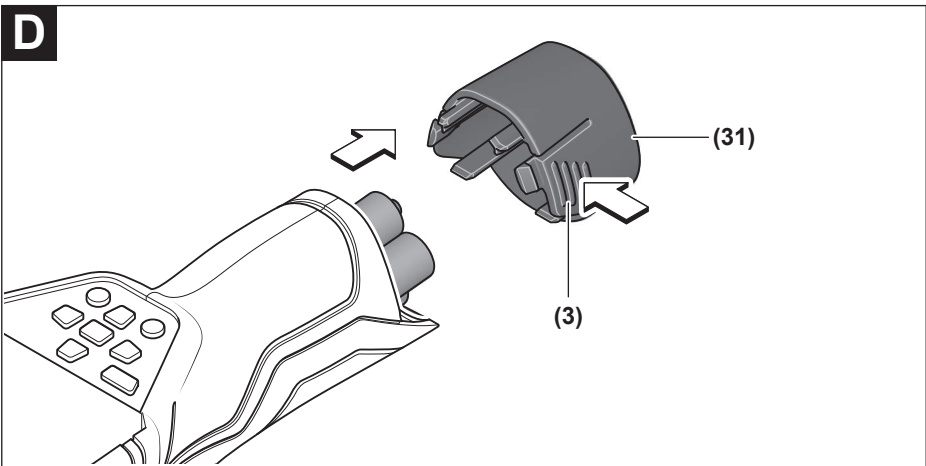
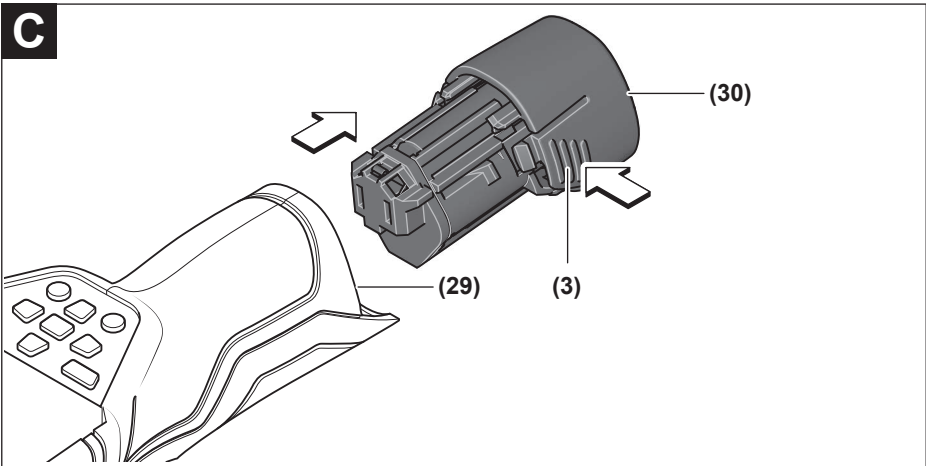
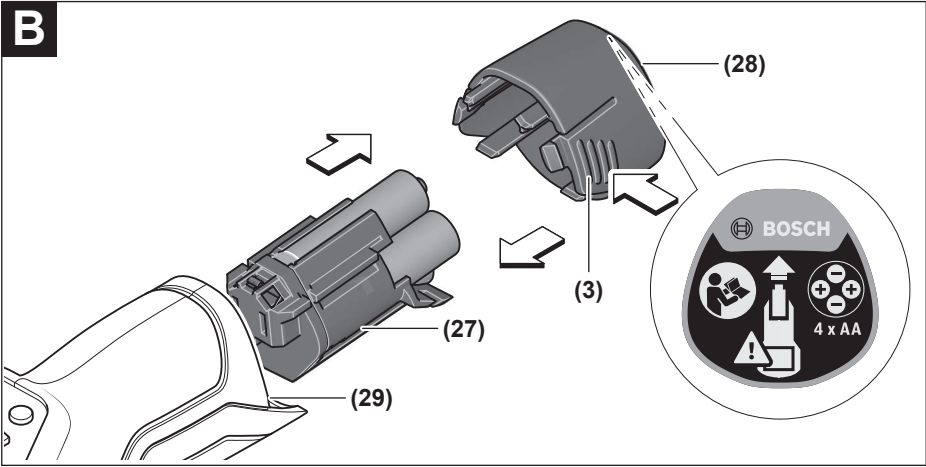

# English

## Safety Instructions



All instructions must be read and observed in order for the measuring tool to function safely. The safeguards integrated into the measuring tool may be compromised if the measuring tool is not used in accordance with these instructions. Never make warning signs on the measuring tool unrecognisable. **SAVE THESE INSTRUCTIONS FOR FUTURE REFERENCE AND INCLUDE THEM WITH THE MEASURING TOOL WHEN TRANSFERRING IT TO A THIRD PARTY.**

- ▶ **Warning! If operating or adjustment devices other than those specified here are used or other procedures are carried out, this can lead to dangerous exposure to radiation.**
- ▶ **The measuring tool is delivered with a laser warning sign (marked in the illustration of the measuring tool on the graphics page).**
- ▶ **If the text of the laser warning label is not in your national language, stick the provided warning label in your national language over it before operating for the first time.**



**Do not direct the laser beam at persons or animals and do not stare into the direct or reflected laser beam yourself.** You could blind somebody, cause accidents or damage your eyes.

- ▶ **If laser radiation hits your eye, you must close your eyes and immediately turn your head away from the beam.**
- ▶ **Do not make any modifications to the laser equipment.**
- ▶ **Do not use the laser goggles (accessory) as protective goggles.** The laser goggles make the laser beam easier to see; they do not protect you against laser radiation.
- ▶ **Do not use the laser goggles (accessory) as sunglasses or while driving.** The laser goggles do not provide full UV protection and impair your ability to see colours.
- ▶ **Have the measuring tool serviced only by a qualified specialist using only original replacement parts.** This will ensure that the safety of the measuring tool is maintained.
- ▶ **Do not let children use the laser measuring tool unsupervised.** They could unintentionally blind themselves or other persons.
- ▶ **Do not use the measuring tool in explosive atmospheres which contain flammable liquids, gases or dust.** Sparks may be produced inside the measuring tool, which can ignite dust or fumes.
- ▶ **Do not open the battery.** There is a risk of short-circuiting.

- ▶ **In case of damage and improper use of the battery, vapours may be emitted. The battery can set alight or explode.** Ensure the area is well ventilated and seek medical attention should you experience any adverse effects. The vapours may irritate the respiratory system.
- ▶ **If used incorrectly or if the battery is damaged, flammable liquid may be ejected from the battery. Contact with this liquid should be avoided. If contact accidentally occurs, rinse off with water. If the liquid comes into contact with your eyes, seek additional medical attention.** Liquid ejected from the battery may cause irritation or burns.
- ▶ **The battery can be damaged by pointed objects such as nails or screwdrivers or by force applied externally.** An internal short circuit may occur, causing the battery to burn, smoke, explode or overheat.
- ▶ **When the battery is not in use, keep it away from paper clips, coins, keys, nails, screws or other small metal objects that could make a connection from one terminal to another.** A short circuit between the battery terminals may cause burns or a fire.
- ▶ **Only use the battery with products from the manufacturer.** This is the only way in which you can protect the battery against dangerous overload.
- ▶ **Only charge the batteries using chargers recommended by the manufacturer.** A charger that is suitable for one type of battery may pose a fire risk when used with a different battery.



**Protect the battery against heat, e.g. against continuous intense sunlight, fire, dirt, water and moisture.** There is a risk of explosion and short-circuiting.



- ▶ **Remove the rechargeable battery/non-rechargeable batteries from the measuring tool before carrying out work on the measuring tool (e.g. assembly, maintenance, etc.). The battery/batteries should also be removed for transport and storage.** There is risk of injury from unintentionally pressing the on/off switch.
- ▶ **Caution! When using the measuring tool with Bluetooth®, a fault may occur in other devices and systems, aeroplanes and medical devices (e.g. pacemakers, hearing aids). Also, damage to people and animals in the immediate vicinity cannot be completely excluded. Do not use the measuring tool with Bluetooth® in the vicinity of medical devices, petrol stations, chemical plants, areas with a potentially explosive atmosphere and in blasting areas. Do not use the measuring tool with Bluetooth® on aeroplanes. Avoid using the product near your body for extended periods.**

**The Bluetooth® word mark and logos are registered trademarks owned by Bluetooth SIG, Inc. and any use of such marks by Robert Bosch Power Tools GmbH is under license.**

- ▶ **Protect the measuring tool, particularly the area around the air humidity, ambient temperature and in-**

**frared sensor, from moisture, snow, dust and dirt. The reception lens could fog up or become contaminated and distort the measurements.** Incorrect settings on the tool and other atmospheric influences may make the measurements inaccurate. Object temperatures could be shown to be hotter or colder than they are, which may present a danger if touched.

- ▶ **Correct temperature measurements are only possible if the set emissivity and emissivity of the object agree, and the correct reflected temperature is set.** Otherwise, object temperatures could be shown to be hotter or colder than they are, which may present a danger if touched.

### Safety Instructions When Using Thermocouples

- ▶ **Thermocouples must not be used in live electrical systems. This poses a risk to life!**
- ▶ **Using a thermocouple means contact with the object measured.** Therefore, watch out for potential dangers due to temperature, voltage or a chemical reaction.

## Product Description and Specifications

Please observe the illustrations at the beginning of this operating manual.

### Intended Use

The measuring tool is intended for contactless measurement of surface temperature, ambient temperature and relative humidity. It calculates the dew point temperature and indicates thermal bridges and mould risk. Mould spores cannot be detected with the measuring tool. However, it can help to detect conditions early on that can encourage mould growth.

The measuring tool may not be used to measure the body temperature of humans or animals or for other medical purposes.

The measuring tool is not suitable for measuring the surface temperature of gases.

Temperature measurement in liquids is only possible using a commercially available thermocouple (connection type K), which can be connected to the measuring tool via the interface (25) intended for this.

Surface temperature can also be measured by touching a surface with a thermocouple.

The light of this measuring tool is intended to illuminate the direct work area of the measuring tool in order to take pictures.

The laser points must not be used as a laser pointer. They are solely for marking out the area being measured.

The measuring tool is suitable for indoor and outdoor use.

### Product Features

The numbering of the product features shown refers to the illustration of the measuring tool on the graphic page.

- (1) Micro USB port flap/thermocouple (type K) connection
- (2) Laser beam outlet aperture
- (3) Battery pack/battery adapter/battery compartment cover release button
- (4) Measure button/on button
- (5) Humidity and ambient temperature sensor
- (6) Serial number
- (7) Laser warning label
- (8) Micro USB cable
- (9) Save/send button (*Bluetooth®*)
- (10) Right-hand function button
- (11) Right-hand arrow button
- (12) On/off button
- (13) Down arrow button/zoom out
- (14) Light on/off button
- (15) Left-hand arrow button
- (16) Up arrow button/zoom in
- (17) Left-hand function button
- (18) Display
- (19) Protective cap for humidity and ambient temperature sensor
- (20) Carrying strap lug
- (21) Protective cap for infrared reception lens
- (22) Camera
- (23) Infrared beam reception lens
- (24) Light
- (25) Type K connection for thermocouple
- (26) Micro USB port
- (27) Battery adapter cover<sup>a)</sup>
- (28) Battery adapter cap<sup>a)</sup>
- (29) Battery bay
- (30) Battery<sup>a)</sup>
- (31) Battery compartment cover<sup>a)</sup>

a) **Accessories shown or described are not included with the product as standard. You can find the complete selection of accessories in our accessories range.**

### Display elements (see figure A)

- (a) Date/time (see "<Time & Date>", page 15)
- (b) Measuring frame (see "Measured area for surface temperature measurements", page 11)
- (c) Status indicator:



Measuring tool is ready to measure; press the measure button (4).



(Continuous) measurement in progress; lasers are switched on.



Measurement complete, lasers are switched off, measurement results are fixed.



Contact temperature mode, lasers are deactivated, measurement taken only via thermocouple.

- (d) Zoom level display (see "Setting the zoom level", page 12)
- (e) *Bluetooth*® display switched on (see "Data transfer via Bluetooth®", page 14)
- (f) Battery charge indicator
- (g) Function indicator/measured value for relative humidity
- (h) Function indicator/measured value for ambient temperature
- (i) Function indicator/result for dew point temperature
- (j) Minimum/maximum measured value for surface temperature during a measurement
- (k) Result scale
- (l) Menu symbol
- (m) Surface temperature alarm display (see "Surface temperature alarm", page 13)
- (n) Measured value
- (o) Current mode
- (p) Mark for measured value or result (depending on selected mode)
- (q) Gallery symbol
- (r) Function indicator/measured value for average temperature
- (s) Function indicator/measured value for contact temperature
- (t) Emissivity/reflected temperature indicator
- (u) Set external temperature (thermal bridge mode)
- (v) Display of  $f_{\text{RSI}}$  value with tolerance (thermal bridge mode)

## Technical Data

Thermo detector	GIS 1000 C	GIS 1000 C
Article number	<b>3 601 K83 3..</b>	<b>3 601 K83 371</b>
Working range	0.1–5 m	0.1–5 m
Measuring range		
– Surface temperature	–40 to +1000 °C	–40 to +1000 °C
– Contact temperature	–40 to +1000 °C	–40 to +1000 °C
– Ambient temperature	–10 to +50 °C	–10 to +50 °C
– Relative humidity	0 to 100 %	0 to 100 %
<b>Measuring accuracy<sup>A)</sup></b>		
<b>Surface temperature<sup>B)</sup></b>		
–40 to –20.1 °C	±2.5 °C	±2.5 °C
–20 to –0.1 °C	±1.5 °C	±1.5 °C
<b>0 to +100 °C</b>	<b>±1 °C</b>	<b>±1 °C</b>
+100 °C to +400 °C	±1 %	±1 %
> +400 °C	±2 %	±2 %
<b>Ambient temperature</b>	±1 °C	±1 °C
<b>Relative humidity<sup>C)</sup></b>		
< 20 %	±3 %	±3 %
<b>20 to 60 %</b>	<b>±2 %</b>	<b>±2 %</b>
60 to 90 %	±3 %	±3 %
Optics (measuring distance:measured surface ratio) <sup>D)E)</sup>	50 : 1	50 : 1
Laser class	2	2
Laser type	635 nm, < 1 mW	635 nm, < 1 mW
Divergence (full angle)	< 1.5 mrad	< 1.5 mrad
Max. altitude	2000 m	2000 m
Pollution degree according to IEC 61010-1	2 <sup>F)</sup>	2 <sup>F)</sup>
Relative humidity max.	90 %	90 %



Thermo detector	GIS 1000 C	GIS 1000 C
Non-rechargeable batteries (alkaline manganese)	4 × 1.5 V LR6 (AA) (with battery adapter)	4 × 1.5 V LR6 (AA)
Rechargeable battery (Li-ion)	10.8 V/12 V	–
Operating time		
– Non-rechargeable batteries (alkaline manganese)	3 h	3 h
– Rechargeable battery (Li-ion) <sup>G)</sup>	10 h	–
Number of images in internal image memory	> 200	> 200
Bluetooth® (Classic and Low Energy)	4.2 <sup>H)</sup>	4.2 <sup>H)</sup>
Operating frequency range	2402–2480 MHz	2402–2480 MHz
Max. transmission power	2.5 mW	2.5 mW
USB port	2.0	2.0
Weight according to EPTA-Procedure 01:2014 <sup>G)</sup>	0.56–0.77 kg	0.51 kg
Dimensions (length × width × height)	136 × 89 × 214 mm	136 × 89 × 214 mm
Environmental conditions		
– Recommended ambient temperature during charging	0 °C to +35 °C	–
– Permitted ambient temperature during operation	–10 °C to +50 °C	–10 °C to +50 °C
– Permitted ambient temperature during storage without a rechargeable battery	–20 °C to +70 °C	–20 °C to +70 °C
– Permitted ambient temperature during storage with a rechargeable battery	–20 °C to +50 °C	–
Recommended rechargeable batteries	GBA 10,8V... GBA 12V...	–
Recommended chargers	GAL 12...	–

A) Plus use-dependent deviation (e.g. reflection, distance, ambient temperature)

B) At an ambient temperature of +20 °C to +23 °C, an emissivity of > 0.999, measuring distance of 0.3 m, aperture of 60 mm

C) At an ambient temperature of +15 °C to +40 °C

D) Values in accordance with the Association of German Engineers' VDI/VDE 3511 part 4.3 standard (publication date July 2005); applies for 90 % of the measuring signal.

In all areas beyond the values detailed in the technical data, deviations are possible in measurement readings.

E) Refers to infrared measurement, see figure:

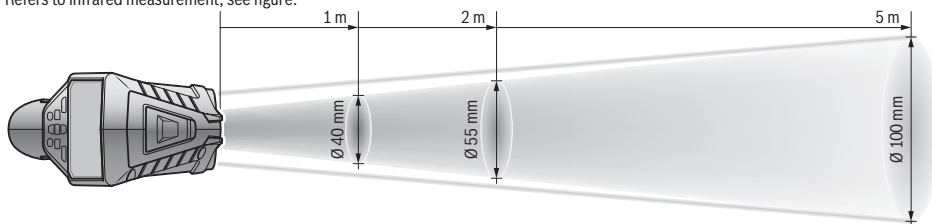

F) Only non-conductive deposits occur, whereby occasional temporary conductivity caused by condensation is expected.

G) Depends on battery in use

H) When using Bluetooth® Low Energy devices, it may not be possible to establish a connection depending on the model and operating system. Bluetooth® devices must support the SPP profile.

The serial number **(6)** on the type plate is used to clearly identify your measuring tool.

## Assembly

### Measuring Tool Power Supply

The measuring tool can be operated either with conventional non-rechargeable batteries or with a Bosch lithium-ion battery.

Article number **3 601 K83 371**: The measuring tool can only be operated using commercially available batteries.

### Operation With Non-Rechargeable Batteries (Not With Article Number 3 601 K83 371) (see figure B)

The batteries are inserted into the battery adapter.

- ▶ **The battery adapter is intended only for use in designated Bosch measuring tools and must not be used with power tools.**

To **insert** the batteries, slide the receptacle (27) of the battery adapter into the battery bay (29). Place the batteries in the receptacle as shown in the picture on the cap (28). Push the cap over the receptacle until you feel it click into place.



To **remove** the batteries, press the release buttons (3) on the cap (28) and pull the cap off. Hold the measuring tool with the battery bay (29) facing upwards to ensure that the batteries do not fall out when you do this. Remove the batteries. To remove the receptacle (27) from inside the battery bay, reach into the receptacle and pull it out of the measuring tool, applying light pressure to the side wall as you do so.

Always replace all the batteries at the same time. Only use batteries from the same manufacturer and which have the same capacity.

- ▶ **Take the batteries out of the measuring tool when you are not using it for a prolonged period of time.** The batteries can corrode and self-discharge during prolonged storage in the measuring tool.

#### Operation With Rechargeable Battery (Not With Article Number 3 601 K83 371) (see figure C)

- ▶ **Use only the chargers listed in the technical data.** Only these chargers are matched to the lithium-ion battery of your measuring tool.

**Note:** The use of batteries unsuitable for your measuring tool can lead to malfunctions or damage to the measuring tool.

**Note:** The battery is supplied partially charged. To ensure full capacity of the battery, completely charge the battery before the first use.

The lithium-ion battery can be charged at any time without reducing its service life. Interrupting the charging process does not damage the battery.

To **insert** the charged battery pack (30), slide it into the battery bay (29) until you feel it click into place and it is flush with the handle of the measuring tool.

To **remove** the battery pack (30), press the release buttons (3) and pull the battery pack out of the battery bay (29). **Do not use force to do this.**

#### Operation With Non-Rechargeable Batteries (3 601 K83 371) (see figure D)

Press the release buttons (3) to open the battery compartment cover (31) and then remove the battery compartment cover.

Make sure you insert the batteries the right way round according to the picture on the battery compartment cover.

Put the battery compartment cover (31) back on and gently push it until you feel it click into place.

Always replace all the batteries at the same time. Only use batteries from the same manufacturer and which have the same capacity.

- ▶ **Take the batteries out of the measuring tool when you are not using it for a prolonged period of time.** The batteries can corrode and self-discharge during prolonged storage in the measuring tool.

## Operation

### Starting Operation

- ▶ **Protect the measuring tool from moisture and direct sunlight.**
- ▶ **Do not expose the measuring tool to any extreme temperatures or variations in temperature.** For example, do not leave it in a car for extended periods of time. In case of large variations in temperature, allow the measuring tool to adjust to the ambient temperature before putting it into operation. The precision of the measuring tool may be compromised if exposed to extreme temperatures or variations in temperature.
- ▶ **Make sure that the measuring tool is correctly acclimatised.** In case of large variations in temperature, acclimatisation can take up to **60** minutes. This may be the case, for example, if you store the measuring tool in a cool car and then perform a measurement in a warm building.
- ▶ **Avoid hard knocks to the measuring tool or dropping it.** After severe external influences and in the event of abnormalities in the functionality, you should have the measuring tool checked by an authorised **Bosch** after-sales service agent.

### Switching on/off

Take the protective cap (21) off the infrared reception lens (23) and the protective cap (19) off the humidity and ambient temperature sensor (5). **Make sure that the camera (22), reception lens (23) and sensor (5) are not closed or covered when working, as this will affect the accuracy of the measurements taken.**

To **switch on** the measuring tool, press the on/off button (12) or the measure button (4). A start sequence will appear on the display (18). After the start sequence, the measuring tool will be in the operating mode that was saved the last time the tool was switched off. The lasers are not yet switched on.

Only upon the initial starting operation does the **<Tool>** menu also appear after the start sequence. In this menu, you can determine the settings of the measuring tool, such as the language of all displays (see "**<Tool>** submenu", page 15). Confirm the selected settings by pressing the right-hand function button (10). You can also change any of the settings later in the **<Tool>** submenu.

- ▶ **Never leave the measuring tool unattended when switched on, and ensure the measuring tool is switched off after use.** Others may be dazzled by the laser beam.
- ▶ **Do not direct the laser beam at persons or animals and do not stare into the laser beam yourself (even from a distance).**

In the factory setting, the brightness of the display lighting is reduced 30 s after each button press to save energy. Pressing any button will switch the display lighting back to full strength. In the **<Light Duration>** menu, you can change this lighting time (see "**<Light Duration>**", page 15).

To **switch off** the measuring tool, press the on/off button **(12)**. The measuring tool saves the current operating mode and the settings and then switches off. Put the protective cap **(21)** back on the reception lens **(23)** and put the protective cap **(19)** on the humidity and ambient temperature sensor **(5)**.

Do not switch off the measuring tool by removing the battery pack or battery adapter because this may damage the internal memory in certain cases.

In the main menu, you can set whether and after how long without button press/measurement the measuring tool automatically switches off (see "**<Shutdown Time>**", page 15). The current operating mode and the settings are also saved when the tool switches off automatically.

If the rechargeable battery or the measuring tool are outside the operating temperature specified in the Technical Data, the measuring tool will be switched off automatically after a short warning (see "Errors – causes and corrective measures", page 16). Allow the measuring tool to reach the correct temperature and then switch it back on.

## Measurement preparations

### Setting the emissivity for surface temperature measurements

To determine the surface temperature, the tool performs a contactless measurement of the natural infrared thermal radiation emitted by the object at which the tool is aimed. To ensure correct measurement, the emissivity setting on the measuring tool must be checked **before every measurement** and adapted to the measuring object if necessary. The preset emissivities in the measuring tool are reference values.

You can select one of the preset emissivity levels or enter an exact numerical value. Set the required emissivity via the **<Measurement>** → **<Emissivity value>** menu (see "**<Main Menu>**", page 14).

► **Correct temperature measurements are only possible if the set emissivity and emissivity of the object agree, and the correct reflected temperature is set.**

Otherwise, object temperatures could be shown to be hotter or colder than they are, which may present a danger if touched.

The lower the emissivity, the greater the effect of the reflected temperature on the measuring result. Always adjust the reflected temperature when changing the emissivity. Set the reflected temperature via the **<Measurement>** → **<Reflected Temp.>** menu (see "**<Main Menu>**", page 14).

If there are several objects with a different emissivity being measured within the measured area identified by the laser, the temperature measurement can be distorted.

### Measured area for surface temperature measurements

The laser points generated by the measuring tool border the exterior circular measured area. The displayed measured temperature value shows the average surface temperature within this area.

► **Do not direct the laser beam at persons or animals and do not stare into the laser beam yourself (even from a distance).**

Increasing the distance between the measuring tool and the object you are measuring will increase the distance between the laser points and consequently the size of the area measured.

If the laser points are difficult to recognise, you can switch on the **<Measuring Frame>** **(b)** on the display (see "**<Measuring Frame>**", page 15). The measuring frame can be used to indicate the area being measured and helps to improve orientation. The measuring frame may vary from the area being measured depending on the measuring distance. The area located between the laser points is decisive for the measurement.

### Information about the measuring conditions

Highly reflective, shiny or transparent surfaces (e.g. high-gloss tiles, stainless steel cupboard fronts or saucepans) may impair the surface temperature reading. If necessary, mask the area to be measured with a dark, matt adhesive tape that conducts heat well. Allow the tape to acclimatise briefly on the surface.

It is not technically possible to perform measurements through transparent materials.

Consequently, the more suitable and stable the measuring conditions are, the more accurate and reliable the results of the measurement will be.

The humidity and ambient temperature sensor **(5)** can be damaged by chemical contaminants, such as paint or varnish vapours. Infrared temperature measurement is impaired by smoke, vapour or dusty air.

It is therefore important to ventilate the room prior to measuring, especially when the air is contaminated or steamy. For example, do not perform measurements in a bathroom immediately after the shower has been used.

Once ventilated, allow the room to reacclimatise a while until it returns to the usual temperature.

The ambient temperature and relative humidity are measured directly on the measuring tool at the humidity and ambient temperature sensor **(5)**. To achieve meaningful results, do not hold the measuring tool directly over or next to sources of interference such as radiators or open liquids. Do not cover the sensor **(5)** under any circumstances.

Make sure that a favourable measuring angle is used on reflective surfaces in order to ensure that the thermal radiation reflected by other objects does not distort the result. For example, the reflection of your body heat may interfere with the measurement when measuring head-on from a perpendicular position.

### Setting the zoom level

For ongoing measurements and when rendering saved screenshots, the image detail on the display can be shown at 3 different zoom levels: 0.5 m, 2 m and 5 m.

The zoom levels are optimised for the corresponding distance between the measuring tool and the object being measured. At a measuring distance of 2 m, the zoom level "2 m" renders the (typically) best image detail.

The indicator for the current zoom level (**d**) is shown on the display. To increase the zoom level, press the "Zoom in" (up) arrow button (**16**); to decrease the zoom level, press the "Zoom out" (down) arrow button (**13**).

Due to the parallax, the measuring frame (**b**) only corresponds to the measuring range if the selected zoom level corresponds to the actual measuring distance.

### Illuminating the area you are measuring

When measuring in dark areas, you can switch on the light (**24**) to improve the display of the screen content. This can help you to achieve a better result when saving screenshots.

Press the button (**14**) to switch the light (**24**) on or off.

To save energy, the light switches off automatically when the brightness of the display lighting is reduced. You can change how long the display stays lit in the <Light Duration> menu (see "<Light Duration>", page 15). The light is not automatically switched on when the display lighting is switched back on.

For energy saving reasons, the light is not available when the battery pack's state of charge is in the critical range.

## Measuring functions

### Switching Between Individual Modes

Select the required mode with the right (**11**) or left (**15**) arrow buttons (the mode is displayed with a short explanation). To hide the explanation early, press the save button (**9**). To hide the explanation and immediately start a measurement, press the measure button (**4**).

### Surface temperature mode

Surface temperature mode is used to measure the surface temperature of objects.

In this mode, you can, for example, check radiators or look for overheated machine parts.

You start the measurement by pressing the measure button (**4**). The measured values shown on the display are continuously being updated. As soon as you let go of the measure button (**4**), the measurement is interrupted and the lasers are switched off. On the display, the last measurement results are fixed on the (**n**) indicator. The last measured surface temperature is displayed with the marking (**p**) on the result scale (**k**).

Once the difference between the measurements taken is more than 3 °C, the minimum and maximum temperatures measured during the process will appear on the display (**j**). This enables you to tell how high the current measured value is in relation to the temperatures already measured.

### Thermal bridge mode

The measuring tool can support you in detecting thermal bridges (see "Thermal bridge", page 16).

Before measurement can be started, the external temperature must first be set. To do so, open the <Main Menu> (see "Navigating in the <Main Menu>", page 14). Select the <Thermal Bridge> submenu and set the current external temperature. You start the measurement by pressing the measure button (**4**).

Taking into account the internal ambient temperature and the external temperature, you can determine whether the surface temperature meets the minimum requirements of the heat shield. If the surface temperature falls below the minimum requirements, a structural defect is assumed and a thermal bridge warning given.

Once the measurement has been taken, the surface temperature of the object you last measured is fixed on the display (**n**), as is the ambient temperature (**h**). The calculated  $f_{rsi}$  value (see "Thermal bridge", page 16) and its estimated tolerance are shown on the display (**v**).

The measuring tool displays the interpretation of the values with the marking (**p**) on the result scale (**k**):

- Marking (**p**) in the green range ( $f_{rsi}$  value over 0.7, including tolerance): No thermal bridge
- Marking (**p**) in the yellow range (borderline  $f_{rsi}$  value of 0.7): A thermal bridge may be in the measuring range. Measurement should be repeated under favourable environmental conditions (e.g. at a lower external temperature).
- Marking (**p**) in the red range ( $f_{rsi}$  value under 0.7, including tolerance): A thermal bridge is probably in the measuring range.

### Dew point mode

The measuring tool can support you in detecting places at risk of damage from mould.

The dew point temperature (see "Dew point temperature", page 17) is calculated from the additionally measured ambient temperature and relative air humidity (see "Relative humidity", page 17) in this mode. The dew point temperature is compared here with the measured surface temperature and interpreted in terms of the risk of mould formation.

Note that the measuring results always represent only a snapshot based on the current environmental conditions. A forecast for possibly changing environmental conditions cannot be made. If the measurement yields critical results, you should repeat the measurement at different times and under different conditions.

You start the measurement by pressing the measure button (**4**). The measured values shown on the display are continuously being updated.

Once the measurement has been taken, the surface temperature of the object you last measured is fixed on the display (**n**), as are the ambient temperature (**h**) and the relative humidity (**g**). The calculated dew point temperature is displayed in (**i**).

The measuring tool automatically helps in the interpretation of the values with the marking **(p)** on the result scale **(k)**:

- Marking **(p)** in the green range: There is no risk of mould under the current conditions.
- Marking **(p)** in the yellow range: The values are borderline; pay attention to the room temperature, thermal bridges and humidity, and repeat the measurement later if necessary.
- Marking **(p)** in the red range: There is an increased risk of mould because the humidity is too high or the surface temperature is close to the dew point temperature. The respective value flashes in the indicator.

A mould risk warning is given when the surface temperature is 80 % of the dew point temperature.

**Note:** Mould spores cannot be detected with the measuring tool. It only indicates that mould may form if the conditions remain unchanged.

### Contact Temperature Mode

Contact temperature measurement enables the temperature of an object to be measured directly using a commercially available type K shielded thermocouple.

The contact temperature measurement can be a helpful addition to the contactless temperature measurement. Use is particularly recommended in situations in which the infrared measurement has inherent disadvantages, e.g. when measuring temperature in media, liquids, air currents or surfaces with a low emissivity (polished metals).

There are specially optimised sensor geometries for various applications in liquids, in air currents or on surfaces, which allow correct measurement when using a suitable sensor.

Read and observe information from the thermocouple manufacturer if available.

Using a thermocouple principally requires direct contact with the object measured. Pay attention here to potential hazards and the safety instructions.

In this mode, only the temperature of the temperature sensor is measured. Other parameters are excluded here.

**Note:** Use type K shielded thermocouples only. Measurements may yield incorrect results if other types of thermocouples are connected.

Open the flap **(1)** and connect the thermocouple at the connection **(25)**.

As soon as a thermocouple is connected, the **(n)** indicator appears in the display. The measured value of the indicator is continually updated. For the measurement, the measure key **(4)** must not be pressed in this mode and the lasers are deactivated. To achieve a reliable result, wait for the measured value to stop changing. This can take several minutes depending on the version of thermocouple.

The contact temperature can, however, also be measured in every mode in addition to the surface temperature. Then the measured value is displayed in another place **(s)**. The surface temperature **(n)** is, however, always used to determine thermal bridges and the risk of mould.

When the thermocouple is removed, the function indicator **(s)** on the display goes out. Close the flap **(1)** again after removing the thermocouple.

### User mode

Surface temperature, ambient temperature and relative humidity are measured in user mode. The dew point temperature and the average temperature (average of the surface temperatures during the measuring period) are calculated from these.

You can hide the following values in the display as required: Average temperature, relative humidity, ambient temperature and dew point temperature.

To do so, open the **<Main Menu>** (see "Navigating in the **<Main Menu>**", page 14). Select the **<User Mode>** submenu. You can switch the indicators for **<Average Temp.>**, **<Humidity>**, **<Room Temp.>** and **<Dew Point>** on and off here.

For surface temperature measurements, you can choose whether the minimum and maximum values **(j)** of the result scale **(k)** are adapted automatically or defined manually. Go to the **<User Mode>** menu and then the **<Scale Range>** submenu.

- If you want the values **(j)** to be determined automatically as in surface temperature mode, select **<Auto>**. Once the difference between the measurements taken is more than 3 °C, the minimum and maximum temperatures measured during the process will appear on the display **(j)**.
- If you want to define the values manually, select **<Preset>**. Set the values you require in the **<User Mode>** menu under **<Scale Lower Limit>** and **<Scale Upper Limit>**. The minimum and maximum values you have set manually will appear on the display **(j)**. This enables screenshots of different measurements to be compared using the marking **(p)**, for example.

### Surface temperature alarm

The surface temperature alarm can be used in all modes except contact temperature measurement. You can set a minimum and a maximum temperature.

If the temperature is below the **minimum temperature**, the temperature alarm indicator **(m)** flashes blue and (if this feature is switched on) a warning signal sounds.

If the temperature is above the **maximum temperature**, the temperature alarm indicator **(m)** flashes red and (if this feature is switched on) a warning signal sounds.

To use the surface temperature alarm, open the **<Main Menu>** (see "Navigating in the **<Main Menu>**", page 14).

- Select the **<Alarm>** submenu.
- Set **<Alarm min/max>** to **<On>**.
- Set the minimum temperature under **<Alarm min>**.
- Set the maximum temperature under **<Alarm max>**.

The minimum and maximum temperatures will remain saved if you set the alarm to **<Off>**.

## Data transfer

### Saving/displaying/sending the results of a measurement

After measuring an object, the memory symbol appears on the display to indicate that you can save the results. Press the save/send button **(9)** to do this.

The results of the measurement are saved as a JPG file (screenshot of the fixed display).



- To **display** saved screenshots, press the left-hand function button **(17)** under the gallery symbol **(q)**. The most recently saved photo appears on the display.
- Press the right-hand **(11)** and left-hand **(15)** arrow buttons to scroll between the saved screenshots.
- To send the displayed measurement results via *Bluetooth*®, press the save/send button **(9)**. If *Bluetooth*® connectivity is not yet switched on (see "Data transfer via *Bluetooth*®", page 14), activate it by pressing the save/send button.



- To **delete** the displayed screenshot, press the right-hand function button **(10)** under the waste paper basket symbol.



- To confirm deletion, press the left-hand function button **(17)** under the tick symbol.



- To cancel deletion, press the right-hand function button **(10)** under the cross symbol.



- To exit the gallery view and return to measuring mode, press the left-hand function button **(17)** under the "Back" symbol.

You can also delete all the files saved at the same time (see "<Delete All Images>", page 15).

### Data Transfer via USB Port

Open the cover on the micro USB port **(1)**. Connect the micro USB port **(26)** of the measuring tool to your computer via the micro USB cable **(8)** provided.

Now press the on/off button **(12)** to switch on the measuring tool.

Open the file browser on your computer and select the **GIS 1000 C** drive. The saved files can be copied from the internal memory of the measuring tool, moved to your computer or deleted.

As soon as you have finished the required operation, disconnect the drive from the computer following the standard procedure and then use the on/off button **(12)** to switch the measuring tool off again.

**Caution:** Always disconnect the drive from your operating system first (eject drive), as failure to do so may damage the internal memory of the measuring tool.

Remove the micro USB cable **during** the measurement operation and close the cover **(1)**.

Always keep the flap of the USB port closed so that dust and splashes cannot enter the housing.

**Note:** Use USB to connect the measuring tool to a computer only. The measuring tool may be damaged if connected to other devices.

### Data transfer via Bluetooth®

The measuring tool is equipped with a *Bluetooth*® module which enables the data taken by your measuring tool to be wirelessly transmitted to a mobile device. Special Bosch applications (apps) are available for this use. These can be downloaded from the respective store of the device.



In addition to wireless data transfer, the Bosch applications make it possible for you to use an extended range of functions and facilitate post-editing and forwarding of measured data (e.g. via e-mail). Information about system requirements for a *Bluetooth*® connection can be found on the Bosch website at [www.bosch-professional.com/thermal](http://www.bosch-professional.com/thermal).

To switch on the *Bluetooth*® connection on the measuring tool, open the <Main Menu> (see "Navigating in the <Main Menu>", page 14) and set up <Bluetooth> <On>. The indicator **(e)** appears on the display. Ensure that the *Bluetooth*® interface is activated on your mobile device.

The mobile device and the measuring tool will be paired with each other when the Bosch application is started (providing the *Bluetooth*® modules are activated). If multiple active measuring tools are found, select the appropriate measuring tool. A connection will be established automatically if only one active measuring tool is found.

**Note:** When pairing the measuring tool with a mobile device (e.g. smartphone, tablet) for the first time, you may be prompted to enter a PIN code for the measuring tool. If you are, enter "0000".

When transferring data via *Bluetooth*®, poor reception conditions can cause time delays between the mobile device and the measuring tool.

### <Main Menu>

#### Navigating in the <Main Menu>



- To go to the <Main Menu> from the home screen, press the right-hand function button **(10)** under the menu symbol **(l)**.

- To navigate within a menu level, keep pressing the up arrow button **(16)** or the down arrow button **(13)** until the menu item you require is highlighted in colour.



- If there is a submenu for a highlighted menu item, this will be marked with an arrow pointing right next to <Set>. Press the right-

hand arrow button **(11)** to enter this submenu.



- If there are multiple options for a highlighted menu item, the current setting will be displayed between 2 arrows. Press the left-hand **(15)** or right-hand arrow button **(11)** to change this setting. Numerical values are changed faster if you keep the corresponding arrow button pressed.
- In some menu items you can switch a function on or off. To switch the function off, press the left-hand arrow button **(15)** so that **<Off>** is highlighted. To switch the function on, press the right-hand arrow button **(11)** so that **<On>** is highlighted. You can also switch the function on and off in the menu by pressing the save/send button **(9)**.



- To switch to a parent menu, press the left-hand function button **(17)** under the "Back" symbol. The selected settings will be saved.



- To exit the **<Main Menu>** and return directly to the home screen, press the right-hand function button **(10)** under the house symbol. The selected settings will be saved.



- To exit any menu and return to the home screen, you can also press the measure button **(4)**. If this button is pressed once, the selected settings will be saved but measurement will not be initiated.

## Measurement Submenu

### <Emissivity value> (t)

A selection of saved emissivities is available for some of the most common materials. To make the search easier, the values are combined into groups in the emissivity catalogue. First select the relevant category and then choose the relevant material in the **<Material>** menu item. The corresponding emissivity is shown in the line beneath. If you know the exact emissivity of the object being measured, you can also set it as a numerical value in the **<Emissivity value>** menu item.

If you frequently measure the same materials, you can enter 5 emissivities as favourites and quickly call them up via the bar at the top (numbered from 1 to 5).

### <Reflected Temp.> (t)

Setting this parameter can improve the accuracy of the measuring result, especially with low-emissivity (= high-reflection) materials. In some situations (especially in indoor areas), the reflected temperature corresponds to the ambient temperature. If there are objects with greatly deviating temperatures close to highly reflective objects, this value should be adjusted as the measurement may be affected.

### <Tool> submenu

Call up the **<Main Menu>** and select the **<Tool>** submenu. This contains the following menu items.

### <Language>

In the **<Language>** menu, you can change the language of all the indicators on the display.

### <Time & Date>

To change the time and date shown on the display **(a)**, call up the **<Time & Date>** submenu. This submenu also allows you to change the time and date format.

To exit the **<Time & Date>** submenu, press either the left function button **(17)** to save the settings, or the right function button **(10)** to discard the changes.

### <Unit>

In the **<Unit>** menu, you can choose whether the temperatures are displayed in **<°C>** or **<°F>**.

### <Laser>

In the **<Laser>** menu, you can switch on or off the measuring tool laser. The laser acts as a boundary for the measured area and should, therefore, only be deactivated in exceptional cases.

### <Measuring Frame>

In the **<Measuring Frame>** menu, you can switch the measuring frame **(b)** on the display on and off.

### <Colour Scheme>

In the **<Colour Scheme>** menu, you can choose the colour of the temperatures and other indicators on the display. The setting will also be applied to saved screenshots.

### <Shutdown Time>

In the **<Shutdown Time>** menu, you can specify after how long the measuring tool will switch off automatically if you do not press any buttons. You can also deactivate automatic switch-off by selecting the **<Never>** setting. The shorter the automatic switch-off time, the more energy you can save.

### <Light Duration>

In the **<Light Duration>** menu, you can specify after how long the display lighting will dim if you do not press any buttons on the measuring tool. You can also choose to have the display lit permanently by selecting the **<Always>** setting. The shorter the display illumination time, the more energy you can save.

### <Audio Signals>

In the **<Audio Signals>** menu, you can switch the surface temperature alarm sound on and off.

### <Delete All Images>

In the **<Delete All Images>** menu, you can delete all the files in the internal memory at the same time. Press the right-hand arrow button **(11)** for **<More>** to enter this submenu. Then press either the right function button **(10)** to delete all files or the left function button **(17)** to cancel the process.

### <Tool Information>





For information about the measuring tool, call up the **<Tool Information>** submenu. There you will find the serial number of the measuring tool and the installed software version.

### <Factory settings>

Under this menu item, you can reset the measuring tool to factory settings and permanently delete all data. This may take several minutes. Press the right-hand arrow button **(11)** for **<More>** to enter this submenu. Then press

either the right function button **(10)** to delete all files or the left function button **(17)** to cancel the process.

### Errors – causes and corrective measures

Error	Cause	Corrective measures
Measuring tool cannot be switched on.	Battery pack or batteries empty	Charge the battery pack or change the batteries.
	Battery pack too hot or too cold	Allow the battery pack to reach the correct temperature or change it.
	Image memory defective	Format the internal memory by deleting all images (see "<Delete All Images>", page 15). If the problem persists, send the measuring tool to an authorised Bosch after-sales service centre.
	Image memory full	Transfer the images to another storage medium (e.g. computer or Notebook) when necessary. Then delete the images in the internal memory.
	Measuring tool faulty	Send the measuring tool to an authorised Bosch after-sales service centre.
Function indicator <b>(s)</b> for contact temperature measurement does not appear on the display.	Connection <b>(25)</b> for thermocouple or the thermocouple is defective	Check the function of the thermocouple and send the measuring tool to an authorised Bosch after-sales service centre.
Measuring tool cannot be connected to a computer.	Measuring tool not recognised by computer.	Check whether the driver on your computer is up to date. It may be necessary to have a newer operating system version on your computer.
	Micro USB port or Micro USB cable defective	Check whether the measuring tool can be connected to a different computer. If not, send the measuring tool to an authorised Bosch after-sales service centre.
	Humidity and ambient temperature sensor <b>(5)</b> defective	The other functions of the measuring tool can still be used. Send the measuring tool to an authorised Bosch after-sales service centre.

### Glossary of terms

#### Infrared thermal radiation

Infrared thermal radiation is electromagnetic radiation emitted by every body above 0 Kelvin (-273 °C). The amount of radiation depends on the temperature and the emissivity of the body.

#### Emissivity

The emissivity of an object depends on the material and the structure of its surface. This specifies how much infrared thermal radiation the object emits compared with an ideal radiant warmer (black body, emissivity  $\epsilon = 1$ ) and accordingly has a value between 0 and 1.

#### Reflected Temperature/Reflectivity of an Object

The reflected temperature is the thermal radiation that is not emitted by the object itself. Depending on the structure and material, background radiation is reflected in the object to be measured, therefore distorting the actual temperature result.

#### Thermal bridge

A thermal bridge is defined as a position on the external wall of a building, where there is a localised increase in heat loss due to a structural defect.

In order to evaluate the thermal bridges, the minimum requirement of a heat shield outlined according to DIN 4108-2 can be used.

According to DIN 4108-2, the minimum requirement of a heat shield is met if the temperature factor  $f_{Rsi}$  is larger than **0.7**.

The temperature factor  $f_{Rsi}$  is calculated as follows:



$$f_{\text{Rsi}} = \frac{T_1 - T_2}{T_3 - T_2}$$

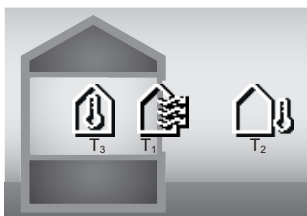

$T_1$ : Internal surface temperature  
 $T_2$ : External temperature  
 $T_3$ : Internal ambient temperature

The minimum heat shield acts to avoid mould under standard boundary conditions. This avoids buildings being put in danger.

Under standard conditions (external temperature of  $-5\text{ }^{\circ}\text{C}$ , internal ambient temperature of  $20\text{ }^{\circ}\text{C}$ ), the surface temperature should not fall under  $12.6\text{ }^{\circ}\text{C}$ . This corresponds to an  $f_{\text{Rsi}}$  limit value of 0.7. For as meaningful a result as possible (small uncertainty), the external temperature should be under  $10\text{ }^{\circ}\text{C}$ .

### Relative humidity

The relative humidity indicates the degree to which the air is saturated with water vapour. The value is indicated as a percentage of the maximum amount of water vapour the air can absorb. The maximum amount of water vapour depends on the temperature: The higher the temperature is, the more water vapour the air can absorb.

If the relative humidity is too high, there is an increased risk of mould. If the relative humidity is too low, it may have a negative impact on your health.

### Dew point temperature

The dew point temperature indicates the point at which the water vapour in the air starts to condense. The dew point temperature depends on the relative humidity and the air temperature.

If the temperature of a surface is below the dew point temperature, water will start to condense on this surface.

Condensate on surfaces is one of the main reasons why mould forms.

## Maintenance and Service

### Maintenance and Cleaning

Keep the measuring tool clean at all times. A dirty infrared reception lens (23) may impair the measuring accuracy.

Wipe off any dirt using a dry, soft cloth. Do not use any detergents or solvents.

When cleaning the measuring tool, ensure that no liquids enter the tool.

Clean the humidity and temperature sensor (5), camera (22), reception lens (23), light (24) and laser outlet aperture (2) particularly carefully. Make sure that there is no lint on the camera, reception lens or laser beam outlet apertures. Only clean the camera, reception lens and laser beam outlet apertures with cleaning products that are also suitable

for camera lenses. Do not attempt to remove dirt from the sensor, camera or reception lens using pointed objects, and do not wipe over the camera and reception lens (risk of scratching).

Do not store the measuring tool for extended periods where the atmospheric humidity is outside the range of 30 % to 50 %. If the measuring tool is stored in conditions that are too damp or too dry, it can result in inaccurate readings.

The air humidity sensor is inherently sensitive to solvents, adhesives and softeners. Being influenced by such substances in the long term can lead to deviations in the measured air humidity.

Do not store the measuring tool in a plastic bag, as the evaporation could damage the humidity and temperature sensor (5). Do not affix any stickers near to the sensor on the measuring tool.

Please contact an authorised Bosch after-sales service centre if you want to have your measuring tool recalibrated. Only store and transport the measuring tool in the protective bag provided.

If the measuring tool needs to be repaired, send it off in the protective bag.

### After-Sales Service and Application Service

Our after-sales service responds to your questions concerning maintenance and repair of your product as well as spare parts. You can find explosion drawings and information on spare parts at: [www.bosch-pt.com](http://www.bosch-pt.com)

The Bosch product use advice team will be happy to help you with any questions about our products and their accessories.

In all correspondence and spare parts orders, please always include the 10-digit article number given on the nameplate of the product.

#### India

Bosch Service Center  
 69, Habibullah Road, (Next to PSBB School), T. Nagar  
 Chennai – 600077  
 Phone: (044) 64561816

Bosch Service Center  
 18, Community Center  
 Phase 1, Mayapuri  
 New Delhi – 110064  
 Phone: (011) 43166190

Bosch Service Center  
 Shop no 7&8, Aspen garden  
 Walbhat road , Goregaon (E)  
 Near to Ram Mandir Railway Station  
 Mumbai – 400063  
 Mobile: 09819952950

#### Malaysia

Robert Bosch Sdn. Bhd.(220975-V) PT/SMY  
 No. 8A, Jalan 13/6  
 46200 Petaling Jaya  
 Selangor  
 Tel.: (03) 79663194  
 Toll-Free: 1800 880188

Fax: (03) 79583838  
E-Mail: kiathoe.chong@my.bosch.com  
www.bosch-pt.com.my

#### Israel

Ledico Ltd.  
31 Lazrov Street  
P.O. Box 6018 Rishon Le Ziyon  
service@ledico.com

#### Korea

Tel.: 080-955-0909 (Hotline)

#### You can find further service addresses at:

www.bosch-pt.com/serviceaddresses

#### Transport

The contained lithium-ion batteries are subject to the Dangerous Goods Legislation requirements. The batteries are suitable for road-transport by the user without further restrictions.

When shipping by third parties (e.g.: by air transport or forwarding agency), special requirements on packaging and labelling must be observed. For preparation of the item being shipped, consulting an expert for hazardous material is required.

Dispatch battery packs only when the housing is undamaged. Tape or mask off open contacts and pack up the battery in such a manner that it cannot move around in the packaging. Please also observe the possibility of more detailed national regulations.

#### Disposal



Measuring tools, rechargeable/non-rechargeable batteries, accessories and packaging should be sorted for environmental-friendly recycling.



Do not dispose of the measuring tools or rechargeable/non-rechargeable batteries with household waste.

#### Only for EU countries:

According to the Directive 2012/19/EU, measuring tools that are no longer usable, and according to the Directive 2006/66/EC, defective or used battery packs/batteries, must be collected separately and disposed of in an environmentally correct manner.

#### Battery packs/batteries:

##### Li-ion:

Please observe the notes in the section on transport (see "Transport", page 18).

## 中文

### 安全规章



必须阅读并注意所有说明，以安全可靠地操作测量仪。如果不按照给出的说明使用测量仪，可能会影响集成在测量仪中的保护功能。测量仪上的警戒牌应保持清晰可读的状态。请妥善保存本说明书，并在转交测量仪时将本说明书一起移交。

- ▶ 小心 - 如果使用了与此处指定的操作或校准设备不同的设备，或执行了不同的过程方法，可能会导致危险的光束泄露。
- ▶ 本测量仪交付时带有一块激光警戒牌（在测量仪示意图的图形页中标记）。
- ▶ 如果激光警戒牌的文字并非贵国语言，则在第一次使用前，将随附的贵国语言的贴纸贴在警戒牌上。



不得将激光束指向人或动物，请勿直视激光束或反射的激光束。可能会致人炫目、引发事故或损伤眼睛。

- ▶ 如果激光束射向眼部，必须有意识地闭眼，立即从光束位置将头移开。
- ▶ 请不要对激光装置进行任何更改。
- ▶ 激光视镜（附件）不得用作护目镜。激光视镜用于更好地识别激光束；然而对激光束并没有防护作用。
- ▶ 激光视镜（附件）不得用作太阳镜或在道路交通中使用。激光视镜并不能完全防护紫外线，还会干扰对色彩的感知。
- ▶ 仅允许由具备资质的专业人员使用原装备件修理测量仪。如此才能够确保测量仪的安全性能。
- ▶ 不得让儿童在无人看管的情况下使用激光测量仪。可能意外地让他人或自己炫目。
- ▶ 请勿在有易燃液体、气体或粉尘的潜在爆炸性环境中使用测量仪。测量仪器内可能产生火花并点燃粉尘和气体。
- ▶ 切勿打开充电电池。可能造成短路。
- ▶ 如果充电电池损坏或者未按照规定使用，充电电池中会散发出有毒蒸汽。充电电池可能会燃烧或爆炸。工作场所必须保持空气流通，如果身体有任何不适必须马上就医。蒸汽会刺激呼吸道。
- ▶ 如果充电电池使用不当或者损坏，可能会有易燃的电解液从充电电池中流出。避免与之接触。如果意外碰到，用水冲洗。如果电解液碰到眼睛，还要寻求医疗帮助。从充电电池流出的液体会刺激或灼伤皮肤。
- ▶ 钉子、螺丝刀等尖锐物品或外力作用可能会损坏充电电池。有可能出现内部短路、蓄电池燃烧、发出烟雾、爆炸或过热。
- ▶ 当电池盒不用时，将它远离其他金属物体，例如回形针、硬币、钥匙、钉子、螺钉或其他小金属物体，以防一端与另一端连接。电池端部短路会引起燃烧或火灾。

- ▶ **只能将此充电电池用在制造商的产品中。** 这样才能确保充电电池不会过载。
- ▶ **请只用制造商推荐的充电器充电。** 不可以使用针对某些特定蓄电池的充电器，为其它的蓄电池充电，可能引起火灾。



**保护充电电池免受高温（例如长期阳光照射）、火焰、脏污、水和湿气的侵害。有爆炸和短路的危险。**

- ▶ **在测量仪上进行任何工作（例如安装、维护等）以及搬运、保存测量仪之前，都必须从设备中取出电池或蓄电池。** 无意间操作起停开关可能会造成伤害。
- ▶ **注意！** 在使用配有**蓝牙®**的测量仪时，其它装置和设备、飞机和医疗器械（例如心脏起搏器、助听器）可能会出现故障。同样不能完全排除周围的人 and 动物会受到伤害。请不要在医疗设备、加油站、化工厂、有爆炸危险的地区附近和在爆破区内使用配有**蓝牙®**的测量仪。请不要在飞机上使用配有**蓝牙®**的测量仪。请避免在身体附近较长时间使用。

**蓝牙®**文字标记和图形符号（标志）是Bluetooth SIG公司的注册商标和财产。Robert Bosch Power Tools GmbH根据许可可使用这些文字标记/图形符号。

- ▶ **保护好测量仪，尤其是避免空气湿度传感器、环境温度传感器和红外线传感器区域受到湿气、雨雪、灰尘和脏污的影响。** 接收镜头可能会蒙上一层雾气或脏污，使测量结果失真。错误的设备设置及其它环境影响因素可能会导致测量错误。显示的物体温度可能会过高或过低，因而当触摸物体时可能会发生危险。
- ▶ **只有当设置的辐射率和物体辐射率一致时以及设置好正确的反射温度后，才能正确测量温度。** 显示的物体温度可能会过高或过低，因而当触摸物体时可能会发生危险。

### 有关使用热电偶的安全规章

- ▶ **热电偶不得在带电设备中使用。会有生命危险！**
- ▶ **使用热电偶时会接触测量物体。** 因此，请注意因温度、电压或化学反应引起的潜在危险。

## 产品和性能说明

请注意本使用说明书开头部分的图示。

### 按照规定使用

本测量仪用于以非接触方式测量表面温度、环境温度和空气相对湿度。计算露点温度并提示热桥和发霉风险。无法用本测量仪检测到霉菌孢子。不过，有助于及时发现可以促进霉菌生长的条件。

不允许使用本测量仪测量人体和动物的温度或用于其他医疗目的。

本测量仪不适用于测量气体的表面温度。

只能借助常用的热电偶（接口类型K）测量液体中的温度，为此可以通过指定的接口**(25)**连接到测量仪上。

利用一个热电偶也可以通过接触表面进行表面温度测量。

本测量仪的灯光旨在照亮测量仪的直接工作区域，以便进行拍照。

激光点不得用作激光笔。仅用于标记测量面。

本测量仪适合在室内和室外使用。

### 插图上的机件

机件的编号和仪器详解图上的编号一致。

- (1) Micro-USB插口盖子/热电偶接口（类型K）
- (2) 激光束发射口
- (3) 充电电池/蓄电池适配器/电池盒盖的解锁按键
- (4) 测量按键/起停开关
- (5) 空气湿度和环境温度传感器
- (6) 序列号
- (7) 激光警示牌
- (8) Micro-USB线
- (9) 保存/发送按键（**蓝牙®**）
- (10) 右侧功能键
- (11) 向右箭头键
- (12) 电源开关
- (13) 向下箭头键/减小放大倍数
- (14) 灯电源开关
- (15) 向左箭头键
- (16) 向上箭头键/增大放大倍数
- (17) 左侧功能键
- (18) 显示屏
- (19) 空气湿度和环境温度传感器保护盖
- (20) 拎环固定座
- (21) 红外接收镜头保护盖
- (22) 摄像头
- (23) 红外辐射接收镜头
- (24) 灯
- (25) 用于热电偶的K型接口
- (26) Micro-USB插口
- (27) 电池适配器外壳<sup>a)</sup>
- (28) 蓄电池适配器密封帽<sup>a)</sup>
- (29) 电池盒
- (30) 充电电池<sup>a)</sup>
- (31) 电池盒盖<sup>a)</sup>

a) 图表或说明上提到的附件，并不包含在基本的供货范围中。本公司的附件清单中有完整的附件供应项目。

### 显示元件（参见插图 A）

- (a) 日期/时间（参见“<时间/日期>”，页 26）
- (b) 测量框架（参见“进行表面温度测量时的测量面”，页 23）
- (c) 状态指示灯：



测量仪测量准备就绪，按压测量按钮(4)。



(连续) 测量正在进行，激光器已接通。



测量已结束，激光已关闭，测量结果固定。



接触温度模式，激光器已停用，正在通过热电偶进行测量。

(d) 放大倍数显示(参见“调整放大倍数”，页 23)

(e) 蓝牙® (指示灯) 已接通(参见“通过蓝牙®传输数据”，页 25)

(f) 蓄电池充电电量指示灯

(g) 功能显示/空气相对湿度测量值

(h) 功能显示/环境温度测量值

(i) 功能显示/露点温度结果

(j) 测量过程中表面温度的最小/最大测量值

(k) 结果刻度

(l) 菜单图标

(m) 表面温度警告显示(参见“表面温度警告”，页 24)

(n) 测量值

(o) 当前模式

(p) 标记测量值或结果(视选择的模式而定)

(q) 图片集图标

(r) 功能显示/平均温度测量值

(s) 功能显示/接触温度测量值

(t) 辐射率显示/反射温度

(u) 设置的外部温度(热桥模式)

(v)  $f_{R_{SI}}$  值及公差显示(热桥模式)

## 技术参数

测温器	GIS 1000 C	GIS 1000 C
物品代码	<b>3 601 K83 3..</b>	<b>3 601 K83 371</b>
工作范围	0.1-5米	0.1-5米
测量范围		
- 表面温度	-40至+1000摄氏度	-40至+1000摄氏度
- 接触温度	-40至+1000摄氏度	-40至+1000摄氏度
- 使用环境温度	-10至+50摄氏度	-10至+50摄氏度
- 空气相对湿度	0至100%	0至100%
测量精度 <sup>A)</sup>		
表面温度 <sup>B)</sup>		
-40至-20.1摄氏度	±2.5摄氏度	±2.5摄氏度
-20至-0.1摄氏度	±1.5摄氏度	±1.5摄氏度
<b>0至+100摄氏度</b>	<b>±1摄氏度</b>	<b>±1摄氏度</b>
+100摄氏度至+400摄氏度	±1%	±1%
> +400摄氏度	±2%	±2%
环境温度	±1摄氏度	±1摄氏度
空气相对湿度 <sup>C)</sup>		
<20%	±3%	±3%
<b>20至60%</b>	<b>±2%</b>	<b>±2%</b>
60至90%	±3%	±3%
镜头(测量距离与测量点之比) <sup>D)E)</sup>	50:1	50:1
激光等级	2	2
激光种类	635纳米, <1毫瓦	635纳米, <1毫瓦
发散角(全角)	<1.5毫弧度	<1.5毫弧度
基准高度以上的最大使用高度	2000米	2000米
脏污程度符合IEC 61010-1	2 <sup>F)</sup>	2 <sup>F)</sup>
最大空气相对湿度	90%	90%
电池(碱-锰)	4 × 1.5伏特LR6 (AA) (带电池适配器)	4 × 1.5伏特LR6 (AA)

测温器	GIS 1000 C	GIS 1000 C
充电电池 (锂离子)	10.8伏特/12伏特	-
操作时间		
- 电池 (碱-锰)	3小时	3小时
- 充电电池 (锂离子) <sup>G)</sup>	10小时	-
内部图像存储器中的图像数量	> 200	> 200
蓝牙® (经典和低能耗)	4.2 <sup>H)</sup>	4.2 <sup>H)</sup>
工作频率范围	2402-2480兆赫	2402-2480兆赫
最大发送功率	2.5毫瓦	2.5毫瓦
USB接头	2.0	2.0
重量符合EPTA-Procedure 01:2014 <sup>G)</sup>	0.56-0.77千克	0.51千克
尺寸 (长x宽x高)	136 × 89 × 214毫米	136 × 89 × 214毫米
环境条件		
- 充电时建议的环境温度	0摄氏度至+35摄氏度	-
- 运行时允许的环境温度	-10摄氏度至+50摄氏度	-10摄氏度至+50摄氏度
- 不带充电电池存放时允许的环境温度	-20摄氏度至+70摄氏度	-20摄氏度至+70摄氏度
- 带充电电池存放时允许的环境温度	-20摄氏度至+50摄氏度	-
推荐的充电电池	GBA 10,8V... GBA 12V...	-
推荐的充电器	GAL 12...	-

A) 加上与使用相关的偏差 (比如反射、距离、环境温度)

B) 当环境温度在+20摄氏度至+23摄氏度之间、辐射率大于0.999、测量距离为0.3米、孔径为60毫米时

C) 当环境温度在+15摄氏度至+40摄氏度之间

D) 参照VDI/VDE 3511表4.3 (发布日期: 2005年7月)的说明; 适用于90%的测量信号。  
除了技术参数中所示的尺寸, 在所有区域中均可能出现与测量结果的偏差。

E) 针对红外测量, 见图:

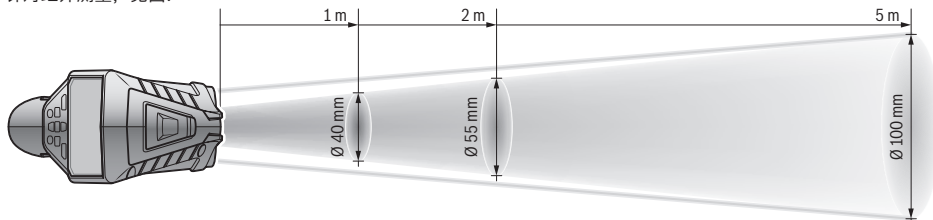

F) 仅出现非导电性污染, 不过有时会因凝结而暂时具备导电性。

G) 视所使用的充电电池而定

H) 对于蓝牙®低能耗设备, 视型号和操作系统而定可能无法建立连接。蓝牙®设备必须支持SPP协议。

型号铭牌上的序列号(6)是您的测量仪的唯一识别号。

## 安装

### 测量仪电源

本测量仪可以使用一般的电池也可以使用博世锂离子蓄电池。

物品代码**3 601 K83 371**: 只能用市售电池运行测量仪。

**通过蓄电池驱动 (物品代码3 601 K83 371不适用) (参见插图B)**

电池应装在在电池适配器中。

### ▶ 电池适配器仅用于特定的博世测量仪, 不允许配合电动工具使用。

如要装入蓄电池, 请将电池适配器的外壳(27)推入电池仓(29)中。根据密封帽(28)上的图示将蓄电池放入外壳中。将密封帽推到外壳上, 直至听到卡止声。



如要取出蓄电池, 请按压密封帽(28)的解锁按键(3), 然后拔下密封帽。注意电池不要掉出。支撑住测量仪, 向上对准电池仓(29)。取出电池。如要取出电池仓内部的外壳(27), 则将手伸入外壳中, 然后轻轻按压侧壁将其从测量仪中取出。

务必同时更换所有的电池。请使用同一制造厂商生产的相同容量电池。

- ▶ **长时间不用时，请将电池从测量仪中取出。**在长时间存放于测量仪中的情况下，蓄电池可能会腐蚀以及自行放电。

**通过充电电池驱动（物品代码3 601 K83 371不适用）（参见插图C）**

- ▶ **请只使用在技术参数中列出的充电器。**只有这些充电器才与可用在本测量仪上的锂离子蓄电池相匹配。

**提示：**如果使用的充电电池与测量仪不匹配，则可能会导致功能失灵或测量仪损坏。

**提示：**充电电池在交货时只完成部分充电。首次使用测量仪之前，必须先充足充电电池的电量以确保充电电池的功率。

可以随时为锂离子蓄电池充电，不会缩短电池的使用寿命。如果充电过程突然中断，也不会损坏电池。如要装入已充电的充电电池(30)，请将该电池推入电池仓(29)中，直至能感觉到它卡入且与测量仪手柄齐平。

如要取出充电电池(30)，请按压解锁按键(3)，然后将充电电池从电池仓(29)中拔出。**在此过程中请勿过度用力。**

**通过蓄电池驱动（3 601 K83 371）（参见插图D）**

请按压解锁按键(3)以打开电池盒盖(31)，然后取下电池盒盖。

安装蓄电池时，请根据电池盒盖上的图示，注意电极是否正确。

再次装上电池盒盖(31)，直至感觉到卡入。

务必同时更换所有的电池。请使用同一制造厂商生产的相同容量电池。

- ▶ **长时间不用时，请将电池从测量仪中取出。**在长时间存放于测量仪中的情况下，蓄电池可能会腐蚀以及自行放电。

## 运行

### 投入使用

- ▶ **不可以让湿气渗入仪器中，也不可以让阳光直接照射在仪器上。**
- ▶ **请勿在极端温度或温度波动较大的情况下使用测量仪。**比如请勿将测量仪长时间放在汽车内。温度波动较大的情况下，使用测量仪之前先使其温度稳定下来。如果仪器暴露在极端的气候下或温差相当大的环境中，会影响仪器的测量准确度。
- ▶ **注意测量仪正确的气候适应性。**温度波动较大时，气候适应时长最多为60分钟。比如，如果将测量仪存放在温度较低的车中，然后在温暖的建筑中进行测量，则可能是这种情况。
- ▶ **避免测量仪剧烈碰撞或掉落。**在发生强烈的外界作用后以及功能异常时，应将测量仪交由授权的Bosch售后服务点进行检查。

### 接通/关闭

取下红外接收镜头(23)的保护盖(21)及空气湿度和环境温度传感器(5)的保护盖(19)。在工作中**请注意不要封闭或遮挡摄像头(22)、接收镜头(23)和传感器(5)，否则无法正确测量。**

如要**接通**测量仪，请按压电源开关(12)或测量按键(4)。在显示屏(18)中显示启动序列。启动序列后，测量仪以上次关闭时保存的运行模式启动。激光器尚未接通。

仅在首次运行时，在启动序列后显示菜单<设备>，通过该菜单可以确定测量仪的设置，比如所有显示的语言(参见“子菜单<设备>”，页26)。通过按压右侧功能键(10)确认所选的设置。也可以在子菜单<设备>中对所有设置进行后续更改。

- ▶ **测量仪接通后应有人看管，使用后应关闭。**激光可能会让旁人炫目。

- ▶ **不得将激光束对准人或动物，也请勿直视激光束，即使和激光束相距甚远也不可以做上述动作。**

在出厂设置中，出于节能考虑，每次按压按键30秒后就会降低显示屏亮度。按压任意按键，显示屏以最大亮度再次接通。可在菜单<照明时长>中更改照明时间(参见“<照明时长>”，页26)。

如要**关闭**测量仪，请按压电源开关(12)。测量仪保存当前运行模式以及设置，然后自动关闭。将保护盖(21)再次放到接收镜头(23)上，并将保护盖(19)放到空气湿度和环境温度传感器(5)上。

请勿通过取下充电电池或蓄电池适配器来关闭测量仪，因为在不利情况下可能损坏内部存储器。

您可以在主菜单中设置是否以及多久之后在不按压按键/测量的情况下自动关闭测量仪(参见“<关闭时间>”，页26)。自动关闭时也会保存当前运行模式以及设置。

如果充电电池或测量仪超出技术参数规定的工作温度，则测量仪在短促警告(参见“故障 - 原因和补救措施”，页26)后自动关闭。使测量仪冷却，然后再次接通。

### 测量准备

#### 调整表面温度测量的辐射率

要确定表面温度，请以非接触方式测量所显示物体发射出的天然红外热辐射。为了确保正确测量，必须在**每次测量前**检查测量仪上设置的辐射率，必要时与测量物体进行匹配。

测量仪中预设的辐射率为基准值。

您可以选择一个预设好的辐射率，或者输入一个具体的数值。通过菜单<测量>→<辐射率>设置所需的辐射率(参见“<主菜单>”，页25)。

- ▶ **只有当设置的辐射率和物体辐射率一致时以及设置好正确的反射温度后，才能正确测量温度。**显示的物体温度可能会过高或过低，因而当触摸物体时可能会发生危险。

辐射率越小，反射温度对测量结果的影响越大。因此，在更改辐射率时务必调整反射温度。通过菜单<测量>→<反射温度>调整反射温度(参见“<主菜单>”，页25)。

如果激光器标出的测量面内有多个辐射率不同的测量物体，则温度测量可能会失真。

#### 进行表面温度测量时的测量面

测量仪生成的激光点从外面圈住圆形测量面。显示的温度测量值为该区域内的平均表面温度。

▶ **不得将激光束对准人或动物，也请勿直视激光束，即使和激光束相距甚远也不可以做上述动作。**

激光点之间的距离以及测量面的大小随着测量仪和测量物体之间距离的增大而增大。

如果很难检测到激光点，则可以接通显示屏中的**<测量框> (b)** (参见“<测量框>”，页 26)。测量框架可以用作测量面的指示器，用于更好地定向。视测量距离而定，测量框架可能偏离测量面。激光点之间的区域对测量来说至关重要。

#### 测量条件提示

高反射的光亮表面或透明表面（例如光亮的瓷砖、不锈钢端面或烹饪锅）可能影响表面温度测量。必要时，用导热良好的深色亚光胶带贴住测量面。让胶带短暂地在表面上调温。

受原理限制，无法通过透明的材料进行测量。

测量条件越好越稳定，测量结果就越确切可靠。

空气湿度和环境温度传感器(5)可能会被化学有害物质（比如清漆或油漆的蒸汽）损坏。烟、蒸汽或含有粉尘的空气将影响红外温度测量。

因此要在测量前为室内通风，尤其是当空气较脏或含有水汽时。比如不要在淋浴后立即在浴室内进行测量。

通风后使房间调温一会儿，直至重新达到常温。

环境温度和空气相对湿度直接通过空气湿度和环境温度传感器(5)上的测量仪测量。为获得有效的测量结果，请勿将测量仪直接放在干扰源（比如加热装置或敞开的液体）上方或附近。切勿遮盖传感器(5)。

对于反射表面请确保良好的测量角度，这样其它物体的反射热辐射不会使测量结果失真。例如，从前面垂直测量时，您的体热反射会影响测量。

#### 调整放大倍数

连续测量以及回放存储的屏幕截图时，显示屏中的图像可以分3个放大倍率进行显示：0.5米、2米和5米。

放大倍率针对测量仪和测量物体之间的相应距离进行了优化：当测量距离为2米时，放大倍率“**2米**”（通常）显示的图像最佳。

显示(d)中出现当前的放大倍率。如要增大放大倍率，请按压增大放大倍率箭头键(16)，如要减小放大倍率，请按压减小放大倍率箭头键(13)。

由于视差，只有当选定的放大倍率与实际测量距离相符时，测量框架(b)才与测量范围相协调。

#### 照亮测量面

在黑暗区域中进行测量时，您可以打开灯(24)以改善屏幕内容的显示。保存屏幕截图时，这可以帮助您获得更好的结果。

接通或关闭灯(24)时，请按压按键(14)。

出于节能考虑，当显示屏的亮度降低时，灯自动关闭。可在菜单**<照明时长>**中更改照明时间(参见“<照明时长>”，页 26)。再次接通显示屏照明灯时，灯不会自动接通。

当充电电池的电量处于临界范围内时，出于节能考虑，灯不可用。

## 测量功能

### 在各个模式之间切换

通过右侧箭头键(11)或左侧箭头键(15)选择所需的模式（通过简短的说明显示模式）。如要提前隐藏该说明，请按压保存键(9)。如要隐藏说明和立即启动测量，请按压测量按键(4)。

### 表面温度模式

在表面温度模式中测量测量物体的表面温度。

在该模式中可以检查散热器等或搜索过热的机器部件。

通过按压测量按键(4)启动测量。显示屏中显示的测量值持续更新。一旦松开测量按键(4)，则测量中断，激光器关闭。显示(n)中的上次测量结果固定在显示屏中。上次测得的表面温度通过标记(p)显示在结果刻度上(k)。

一旦测量值的偏差在3摄氏度以上，显示(j)中就出现测量过程的最小温度值和最大温度值。以此查看当前的测量值比已测得的温度高多少。

### 热桥模式

测量仪可以帮助您找到热桥(参见“热桥”，页 27)。

在开始测量前，必须首先调整外部温度。为此，请调出**<主菜单>** (参见“在<主菜单>中导航”，页 25)。选择子菜单**<热桥>**，调整当前的外部温度。通过按压测量按键(4)启动测量。

根据内部环境温度和外部温度计算表面温度是否满足热保护的最低要求。如果低于最低要求，则认为存在结构性缺陷并出现热桥警告。

完成测量后，显示中上一测量物体的表面温度(n)和显示中的环境温度(h)固定。计算的 $f_{RSI}$ 值(参见“热桥”，页 27)及其估算偏差显示在显示(v)中。

测量仪通过结果刻度(k)上的标记(p)显示数值说明：

- 标记(p)在绿色区域内 ( $f_{RSI}$ 值在0.7以上，包括公差)：不存在热桥
- 标记(p)在黄色区域内 ( $f_{RSI}$ 值在0.7的极限范围内)：测量范围内可能存在热桥。应在更有利的环境条件下（比如外部温度更低时）重复测量。
- 标记(p)在红色区域内 ( $f_{RSI}$ 值低于0.7，包括公差)：测量范围内很可能存在热桥。

### 露点模式

本测量仪可以帮助您找到有发霉危险的区域。

根据该模式中测得的环境温度和空气相对湿度(参见“空气相对湿度”，页 27)计算露点温度(参见“露点温度”，页 27)。将露点温度与测得的表面温度进行比较，并对发霉风险进行说明。

请注意，测量结果始终仅显示基于当前环境条件的说明。无法预测可能变化的环境条件。对于关键的

测量结果，应在不同的时间和不同的条件下重复测量。

通过按压测量按键(4)启动测量。显示屏中显示的测量值持续更新。

完成测量后，显示中上一测量物体的表面温度(n)、显示中的环境温度(h)和显示中的空气相对湿度(g)固定。在(i)中显示计算出的露点温度。

测量仪自动通过结果刻度(k)上的标记(p)来显示数值说明：

- 标记(p)在绿色区域内：在当前条件下不存在发霉风险。
- 标记(p)在黄色区域内：数值在极限范围内；请注意室温、热桥以及空气湿度。必要时，请隔一段时间重复测量。
- 标记(p)在红色区域内：由于空气湿度过高或表面温度接近露点温度，发霉风险增大。显示中相应的异常值闪烁。

当表面温度达到露点温度的80 %时，出现发霉风险警告。

**提示：**无法用本测量仪检测到霉菌孢子。该仪器仅显示当条件不变时可能会发霉。

#### 接触温度模式

测量接触温度时，可以借助常用的铠装K型热电偶直接测量某一物体的温度。

接触温度测量可以是非接触温度测量的有力补充。该应用在红外测量受原理限制有弊端的情况下特别有用，比如介质、液体、气流中或低辐射率表面（裸露金属）上的温度测量。

针对液体、气流中或表面上的各种应用，对传感器几何形状进行了专门优化，使用合适的传感器可以确保正确测量。

请阅读并遵守热电偶制造商的所有说明。

受原理限制，使用热电偶时需要直接接触测量物体。请注意潜在的危险和安全规章。

在该模式下仅测量温度传感器的温度，不包括其他测量变量。

**提示：**仅使用铠装K型热电偶。如果连接其他类型的热电偶，则测量结果可能错误。

打开盖子(1)，将热电偶连接到接口(25)上。

一旦连接上热电偶，显示屏中就出现显示(n)。显示的测量值持续更新。执行测量时，无需在该模式中按住测量按键(4)，激光器已停用。等待可靠的结果，直至测量值不再变化。视热电偶的规格而定，可能会持续几分钟。

除了表面温度外，在各个模式下还可以测量接触温度。然后，显示另一位置上的测量值(s)。确定热桥和发霉风险时，要始终考虑到表面温度(n)。

移除热电偶后，显示屏中的功能显示(s)熄灭。移除热电偶后，再次关上盖子(1)。

#### 用户模式

在用户模式下测量表面和环境温度以及空气相对湿度。根据这些值计算露点温度和平均温度（测量期间表面温度的平均值）。

必要时，可以隐藏显示中的以下数值：平均温度、空气相对湿度、环境温度和露点温度。

为此，请调出<主菜单>（参见“在<主菜单>中导航”，页 25）。选择子菜单<用户模式>。您可以在此处显示和隐藏显示内容<平均温度>、<空气湿度>、<室温>和<露点>。

对于表面温度测量，您可以选择是自动匹配结果刻度(k)的最小值和最大值(j)，还是手动设定。为此，通过菜单<用户模式>进入子菜单<刻度范围>。

- 当需要像在表面温度模式中那样自动确定数值(j)时，请选择<自动>。一旦测量值的偏差在3摄氏度以上，显示(j)中就出现测量过程的最小温度值和最大温度值。
- 选择<已预设>，以手动确定数值。在菜单<用户模式>中的<刻度下限>和<刻度上限>下调整所需的数值。显示(j)中出现手动设置的最小值和最大值。因此，可以借助标记(p)对比不同测量的屏幕截图。

#### 表面温度警告

除了接触温度测量外，表面温度警告可用于所有模式。您可以确定最低温度和最高温度。

如果低于**最低温度**，则温度警告指示灯(m)闪蓝光并在信号音接通时响起一声警告信号。

如果超过**最高温度**，则温度警告指示灯(m)闪红光并在信号音接通时响起一声警告信号。

如要使用表面温度警告，请调出<主菜单>（参见“在<主菜单>中导航”，页 25）。

- 选择子菜单<警报>。
- 将<最低/最高温度警报>调到<打开>。
- 在<最低温度警报>下设置最低温度。
- 在<最高温度警报>下设置最高温度。

将警告调整到<关闭>时，也会保存最低和最高温度。

#### 数据传输

##### 保存/显示/发送测量结果

完成一次测量后，显示屏中会出现一个保存图标，表示您可以保存测量结果。为此，按下保存/发送按键(9)。

测量结果保存为JPG文件（固定显示屏上的屏幕截图）。



- 如要**显示**保存的屏幕截图，请按压图片集图标(q)下的左侧功能键(17)。显示屏中显示上次保存的图片。

- 按压右侧箭头键(11)或左侧箭头键(15)，以便在保存的屏幕截图间来回切换。

- 如要通过**蓝牙®**发送显示的测量结果，请按压保存/发送按键(9)。如果**蓝牙®**连接尚未接通（参见“通过**蓝牙®**传输数据”，页 25），则请按压保存/发送按键激活。



- 如要**删除**显示的屏幕截图，请按压垃圾桶图标下方的右侧功能键(10)。



- 如要**确认**删除过程，请按压打叉图标下的左侧功能键(17)。





- 如要取消删除过程，请按压打叉图标下的右侧功能键(10)。



- 如要离开图片集视图和返回测量模式，请按压返回图标下的左侧功能键(17)。

您也可以一次性删除保存的所有文件(参见“<删除所有图像>”，页 26)。

### 通过USB接口传输数据

打开Micro-USB插口的盖子(1)。将测量仪的Micro-USB插口(26)通过随附的Micro-USB线(8)与您的计算机连接在一起。

现在通过电源开关(12)接通测量仪。

在您的计算机上打开文件浏览器并选择驱动器

**GIS 1000 C**。从测量仪内部存储器可复制已存的文件，将其移动到您的计算机上或删除。

一旦所需的过程结束后，请按标准流程将驱动器从计算机上脱开，然后通过电源开关(12)再次关闭测量仪。

**注意：**请始终先从您的操作系统上移除驱动器（弹出驱动器），否则可能会损坏测量仪的内部存储器。

在测量运行期间请移除Micro-USB线，并合上盖板(1)。

请始终保持USB接口盖板关闭，以免灰尘或溅水进入壳体内。

**提示：**仅可通过USB线将测量仪连接到计算机上。如果连接其他设备，则可能损坏测量仪。

### 通过蓝牙®传输数据

本测量仪装备有一个蓝牙®模块，可以将数据从测量仪无线传输到移动终端设备上。提供专用的博世应用程序（APP）供使用。这些应用程序可以根据终端设备在相应的软件商店中下载。



博世应用程序（除了无线传输数据外）还可以为您扩展功能范围和简化测量数据的再处理及转发（例如通过电子邮件）。关于建立蓝牙®连接所需的系统前提条件的信息，可在博世网站上找到：  
[www.bosch-professional.com/thermal](http://www.bosch-professional.com/thermal)。

如要接通测量仪上的蓝牙®连接，请调用<主菜单>（参见“在<主菜单>中导航”，页 25）并将<蓝牙>调到<打开>。在显示中出现显示(e)。请确保移动终端设备上的蓝牙®接口已激活。

启动博世应用程序后（在蓝牙®模块已激活的情况下），在移动终端设备和测量仪之间建立连接。如果找到多个激活的测量仪，请选择合适的测量仪。如果只找到一个激活的测量仪，则自动建立连接。

**提示：**在测量仪和移动终端设备（比如智能手机、平板）之间首次建立连接（配对）时，可能需要测量仪的PIN码。在这种情况下，请输入“0000”。借助蓝牙®传输数据时，移动终端设备与测量仪之间可能因接收条件不佳而出现时间延迟。

## <主菜单>

### 在<主菜单>中导航



- 如要进入<主菜单>，请按压标准显示屏上菜单图标(1)下的右侧功能键(10)。

- 如要在某一菜单级别中导航，请多次按压向上箭头键(16)或向下箭头键(13)，直至所需的菜单项用彩色突出显示。



- 如果突出显示的菜单项有子菜单，则用一个向右的箭头在<设置>旁进行标记。如要进入子菜单，请按压右侧箭头键(11)。



- 如果突出显示的菜单项有多个选项，则在2个箭头间显示当前设置。如要更改设置，请按压左侧箭头键(15)或右侧箭头键(11)。如果按住相应的箭头键，数值变化速度更快。

- 对于某些菜单项，可以接通或关闭功能。如要关闭，请按压左侧箭头键(15)，使<关闭>突出显示。如要接通，请按压右侧箭头键(11)，使<打开>突出显示。您也可以在菜单中通过按压保存/发送按键(9)接通和关闭该功能。



- 如要切换到上级菜单，请按压返回图标下的左侧功能键(17)。保存选择的设置。



- 如要离开<主菜单>和直接返回到标准显示屏，请按压房屋图标下的右侧功能键(10)。保存选择的设置。



- 如要退出任一菜单并返回标准显示屏，您也可按压测量按键(4)。按压一次该按键可保存所选的设置，但不会触发任何测量。

## 测量子菜单

### <辐射率> (t)

对于若干最常见材料，有已存储的辐射率可供选择。为了简化搜索，这些值在辐射率目录中进了分组。首先在菜单项<材料>下选择合适的类别，然后选择合适的材料。相应辐射率显示在下面一行中。如果您已知测量物体的确切辐射率，也可在菜单项<辐射率>中以数值形式设置该辐射率。

如果经常测量相同的材料，则可以收藏5个辐射率，以便通过顶部栏（从1至5编号）快速调用。

### <反射温度> (t)

这个参数的设置可以改善测量结果，特别是对于辐射率较低（=高反射）的材料。在某些情况下（尤其是在室内），反射温度就是环境温度。如果反射强

烈的物体附近有温差较大的物体会影响测量，那么应调整该数值。

#### 子菜单<设备>

请调用<主菜单>并选择子菜单<设备>。包括以下菜单项。

#### <语言>

在菜单<语言>中可以更改所有显示的语言。

#### <时间/日期>

如要更改显示(a)中的日期和时间，请调出子菜单<时间/日期>。此外，在该子菜单中还可更改时间和日期格式。

如要离开子菜单<时间/日期>，请按压左侧功能键(17)以保存设置或按压右侧功能键(10)以放弃改动。

#### <单位>

在菜单<单位>中可以选择不以<°C>还是以<°F>为单位显示温度值。

#### <激光>

在菜单<激光>中可以接通或关闭测量仪的激光器。激光器用于限制测量面，因此仅可在例外情况下停用。

#### <测量框>

在菜单<测量框>中可以接通或关闭显示屏中的测量框架(b)。

#### <颜色方案>

在菜单<颜色方案>中可以选择不以哪种颜色显示显示屏中的温度值和其他数据。该设置也应用于已保存的屏幕截图。

#### <关闭时间>

在菜单<关闭时间>中可以选择不按压按键时测量仪自动关闭的时间周期。选择设置<切勿>，您也能停用自动关闭。关闭时间设置得越短，越节能。

#### <照明时长>

在菜单<照明时长>中可以选择不按压测量仪上的按键时显示屏亮度减弱的时间周期。也可以通过选择设置<始终>持续照亮显示屏。照明时长设置得越短，越节能。

#### <信号音>

可以在表面温度警告响起时通过菜单<信号音>接通或关闭信号音。

#### <删除所有图像>

可以在菜单<删除所有图像>中一次性删除内部存储器中的所有文件。按压<更多>的右侧箭头键(11)，以便进入子菜单。然后按压右侧功能键(10)以删除所有文件或按压左侧功能键(17)以取消该过程。

#### <设备信息>

如要了解测量仪的信息，请调出子菜单<设备信息>。您在这里可找到测量仪的序列号和安装的软件版本。

#### <出厂设置>

可以通过该菜单项将测量仪恢复到出厂设置以及彻底删除所有数据。这可能需要几分钟。按压<更多>的右侧箭头键(11)，以便进入子菜单。然后按压右侧功能键(10)以删除所有文件或按压左侧功能键(17)以取消该过程。

## 故障 - 原因和补救措施

故障	原因	解决措施
	测量仪无法接通。 充电电池或蓄电池电量耗尽	为充电电池充电或更换蓄电池。
	充电电池过热或过冷	使充电电池冷却或更换充电电池。
	图像存储器故障	通过删除所有图像来格式化内部存储器(参见“<删除所有图像>”，页 26)。如果问题仍存在，请将测量仪发送给经授权的博世客户服务中心。
	图像存储器已满	必要时，请将图像传输至另一存储介质(比如计算机或笔记本电脑)。然后删除内部存储器中的图像。
	测量仪损坏	将测量仪发送给经授权的博世客户服务中心。
	显示屏中未出现有关接触温度测量的功能显示(s)。	检查热电偶的功能，将测量仪发送给经授权的博世客户服务中心。
	测量仪无法与计算机连接在一起。	检查计算机上的驱动程序是否是最新版本。计算机上可能需要更新版本的操作系统。
	Micro-USB接口或Micro-USB线故障	检查测量仪是否与其他计算机连接在一起。如果未连接在一起，请将测量仪发送给经授权的博世客户服务中心。
	空气湿度和环境温度传感器(5)故障	测量仪的其他功能可以继续使用。将测量仪发送给经授权的博世客户服务中心。

## 术语解释

### 红外热辐射

红外热辐射是每个0开氏度（-273 °C）以上的物体都会发出的电磁辐射。辐射量取决于物体的温度和辐射率。

### 辐射率

物体辐射率取决于其表面的材质和结构。它表示，与理想的热辐射器（黑色物体，辐射率 $\epsilon = 1$ ）相比，该物体发出的红外热辐射量，数值在0至1之间。

### 反射温度/物体反射性

反射温度是并非由物体自身发出的热辐射。视结构和材料而定，环境辐射在待测物体上反射，从而使原本的温度结果失真。

### 热桥

热桥是建筑物外墙上的一个部位，在该部位上因结构会导致局部热量损失增加。

为了能够评估热桥，可以使用DIN 4108-2中所述的最低热保护要求。

根据DIN 4108-2，如果温度系数 $f_{Rsi}$ 大于**0.7**，则满足最低热保护要求。

温度系数 $f_{Rsi}$ 的计算方法如下：

$$f_{Rsi} = \frac{T_1 - T_2}{T_3 - T_2}$$

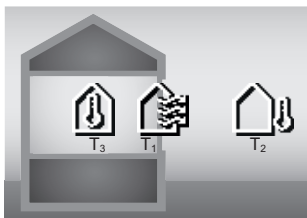

$T_1$ ：内部表面温度  
 $T_2$ ：外部温度  
 $T_3$ ：内部环境温度

最低热保护功能用于避免在标准边界条件下发霉，从而避免危害建筑材料。

在标准条件（外部温度-5摄氏度，内部环境温度20摄氏度）下，表面温度不应降到12.6摄氏度以下。对应于 $f_{Rsi}$ 极限值0.7。为了获得最有效的结果（不确定性系数小），外部温度低于10摄氏度。

### 空气相对湿度

空气相对湿度可以说明空气中水蒸气的饱和程度。该数值以百分比的形式给出空气可吸收的最大水蒸汽量。最大水蒸汽量取决于温度：温度越高，空气可吸收的水蒸汽越多。

如果空气相对湿度过高，则发霉风险增大。湿度过低可能会危害健康。

### 露点温度

露点温度是空气中包含的水蒸汽开始冷凝的温度。露点温度取决于空气相对湿度和空气温度。

如果表面温度低于露点温度，则水开始在该表面上凝结。

表面上的冷凝水是发霉的主要原因。

## 维修和服务

### 维修和清洁

测量仪器必须随时保持清洁。脏污的红外接收镜头**(23)**可能会影响测量精度。

使用干燥、柔软的布擦除仪器上的污垢。切勿使用任何清洁剂或溶剂。

清洁时不允许有液体渗入测量仪中。

空气湿度和温度传感器**(5)**、摄像头**(22)**、接收镜头**(23)**、灯**(24)**和激光发射口**(2)**要特别小心地清洁：注意，请勿在摄像头、接收镜头或激光发射口上留下绒毛。只能使用适合于照相机镜头的清洁剂清洁摄像头、接收镜头和激光发射口。请勿尝试用尖头物去除传感器中、摄像头或接收镜头上的脏污，或在摄像头和接收镜头上面来回擦拭（可能导致划伤）。

请勿将测量仪长时间存放在空气湿度在30%至50%的环境中。如果测量仪存放的环境过湿或过干，则可能在投入使用时出现错误测量。

受原理限制，空气湿度传感器对溶剂、粘合剂和增塑剂比较灵敏。这些物质的持续性影响可能会导致测得的空气湿度出现偏差。

请勿将测量仪存放在蒸汽可能会损坏空气湿度和温度传感器**(5)**的塑料袋中。在测量仪上传感器周围不可粘贴任何标签。

如果需要重新校准测量仪，请联系经授权的博世客户服务中心。

使用附带的保护套储存和携带仪器。

需要修理时，请将测量仪装入保护袋邮寄。

### 客户服务和应用咨询

本公司客户服务处负责回答有关本公司产品的修理、维护和备件的问题。备件的展开图纸和信息也可查看：[www.bosch-pt.com](http://www.bosch-pt.com)

博世应用咨询团队乐于就我们的产品及其附件问题提供帮助。

询问和订购备件时，务必提供机器铭牌上标示的10位数物品代码。

### 中国大陆

博世电动工具（中国）有限公司

中国 浙江省 杭州市

滨江区 滨康路567号

102/1F 服务中心

邮政编码：310052

电话：(0571)8887 5566 / 5588

传真：(0571)8887 6688 x 5566# / 5588#

电邮：[bsc.hz@cn.bosch.com](mailto:bsc.hz@cn.bosch.com)

[www.bosch-pt.com.cn](http://www.bosch-pt.com.cn)

### 制造商地址：

Robert Bosch Power Tools GmbH

罗伯特·博世电动工具有限公司

70538 Stuttgart / GERMANY

70538 斯图加特 / 德国

### 其他服务地址请见：

[www.bosch-pt.com/serviceaddresses](http://www.bosch-pt.com/serviceaddresses)

## 搬运

随着机器一起供货的锂离子电池充电电池必须符合危险物品法规。使用者无须另外使用保护包装便可以运送该充电电池。

但是如果将它交由第三者运送（例如：寄空运或委托运输公司）则要使用特殊的包装和标示。此时必须向危险物品专家请教有关寄送危险物品的相关事宜。

确定充电电池的外壳未受损后，才可以寄送充电电池。粘好未加盖的触点并包装好充电电池，不可以让充电电池在包装中晃动。必要时也得注意各国有关的法规。

## 处理废弃物



应对测量仪、蓄电池/电池、附件和包装进行环保的回收利用。



请勿将测量仪和电池/蓄电池扔到生活垃圾里！

### 仅适用于欧盟国家：

无法再使用的测量仪根据欧盟第2012/19/EU号指令，损坏的或旧充电电池/蓄电池根据欧盟第2006/66/EC号指令必须单独收集并根据环保要求进行回收利用。

### 蓄电池/电池：

#### 锂离子：

请注意搬运段落中的指示。（参见“搬运”，页 28）。

## 有关中国的更多信息

CMIIT ID显示在蓝牙设备铭牌上

# 繁體中文

## 安全注意事項



為確保能夠安全地使用本測量工具，您必須完整詳讀本說明書並確實遵照其內容。若未依照現有之說明內容使用測量工具，測量工具內部所設置的防護措施可能無法發揮應有功效。謹慎對待測量工具上的警告標示，絕對不可讓它模糊不清而無法辨識。請妥善保存說明書，將測量工具轉交給他人時應一併附上本說明書。

- ▶ **小心** - 若是使用非此處指明的操作設備或校正設備，或是未遵照說明的操作方式，可能使您暴露於危險的雷射光照射環境之下。
- ▶ 本測量工具出貨時皆有附掛雷射警示牌（即測量工具詳解圖中的標示處）。
- ▶ 雷射警示牌上的內容若不是以貴國語言書寫，則請於第一次使用前將隨附的當地語言說明貼紙貼覆於其上。



請勿將雷射光束對準人員或動物，您本人亦不可直視雷射光束或使雷射光束反射。因為這樣做可能會對他人眼睛產生眩光，進而引發意外事故或使眼睛受到傷害。

- ▶ 萬一雷射光不小心掃向眼睛，應立刻閉上眼睛並立刻將頭轉離光束範圍。
- ▶ 請勿對本雷射裝備進行任何改造。
- ▶ 請勿將雷射眼鏡當作護目鏡（配件）使用。雷射眼鏡是用來讓您看清楚雷射光束；但它對於雷射光照射並沒有保護作用。
- ▶ 請勿將雷射眼鏡當作護目鏡（配件）使用，或在道路上行進間使用。雷射眼鏡無法完全阻隔紫外線，而且還會降低您對於色差的感知能力。
- ▶ 本測量工具僅可交由合格的專業技師以原廠替換零件進行維修。如此才能夠確保本測量工具的安全性能。
- ▶ 不可放任兒童在無人監督之下使用本雷射測量工具。他們可能會不小心對他人或自己的眼睛造生眩光。
- ▶ 請不要在存有易燃液體、氣體或粉塵等易爆環境下操作本測量工具。測量工具內部產生的火花會點燃粉塵或氣體。
- ▶ 切勿拆開充電電池。可能造成短路。
- ▶ 如果充電電池損壞了，或者未按照規定使用充電電池，充電電池中會散發出有毒蒸氣。充電電池可能起火或爆炸。工作場所必須保持空氣流通，如果身體有任何不適必須馬上就醫。充電電池散發的蒸氣會刺激呼吸道。
- ▶ 不當使用或充電電池受損時，充電電池可能會流出可燃液體。請避免接觸。意外沾到時，請用水徹底沖洗。如果液體跑進眼睛裡，請進一步就醫。從電池中滲出的液體可能造成腐蝕或起火。
- ▶ 尖銳物品（例如釘子或螺絲起子）或是外力皆有可能造成充電電池損壞。進而導致內部短路而發生電池起火、冒煙、爆炸或過熱等事故。
- ▶ 充電電池不使用時，請讓它遠離迴紋針、硬幣、鑰匙、釘子、螺釘或其他小金屬物體，以免造成兩極相接。電池端點短路會引起燃燒或火災。
- ▶ 僅可使用產品的原廠充電電池。如此才可依照產品提供過載保護。
- ▶ 僅能使用製造商規定的充電器進行充電。將適用於某特定電池盒的充電器用於其他電池盒時，可能會造成起火燃燒。



保護充電電池免受高溫（例如長期日照）、火焰、污垢、水液和濕氣的侵害。有爆炸及短路之虞。



- ▶ 在測量工具上進行任何作業（例如安裝、保養等等）以及搬運、收納測量工具之前，必須先將充電電池或一般電池從測量工具中取出。若是小心觸動起停開關，可能造成人員受傷。
- ▶ **小心！** 使用測量工具時若開啟藍牙®（藍牙）功能，將可能對其他裝置或設備、飛機以及醫療器材（例如心律調節器、助聽器等）產生干擾。同樣亦無法完全排除對鄰近之人員或動物造成身體

危害的可能性。請勿在醫療器材、加油站、化學設備、爆炸危險場所以及易爆環境等處附近，使用測量工具的藍牙®功能。請勿在飛機上使用測量工具的藍牙®功能。應避免直接貼靠在身體部位旁長時間持續操作。

Bluetooth® 一詞及其標誌（商標）為 Bluetooth SIG, Inc. 所擁有之註冊商標。Robert Bosch Power Tools GmbH 對於此詞彙／標誌之任何使用均已取得授權。

- ▶ 請保護測量工具，特別是空氣濕度、環境溫度和紅外線感應器，避免沾染上濕氣、雪、灰塵和髒污。接收鏡頭可能會起霧或髒污，造成測量結果錯誤。裝置若設定錯誤，或是受到其他天候因素的影響，皆可能導致測量發生錯誤。所顯示的物體溫度可能極高或極低，因此碰觸時可能發生危險。
- ▶ 唯有所設定的發射率與物件的發射率一致，且設定正確的反射溫度時，才能正確測量溫度。所顯示的物體溫度可能極高或極低，因此碰觸時可能發生危險。

### 使用熱耦線的安全注意事項

- ▶ 熱耦線不得在帶電裝置內使用。可能有生命之虞！
- ▶ 透過使用熱耦線會與測量標的物產生接觸。因此，請注意溫度、電壓或化學反應可能產生的潛在危險。

## 產品和功率描述

請留意操作說明書中最前面的圖示。

### 依規定使用機器

本測量工具適用於非接觸性的表面溫度、環境溫度和相對空氣濕度之測量作業。該工具會計算露點溫度，提醒可能有熱橋效應和發霉的風險。使用本測量工具無法測得黴菌孢子，但有助於提早偵測到有助於黴菌生長的條件。

本測量工具不得用於測量人體或動物的體溫或做為其他醫療用途。

本測量工具不適用於測量氣體的表面溫度。

液體的溫度測量僅能使用市售熱耦線（連接類型 K）進行，其可透過指定的連接介面（25）連接在本測量工具上。

使用熱耦線，透過觸摸表面也可進行表面溫度測量。

本測量工具的照明裝置是用來於拍攝時為測量工具的直接工作範圍提供照明。

雷射點不得用來作為雷射筆。其僅能用來選取測量面。

本測量工具可同時適用於室內及戶外應用。

### 插圖上的機件





機件的編號和儀器詳解圖上的編號一致。

- (1) Micro-USB 插孔／熱耦線連接頭（類型 K）護蓋

- (2) 雷射光束射出口
- (3) 充電電池／電池轉接器／電池盒蓋解鎖按鈕
- (4) 測量按鈕／啟動按鈕
- (5) 空氣濕度和環境溫度感應器
- (6) 序號
- (7) 雷射警示牌
- (8) Micro-USB 傳輸線
- (9) 儲存按鈕／發送按鈕（藍牙®）
- (10) 右側功能按鈕
- (11) 右側箭頭按鈕
- (12) 電源按鈕
- (13) 往下箭頭按鈕／降低放大級數
- (14) 電源按鈕指示燈
- (15) 左側箭頭按鈕
- (16) 往上箭頭按鈕／增加放大級數
- (17) 左側功能按鈕
- (18) 顯示器
- (19) 空氣濕度和環境溫度感應器防護罩
- (20) 腕帶繫座
- (21) 紅外線接收鏡頭防護罩
- (22) 攝影機
- (23) 紅外線輻射接收點
- (24) 照明裝置
- (25) 類型 K 熱耦線連接頭
- (26) Micro-USB 插孔
- (27) 電池轉接匣<sup>a)</sup>
- (28) 電池轉接器的密封端蓋<sup>a)</sup>
- (29) 電池盒
- (30) 充電電池<sup>a)</sup>
- (31) 電池盒蓋<sup>a)</sup>

a) 圖表或說明上提到的配件，並不包含在基本的供貨範圍中。本公司的配件清單中有完整的配件供應項目。

### 顯示元件（請參考圖 A）

- (a) 日期／時間（參見「<時間與日期>」，頁 36）
- (b) 測量框（參見「表面溫度測量時的測量面」，頁 33）
- (c) 狀態指示燈：
  -  測量工具已達測量就緒狀態，請按下測量按鈕 (4)。
  -  （持續性）測量運行中，雷射器已啟動。
  -  測量結束，雷射器已關閉，測量結果已確定。
  -  接觸溫度模式，雷射器已關閉，測量僅透過熱耦線運行。
- (d) 顯示放大級數（參見「設定放大級數」，頁 33）

### 30 | 繁體中文

- (e) 藍牙® 指示燈已啟動 (參見「透過藍牙® 功能傳輸資料」, 頁 35)
- (f) 充電電量指示燈
- (g) 功能指示燈 / 相對空氣濕度測量值
- (h) 功能指示燈 / 環境溫度測量值
- (i) 功能指示燈 / 露點溫度結果
- (j) 測量程序期間表面溫度的最小 / 最大測量值
- (k) 結果量表
- (l) 選單符號
- (m) 表面溫度警報指示燈 (參見「表面溫度警報」, 頁 34)
- (n) 測量值
- (o) 目前模式
- (p) 測量值或結果標示 (視所選模式而定)
- (q) 圖庫符號
- (r) 功能指示燈 / 平均溫度測量值
- (s) 功能指示燈 / 接觸溫度測量值
- (t) 發射率 / 反射溫度指示燈
- (u) 所設定的外側溫度 (熱橋模式)
- (v) 顯示  $f_{Rsi}$  值含公差 (熱橋模式)

### 技術性數據

熱影像攝影機	GIS 1000 C	GIS 1000 C
產品機號	<b>3 601 K83 3..</b>	<b>3 601 K83 371</b>
工作範圍	0.1–5 m	0.1–5 m
測量範圍		
– 表面溫度	–40 至 +1000 °C	–40 至 +1000 °C
– 接觸溫度	–40 至 +1000 °C	–40 至 +1000 °C
– 環境溫度	–10 至 +50 °C	–10 至 +50 °C
– 相對空氣濕度	0 至 100 %	0 至 100 %
測量準確度 <sup>A)</sup>		
表面溫度 <sup>B)</sup>		
–40 至 –20.1 °C	±2.5 °C	±2.5 °C
–20 至 –0.1 °C	±1.5 °C	±1.5 °C
<b>0 至 +100 °C</b>	<b>±1 °C</b>	<b>±1 °C</b>
+100 °C 至 +400 °C	±1 %	±1 %
> +400 °C	±2 %	±2 %
環境溫度	±1 °C	±1 °C
相對空氣濕度 <sup>C)</sup>		
< 20 %	±3 %	±3 %
<b>20 至 60 %</b>	<b>±2 %</b>	<b>±2 %</b>
60 至 90 %	±3 %	±3 %
光學規格 (測量距離與待測物體大小的比例) <sup>D)E)</sup>	50 : 1	50 : 1
雷射等級	2	2
雷射種類	635 nm, < 1 mW	635 nm, < 1 mW
擴散度 (全角度)	< 1.5 mrad	< 1.5 mrad
從基準點高度算起的最大可測量高度	2000 m	2000 m
依照 IEC 61010-1, 污染等級為	2 <sup>F)</sup>	2 <sup>F)</sup>
最大相對空氣濕度。	90 %	90 %
拋棄式電池 (鹼-錳)	4 × 1.5 V LR6 (AA) (使用電池轉接器)	4 × 1.5 V LR6 (AA)
充電電池 (鋰離子)	10.8 V / 12 V	–
連續工作時間		
– 拋棄式電池 (鹼-錳)	3 小時	3 小時
– 充電電池 (鋰離子) <sup>G)</sup>	10 小時	–

熱影像攝影機	GIS 1000 C	GIS 1000 C
內部圖片儲存記憶中的圖片數量	> 200	> 200
藍牙® (Classic and Low Energy)	4.2 <sup>H)</sup>	4.2 <sup>H)</sup>
工作頻率範圍	2402-2480 MHz	2402-2480 MHz
最大發射功率。	2.5 mW	2.5 mW
USB 連接埠	2.0	2.0
重量符合 EPTA-Procedure 01:2014 <sup>G)</sup>	0.56-0.77 kg	0.51 kg
尺寸 (長 x 寬 x 高)	136 x 89 x 214 mm	136 x 89 x 214 mm
環境條件		
- 充電狀態下的建議環境溫度	0°C 至 +35°C	-
- 運轉時的容許環境溫度	-10°C 至 +50°C	-10°C 至 +50°C
- 無充電電池的存放狀態下的容許環境溫度	-20°C 至 +70°C	-20°C 至 +70°C
- 有充電電池的存放狀態下的容許環境溫度	-20°C 至 +50°C	-
建議使用的充電電池	GBA 10,8V... GBA 12V...	-
建議使用的充電器	GAL 12...	-

A) 加上使用相關的偏差 (例如: 反射、距離、環境溫度)

B) 環境溫度從 +20 °C 至 +23 °C、發射率 > 0.999、測量距離 0.3 m、光圈 60 mm

C) 環境溫度從 +15 °C 至 +40 °C

D) 該項數據符合 VDI/VDE 3511 第 4.3 節 (2005 年 7 月發佈) ; 適用於 90 % 的測量訊號。  
此份技術性數據中除了尺寸相關資料外, 皆可能與實際測量結果有所差異。

E) 此項數值與紅外線測量有關, 請參考圖示:

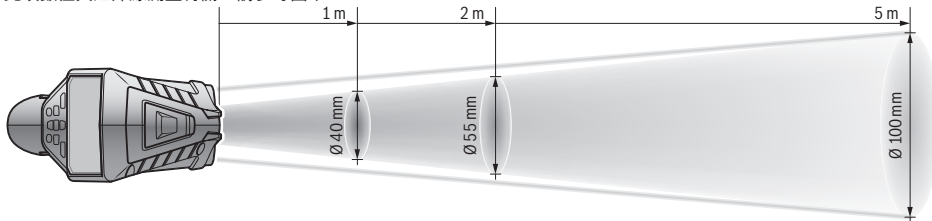

F) 只產生非傳導性污染, 但應預期偶爾因水氣凝結而導致暫時性導電。

G) 視所使用的充電蓄電池而定

H) 藍牙® Low-Energy 裝置視機型和作業系統而定, 可能無法建立連線。藍牙® 裝置必須支援 SPP 模式。  
從產品銘牌上的序號 (6) 即可識別您的測量工具。

## 安裝

### 測量工具的電源供應

本測量工具可以使用一般的電池也可以使用博世鋰離子充電電池。

產品機號 **3 601 K83 371**: 本測量工具僅可使用一般市售電池。

#### 使用電池運行 (不適用於產品機號

**3 601 K83 371) (請參考圖 B)**

一般電池先放入電池轉接器內。

- ▶ 電池轉接器僅能在指定的博世測量工具上使用, 不得搭配電動工具一起使用。

將電池轉接匣 (27) 推入電池盒 (29) 中, 即可裝入電池。根據密封端蓋上的圖示 (28), 將電池置入匣套裡。請推移密封端蓋, 讓她覆蓋在匣套上, 直到可感覺到已卡上。



若要 **取出** 電池, 請按壓密封端蓋 (28) 的解鎖按鈕 (3), 並將密封端蓋拔下。此時請注意: 不可讓電池掉出來。使測量工具的電池盒 (29) 保持朝上。取出電池。若要將內置的電池轉接匣 (27) 從電池盒中取出, 請將手伸進電池轉接匣內, 然後輕輕按壓側壁, 並同時將它從測量工具中拔出。務必同時更換所有的電池。請使用同一製造廠商, 容量相同的電池。

- ▶ **長時間不使用時, 請將測量工具裡的電池取出。** 電池可能因長時間存放於測量工具中不使用而自行放電。

#### 使用充電電池運行 (不適用於產品機號

**3 601 K83 371) (請參考圖 C)**

- ▶ **只能選用技術性數據裡所列出的充電器。** 僅有這些充電器適用於測量工具所使用的鋰離子充電電池。

**提示：**若是使用非本測量工具適用的充電電池，可能導致測量工具功能異常或損壞。

**提示：**出貨時充電電池已部分充電。首度使用之前，請先將充電電池充飽電，以確保充電電池的完整功率。

鋰離子充電電池可隨時充電，這樣做並不會縮短電池的使用壽命。如果突然中斷充電，電池也不會損壞。

若要裝入已充好電的充電電池 (30)，請將電池推入電池盒 (29)，直到感覺扣入，並齊平緊貼在測量工具把手上。

若要取出充電電池 (30)，請按壓解鎖按鈕 (3)，並將充電電池拔出電池盒 (29)。不可以強行拉出充電電池。

### 使用電池運行 (3 601 K83 371) (請參考圖 D)

若要打開電池盒蓋 (31)，請按壓解鎖按鈕 (3)，並取下電池盒蓋。

裝入電池時請注意，是否已依照電池盒蓋上的電極標示正確放入。

重新裝上電池盒蓋 (31)，直到感覺扣入。

務必同時更換所有的電池。請使用同一製造廠商，容量相同的電池。

- ▶ **長時間不使用時，請將測量工具裡的電池取出。**  
電池可能因長時間存放於測量工具中不使用而自行放電。

## 操作

### 操作機器

- ▶ **不可以讓濕氣滲入儀器中，也不可以讓陽光直接照射在儀器上。**
- ▶ **勿讓測量工具暴露於極端溫度或溫度劇烈變化的環境。**例如請勿將它長時間放在車內。測量工具歷經較大溫度起伏時，請先讓它回溫後再使用。如果儀器暴露在極端溫度下或溫差較大的環境中，會影響儀器的測量準確度。
- ▶ **請注意：須讓測量工具完全適應氣候。**溫度劇烈波動時，氣候調適時間可能會長達 60 分鐘。例如：若將測量工具放置在冰冷的車上，之後在溫暖的建築物中進行測量時，可能就會出現這種情況。
- ▶ **測量工具須避免猛力碰撞或翻倒。**測量工具遭受外力衝擊後，功能上若有任何異常，則應將它送交本公司授權的 Bosch 客戶服務中心進一步檢修。

### 啟動/關閉

將防護罩 (21) 從紅外線接收鏡頭 (23) 上取下，將防護罩 (19) 從空氣濕度和環境溫度感應器 (5) 上取下。**作業期間請注意，攝影機 (22)、接收鏡頭 (23) 和感應器 (5) 不可堵住或被遮住，否則無法正確進行測量。**

若要啟動測量工具，請按下電源按鈕 (12) 或測量按鈕 (4)。顯示器 (18) 上會顯示正在啟動。啟動程序完成後，測量工具即處於上一次關閉時儲存的操作模式下。雷射器尚未啟動。

僅於首次投入運行時，完成啟動程序後還會額外出現 <裝置> 選單，您可在該選單內進行例如：所有指示器的語言等測量工具設定 (參見「子選單 <裝置>」，頁 36)。按下右側功能按鈕 (10)，以確認所選設定。所有設定皆可後續在子選單 <裝置> 中變更。

- ▶ **不可放任啟動的測量工具無人看管，使用完畢後請關閉測量工具電源。**雷射可能會對旁人的眼睛產生眩光。
- ▶ **雷射光束不可以對準人或動物，操作人本身也不要直視光束，即使和光束相距甚遠也不可以做上述動作。**

螢幕照明的亮度在原廠設定時，基於節能因素每次按下按鈕後 30 秒鐘會降低。按下任一按鈕時，螢幕照明會重新啟動到最大強度。您可在選單 <全亮持續時間> 中變更照明時間 (參見「<全亮持續時間>」，頁 36)。

若要關閉測量工具，請按下電源按鈕 (12)。本測量工具會先儲存目前操作模式和設定，然後關機。將防護罩 (21) 重新套在接收鏡頭 (23) 上，將防護罩 (19) 套在空氣濕度和環境溫度感應器 (5) 上。請勿透過取下充電電池或電池轉接器的方式關閉測量工具，因為在不利的情況下可能會損壞內部記憶體。

您可在主選單中設定，是否在不按按鈕/測量的情況下以及多久時間後，測量工具即自動關機 (參見「<關機時間>」，頁 36)。但即使是自動關機，仍保留目前的操作模式和設定的儲存。

若充電電池或測量工具位於技術性數據中所指定的操作溫度之外，則測量工具會在短暫警示 (參見「故障 - 原因和補救方法」，頁 36) 後自動關機。讓測量工具的溫度回溫，然後再重新啟動一次。

### 測量事前準備

#### 設定表面溫度測量的發射率

表面溫度的判定並不需要接觸測量標的物，而是直接估量該物自然發散的紅外線熱輻射。為確保正確進行測量，**每次測量前**都必須檢查測量工具上所設定的發射率，必要時請配合測量標的物進行調整。測量工具內預設的發射率為參考值。

您可以從發射率預設值中挑選，或者直接輸入一個準確的數值。請透過選單 <測量> → <發射率> 設定所需的發射率 (參見「<主功能表>」，頁 35)。

- ▶ **唯有所設定的發射率與物件的發射率一致，且設定正確的反射溫度時，才能正確測量溫度。**所顯示的物體溫度可能極高或極低，因此碰觸時可能發生危險。

發射率越低，反射溫度對測量結果的影響越大。所以變更發射率時，請務必調整反射溫度。請透過選單 <測量> → <反射溫度> 設定反射溫度 (參見「<主功能表>」，頁 35)。

若有數個發射率不同的測量標的物位於由雷射器選取的測量面內，溫度測量可能會錯誤。



### 表面溫度測量時的測量面

測量工具產生的雷射點會限制出外部的圓形測量面。所示的溫度測量值代表該面範圍內的平均表面溫度。

▶ **雷射光束不可以對準人或動物，操作人本身也不要直視光束，即使和光束相距甚遠也不可以做上述動作。**

雷射點的距離和測量面的尺寸會隨著測量工具和測量標的物之間的距離拉開而變大。

若雷射點難以辨識，可開啟顯示器上的 **<測量框>** (b) (參見「**<測量框>**」，頁 36)。測量框可用來作為測量面的指示器，有助於定向。視測量距離而定，測量框可能會與測量面有落差。雷射點之間的區域對測量作業非常重要。

### 測量條件的相關注意事項

反射率高、亮面或透明的表面 (例如：亮面瓷磚、不鏽鋼面板或鍋具) 可能會干擾表面溫度測量。您可視需要用導熱佳的深色非亮面膠帶貼住測量區塊。然後讓膠帶先閒置一段時間，使它與底下的表面達到均溫。

由於原理的緣故，無法穿透透明材料進行測量。

測量條件愈佳、愈穩定，其測量結果也就更準確、可信度更高。

空氣濕度和環境溫度感應器 (5) 可能會因例如：烤漆和顏料的蒸發等化學有害物質而受損。煙霧、蒸汽或混濁的空氣皆會干擾紅外線溫度測量。

因此，在室內進行測量之前，請先通風，尤其是在空氣髒污或充滿蒸汽的情況下。舉例來說，請勿在淋浴後馬上測量浴室。

通風後，請稍待片刻讓室內回溫至正常溫度。

環境溫度和相對空氣濕度會直接在測量工具上的空氣濕度和環境溫度感應器 (5) 上進行測量。為確保測量結果具說服力，測量工具請勿直接置於暖氣或開放性液體等干擾源上方或旁邊。切勿遮蓋住感應器 (5)。

請注意：如果是會反射的表面，則必須調整至最佳測量角度，不要因為從其他測量標的物反射過來的熱輻射造成測量結果產生誤差。例如：進行前方垂直測量時，您自身的體溫反射可能就會干擾到測量。

### 設定放大級數

進行測量以及播放儲存的螢幕畫面時，顯示器上的局部畫面可顯示 3 種不同的放大級數：0.5 m、2 m 和 5 m。

放大級數已針對測量工具和測量標的物之間的相應距離優化：測量距離為 2 m 時，放大級數「**2 m**」能重現 (典型) 最佳局部畫面。

目前的放大級數會顯示在指示器 (d) 上。若要增加放大級數，請按下增加放大級數箭頭按鈕 (16)，若要降低，則按下降低放大級數箭頭按鈕 (13)。

因視差的因素，所選放大級數為實際測量距離時，測量框 (b) 僅與測量範圍互相一致。

### 照明測量面

在黑暗的区域進行測量時，可啟動照明裝置 (24)，提升螢幕內容的顯示品質。這有助於在儲存螢幕畫面時，可取得較佳的結果。

按下按鈕 (14) 以啟動或關閉照明裝置 (24)。

基於節能因素，顯示器照明亮度降低時，該照明裝置會自動關閉。可在選單 **<全亮持續時間>** 中變更照明時間 (參見「**<全亮持續時間>**」，頁 36)。重新啟動顯示器照明時，該照明裝置不會自動啟動。充電電池的電力不足時，基於節能因素無法使用照明裝置。

### 測量功能

#### 在個別模式之間切換

按下右側 (11) 或左側 (15) 箭頭按鈕選擇所需模式 (系統會以簡短說明顯示模式)。若要提早隱藏說明，請按下儲存按鈕 (9)。若要隱藏說明，立刻啟動測量，請按下測量按鈕 (4)。

#### 表面溫度模式

在表面溫度模式下，可進行測量標的物表面溫度的測量。

在此模式下，例如：可檢查暖氣或搜尋過熱的裝置部件。

按下測量按鈕 (4)，即可開始進行測量。顯示器上所顯示的測量值會持續更新。一放開測量按鈕 (4)，隨即中斷測量，雷射器便會關閉。顯示器上的指示器 (n) 中即為最後確認的測量結果。上一次測得的表面溫度會以標示 (p) 顯示在結果量表 (k) 上。

測量值的差異一旦大於 3 °C，測量程序的最小和最大溫度值會顯示在指示器 (j) 中。即可看出，目前測量值高出之前測得溫度的程度。

#### 熱橋模式

本測量工具可用於尋找熱橋效應 (參見「熱橋效應」，頁 37)。

在開始進行測量前，必須先設定外側溫度。此時，請先開啟 (參見「在 **<主功能表>** 中瀏覽」，頁 35) 上的 **<主功能表>**。選擇子選單 **<熱橋現象>**，然後設定目前的外側溫度。按下測量按鈕 (4)，即可開始進行測量。

在考量內部環境溫度和外側溫度的情況下，即可測定表面溫度是否符合隔熱保護的最低要求。若低於最低要求，系統會認定有結構性瑕疵，並發出熱橋效應警示。

結束測量後，最後一個測量標的物的表面溫度便會確認顯示在指示器 (n) 中，環境溫度則確認顯示在指示器 (h) 中。所計算出的  $f_{RSI}$  值 (參見「熱橋效應」，頁 37) 和其預估誤差會顯示在指示器 (v) 中。

測量工具會將該值的詮釋以標示 (p) 顯示在結果量表 (k) 上：

- 標示 (p) 在綠色範圍內 ( $f_{RSI}$  值超過 0.7，含誤差)：無熱橋效應
- 標示 (p) 在黃色範圍內 ( $f_{RSI}$  值在 0.7 的極限區域內)：測量範圍內可能有熱橋效應。應在更有利的環境條件 (例如：較低的外側溫度) 下再進行一次測量。
- 標示 (p) 在紅色範圍內 ( $f_{RSI}$  值低於 0.7，含誤差)：測量範圍內極可能存在熱橋效應。

### 露點模式

本測量裝置可協助找出容易發霉的地方。

根據在此模式下額外測得的環境溫度和相對空氣濕度 (參見「相對空氣濕度」, 頁 37), 可計算出露點溫度 (參見「露點溫度」, 頁 37)。同時, 露點溫度會與測得的表面溫度進行比較, 並針對發霉風險進行詮釋。

請注意, 測量結果只能呈現基於當前環境條件所作的當下紀錄。無法針對可能變更的環境條件進行預測。測量結果若不佳, 應於其他時間和不同的條件下再進行一次測量。

按下測量按鈕 (4), 即可開始進行測量。顯示器上所顯示的測量值會持續更新。

結束測量後, 最後一個測量標的物的表面溫度便會確認顯示在指示器 (n) 中, 環境溫度確認顯示在指示器 (h) 中, 相對空氣濕度則確認顯示在指示器 (g) 中。計算出的露點溫度會顯示在 (i) 中。

本測量工具有助於將數值的詮釋自動以標示 (p) 顯示在結果量表 (k) 上:

- 標示 (p) 在綠色範圍內: 在目前的條件下, 無發霉之虞。
- 標示 (p) 在黃色範圍內: 數值位於極限範圍內; 請注意室溫、熱橋效應以及濕度, 必要時可於一段時間後再進行一次測量。
- 標示 (p) 在紅色範圍內: 發霉危險增加, 因為濕度太高或表面溫度接近露點溫度範圍。異常的數值會在指示器中閃爍。

表面溫度達露點溫度的 80 % 時, 系統就會發出發霉危險警告。

**提示:** 使用本測量工具無法測得黴菌孢子。它僅能顯示, 在相同的條件下可能會發霉。

### 接觸溫度模式

進行接觸溫度測量時, 可使用一般市售類型 K 的屏蔽型熱耦線直接測量標的物的溫度。

接觸溫度測量是無接觸式溫度測量非常實用的補充。特別是在因原理之故無法使用紅外線測量的情況下, 接觸溫度測量就非常實用, 例如: 測量媒介、液體、氣流或低發射率 (無塗層的金屬) 表面的溫度時。

專門針對液體、氣流或表面等不同應用而優化的探測器幾何設計, 有助於使用合適探測器進行正確的測量。

請詳讀並遵守熱耦線製造商的提示。

因原理之故, 使用熱耦線必須直接接觸到測量標的物。此時請注意可能發生的危險和安全注意事項。在此模式下, 僅測量溫度探測器的溫度, 其他測量標的則排除。

**提示:** 請僅使用類型 K 的屏蔽熱耦線。若連接其他類型的熱耦線, 可能會出現錯誤的測量結果。

掀開護蓋 (1), 將熱耦線接在連接頭 (25) 上。

熱耦線一接上, 顯示器上就會出現指示器 (n)。該指示器中的測量值會持續更新。在此模式下, 若要測量, 無須按下測量按鈕 (4), 且雷射器是關閉的。請稍候, 當測量值不再變更時, 即為確認的結果。視熱耦線的規格而定, 可能需要數分鐘。

但在所有模式下除了測量表面溫度, 也能額外測量接觸溫度。其測量值會顯示在其他地方 (s)。但若若要測定熱橋效應和發霉危險, 則一律必須參考表面溫度 (n)。

拆除熱耦線時, 顯示器上的功能指示燈 (s) 會熄滅。拆下熱耦線後, 請重新關閉護蓋 (1)。

### 使用者模式

在使用者模式下, 系統會測量表面溫度、環境溫度和相對空氣濕度。從這些溫度數值可計算出露點溫度和平均溫度 (測量期間的表面溫度平均值)。

若有需求, 可隱藏指示器中的以下數值: 平均溫度、相對空氣濕度、環境溫度和露點溫度。

此時, 請先開啟 (參見「在 <主功能表> 中瀏覽」, 頁 35) 上的 <主功能表>。選擇子選單 <使用者模式>。您可在這處啟動和關閉 <平均溫度>、<空氣濕度>、<室溫> 和 <結露> 的指示器。

表面溫度測量時可選擇是否自動調整結果量表 (k) 的最小值和最大值 (j) 或手動確認。此時請進入選單 <使用者模式> 的子選單 <刻度範圍>。

- 若要和表面溫度模式一樣自動測得數值 (j), 請選擇 <自動>。測量值的差異一旦大於 3 °C, 測量程序的最小和最大溫度值會顯示在指示器 (j) 中。
- 請選擇 <預設>, 以手動確認數值。在選單 <使用者模式> 的 <刻度下限值> 和 <刻度的上限值> 中設定所需數值。指示器 (j) 中便會出現手動設定的最小值和最大值。如此一來, 即可例如: 透過標示 (p) 比較各種不同測量的螢幕畫面。

### 表面溫度警報

在所有模式下, 除接觸溫度測量之外, 還可使用表面溫度警報。可設定最小和最大溫度。

當溫度低於 **最小溫度** 時, 溫度警報指示器 (m) 便會閃藍燈, 若已啟動聲音訊號, 則還會響起警示訊號。

當溫度高於 **最大溫度** 時, 溫度警報指示器 (m) 便會閃紅燈, 若已啟動聲音訊號, 則還會響起警示訊號。

若要使用表面溫度警報, 請開啟 (參見「在 <主功能表> 中瀏覽」, 頁 35) 上的 <主功能表>。

- 選擇子選單 <警報>。
- 將 <警示音 最小/最大> 調為 <開>。
- 在 <最低溫度警告> 中設定最小溫度。
- 在 <最高溫度警告> 中設定最大溫度。

將警報調為 <關> 時, 也會儲存最小和最大溫度。

### 資料傳輸

#### 儲存/顯示/傳送測量結果

測量結束後, 顯示器上會出現此儲存符號, 表示可儲存測量結果。請按下儲存按鈕/發送按鈕 (9)。測量結果隨即儲存為 JPG 檔案 (固定顯示器的螢幕畫面)。



- 若要 **顯示** 儲存的螢幕畫面, 請按下圖庫符號 (q) 下方的左側功能按鈕 (17)。顯示器上隨即顯示最後儲存的畫面。

- 按下右側箭頭按鈕 (11) 或左側箭頭按鈕 (15)，即可在儲存的螢幕畫面之間來回切換。
- 若要透過 藍牙® 傳送儲存的測量結果，請按下儲存按鈕/發送按鈕 (9)。若尚未開啟 藍牙® 連接 (參見「透過藍牙® 功能傳輸資料」，頁 35)，按下儲存按鈕/發送按鈕時便會啟動連接。



- 若要刪除所示的螢幕畫面，請按下垃圾桶符號下方的右側功能按鈕 (10)。



- 若要確認刪除程序，請按下打勾符號下方的左側功能按鈕 (17)。



- 若要取消刪除程序，請按下十字符號下方的右側功能按鈕 (10)。



- 若要退出圖庫視圖，並返回測量模式，請按下返回符號下方的左側功能按鈕 (17)。

您也可以一次刪除所有儲存的檔案 (參見「<刪除所有圖片>」，頁 36)。

#### 透過 USB 連接介面傳輸資料

打開 Micro-USB 插孔護蓋 (1)。透過隨附的 Micro-USB 電纜 (8) 將測量工具的 Micro USB 插孔 (26) 與電腦連接。

現在即可按下電源按鈕 (12)，啟動本測量工具。

打開電腦上的檔案瀏覽器，選擇磁碟機 **GIS 1000 C**。即可從測量工具的內部記憶體複製已儲存的檔案、將檔案移至電腦或刪除。

完成所需程序後，請立即按標準程序斷開磁碟機與電腦的連線，然後利用電源按鈕 (12) 重新關閉測量工具。

**注意：**請先將磁碟機從作業系統卸除 (退出磁碟機)，否則測量工具的內部記憶體可能會受損。在測量運行期間拔下 Micro-USB 電纜，並關上護蓋 (1)。

USB 介面的保護蓋板請隨時保持關閉，這樣才不會有灰塵或噴濺的液體跑進機殼內。

**提示：**透過 USB 僅能將測量工具與電腦連接。若與其他裝置連接，測量工具可能會受損。

#### 透過藍牙® 功能傳輸資料

本測量工具配備 藍牙® 模組，可將資料從測量工具無線傳輸至行動終端裝置。其可使用專門的博世應用程式 (App) 來進行此功能。您可到相關商店按照所使用的終端裝置下載該程式。



Download on the  
**App Store**



ANDROID APP ON  
**Google play**

透過博世應用程式可擴充功能範圍 (除了無線資料傳輸)，還能簡化測量資料的後置加工和轉發作業 (例如：透過電子郵件)。有關使用 藍牙® 連接的必要系統條件資訊，請參閱博世網頁：  
[www.bosch-professional.com/thermal](http://www.bosch-professional.com/thermal)。

若要開啟測量工具上的 藍牙® 連接，請開啟 (參見「在 <主功能表> 中瀏覽」，頁 35) 上的 <主功能表>，並將 <藍牙> 調至 <開>。顯示器上隨即出現指示器 (e)。請確認：行動終端裝置上的 藍牙® 介面已啟用。

啟動博世應用程式後，(藍牙® 模組啟動時) 便會建立行動終端裝置和測量工具之間的連接。萬一同時找到多個已啟用的測量工具，請您選擇相符的那一個測量工具。如果只找到一個已啟用的測量工具，將自動執行建立連線。

**提示：**測量工具和行動終端裝置 (例如：智慧型手機、平板) 之間首度建立連接 (配對) 時，系統可能會查詢測量工具的 PIN 碼。在這種情況下，請輸入「0000」。

透過 藍牙® 傳輸資料時，可能會因收訊不良導致行動終端裝置和測量工具之間出現時間遲滯現象。

#### <主功能表>

##### 在 <主功能表> 中瀏覽



- 若要進入 <主功能表>，在標準顯示螢幕上按下選單符號 (I) 下方的右側功能按鈕 (10)。

- 若要在某一選單層級中瀏覽，請反覆按壓往上箭頭按鈕 (16) 或往下箭頭按鈕 (13)，直至所需的選單項目以彩色高亮顯示。



- 若高亮顯示的選單項目中還有子選單，則該子選單會以 <設定> 旁的向右箭頭標示。若要進入該子選單，請按下右側箭頭按鈕 (11)。



- 若高亮顯示的選單項目中有數個選項，則會顯示兩個箭頭之間的目前設定。若要變更此設定，請按下左側箭頭按鈕 (15) 或右側箭頭按鈕 (11)。按住相應箭頭按鈕時，數值會快速改變。

- 有些選單項目可啟動或關閉功能。若要關閉，請按下左側箭頭按鈕 (15)，隨即便會高亮顯示 <關>。若要啟動，請按下右側箭頭按鈕 (11)，隨即便會高亮顯示 <開>。亦可按下儲存按鈕/發送按鈕 (9)，來啟動和關閉選單內的功能。



- 若要切換至上層選單，請按下返回符號下方的左側功能按鈕 (17)。所選設定隨即儲存。



- 若要退出 <主功能表>，直接返回標準顯示螢幕，請按下房子符號下方的右側功能按鈕 (10)。所選設定隨即儲存。



- 若要退出任一選單，並返回標準顯示螢幕，亦可按下測量按鈕 (4)。按下按鈕即可儲存所選設定，但不會觸發測量作業。

### 測量子選單

#### <發射率> (t)

本產品中已預先儲存了一些最常見材質的發射率，供您選擇。為方便搜尋，發射率目錄中已分組彙整了數值。請先在選單項目 <材質> 中選擇合適的類別，然後再選擇合適的材料。其下便是該材質的發射率。如果已知測量標的物的準確發射率，則可直接在選單項目 <發射率> 中設定此數值。

若須經常測量相同材料，可將 5 種發射率設為最愛設定，即可透過最上方列 (編號 1 至 5) 快速開啟。

#### <反射溫度> (t)

設定此參數可提升測量品質，特別是測量低發射率材質 (= 高反射率) 時。在部分情況 (特別是在室內) 下，反射溫度等於環境溫度。高反射性物件附近若有溫度落差大的物體，這些物體可能會影響到測量，應調整此數值的設定。

#### 子選單 <裝置>

開啟 <主功能表>，並選擇子選單 <裝置>。其包含以下選單項目。

#### <語言>

可在選單 <語言> 中變更所有指示器的語言。

#### <時間與日期>

若要變更指示器 (a) 中的日期和時間，請開啟子選單 <時間與日期>。在此子選單中還可變更時間和日期格式。

若要退出子選單 <時間與日期>，請按下左側功能按鈕 (17)，儲存設定，或按下右側功能按鈕 (10)，捨棄變更。

#### <單位>

可在選單 <單位> 中選擇溫度資料以 <°C> 或 <°F> 顯示。

#### <雷射>

可在選單 <雷射> 中啟動或關閉測量裝置的雷射器。雷射器可用來限制測量面的範圍，因此應僅於例外情況時關閉。

#### <測量框>

可在選單 <測量框> 中啟動或關閉顯示器上的測量框 (b)。

#### <色彩配置>

可在選單 <色彩配置> 中選擇，溫度值和其他資料要在顯示器上以何種顏色顯示。該設定也將適用於儲存的螢幕畫面。

#### <關機時間>

可在選單 <關機時間> 中選擇，未操作任何按鈕時，測量工具自動關機的時間間隔。您也可以選擇此設定 <永不>，來停用自動關機功能。設定的關機時間越短，越節省能源。

#### <全亮持續時間>

可在選單 <全亮持續時間> 中選擇，未在測量工具上操作任何按鈕時，顯示器照明降低亮度的時間間隔。您也可以選擇此設定 <一律全亮>，讓顯示器持續亮著。設定的照明時間越短，越節省能源。

#### <聲音訊號>

可在選單 <聲音訊號> 中啟動或關閉表面溫度警報發出時的聲音訊號。

#### <刪除所有圖片>

可在選單 <刪除所有圖片> 中一次刪除位於內部記憶體中的所有檔案。按下 <其他> 的右側箭頭按鈕 (11)，即可進入子選單。然後再按下右側功能按鈕 (10)，以刪除全部檔案，或按下左側功能按鈕 (17)，取消程序。



#### <裝置資訊>

有關測量工具的資訊，請開啟子選單 <裝置資訊>。您可在此處找到測量工具的序號及其安裝的軟體版本。

#### <出廠重新設定>

可在此選單項目中將測量工具重置為原廠設定，並永久刪除所有資料。這可能需要數分鐘時間。按下 <其他> 的右側箭頭按鈕 (11)，即可進入子選單。然後再按下右側功能按鈕 (10)，以刪除全部檔案，或按下左側功能按鈕 (17)，取消程序。

## 故障 - 原因和補救方法

故障	原因	補救措施
測量工具無法啟動。 	充電電池或電池沒電 充電電池溫度太高或太低	請為充電電池充電或更換電池。 讓充電電池溫度回溫或更換電池。
	圖片儲存記憶體故障 圖片儲存記憶體已滿	刪除全部圖片，以進行內部記憶體格式化 (參見「<刪除所有圖片>」，頁 36)。若問題依舊存在，請將測量工具寄至授權的博世客戶服務中心。 必要時，將圖片傳輸至另一個記憶體媒體 (例如：桌上型電腦或筆記型電腦)。然後刪除內部記憶體的圖片。
	測量工具故障	將測量工具寄至授權的博世客戶服務中心。

故障	原因	補救措施
接觸溫度測量的功能指示燈 (s) 不會出現在顯示器上。	熱耦線的連接頭 (25) 或熱耦線故障	請檢查熱耦線的功能，並將測量工具寄至授權的博世客戶服務中心。
測量工具無法與電腦連接。	電腦無法偵測到測量工具。	請檢查電腦上的驅動程式是否為最新版本。必要時可能必須更新電腦上的作業系統版本。
	Micro-USB 連接埠或 Micro-USB 電纜故障	請檢查，測量工具是否能與另一台電腦連接。若不能，請將測量工具寄至授權的博世客戶服務中心。
	空氣濕度和環境溫度感應器 (5) 故障	測量工具的其他功能仍可使用。將測量工具寄至授權的博世客戶服務中心。

## 名詞解釋

### 紅外線熱輻射

紅外線熱輻射高於 0 Kelvin (-273 °C) 是一種人體散發出來的電磁輻射。其輻射量視人體的溫度和發射率而定。

### 發射率

測量標的物的發射率根據其材質及表面結構而有所不同。此值代表，相較於理想的熱輻射物體（即黑體，其發射率  $\epsilon = 1$ ），測量標的物所釋放的紅外線熱輻射量，因此為 0 至 1 之間的數值。

### 反射溫度 / 物體的反射特性

所謂反射溫度係指非物體自身發散的熱輻射。視結構和材料而定，待測量物件內的環境輻射會反射，因而影響到實際的溫度結果。

### 熱橋效應

熱橋效應係指建築物外壁一處因結構因素出現局部熱損失增加的情況。

若要評估熱橋效應，可參考 DIN 4108-2 所述的隔熱保護最低要求。

根據 DIN 4108-2，當溫度係數  $f_{Rsi}$  大於 0.7 時，應遵守隔熱保護的最低要求。

溫度係數  $f_{Rsi}$  的計算方式如下：

$$f_{Rsi} = \frac{T_1 - T_2}{T_3 - T_2}$$

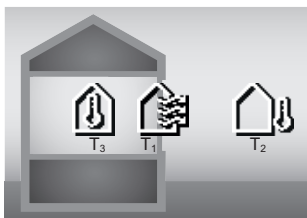

$T_1$ ：內側表面溫度

$T_2$ ：外側溫度

$T_3$ ：內側環境溫度

最小隔熱保護可避免在標準條件下發霉。如此可避免危及建築物質。

在標準條件（外側溫度 -5 °C、內側環境溫度 20 °C）下，表面溫度不能降至 12.6 °C 以下。這相當於  $f_{Rsi}$  極限值 0.7。若要取得極具說服力的結果（不確定性極小），外側溫度應低於 10 °C。

### 相對空氣濕度

相對空氣濕度係指空氣中水蒸氣的飽和程度。該資訊會以百分比數值表示空氣可吸收的最大水蒸氣量。最大水蒸氣量取決於溫度：溫度越高，空氣可吸收越多水蒸氣。

相對空氣濕度若太高，發霉的可能性就越高。空氣濕度太低可能會影響到健康。

### 露點溫度

露點溫度係為空氣中所含水蒸氣開始凝結的溫度。露點溫度取決於相對空氣濕度和空氣溫度。

表面的溫度若低於露點溫度，該表面上的水就會開始凝結。

表面上的冷凝水是導致發霉的主因之一。

## 維修和服務

### 維修和清潔

測量儀器必須隨時保持清潔。髒污的紅外線接收鏡頭 (23) 可能會影響測量準確度。

使用乾燥軟布擦拭污垢。切勿使用清潔劑或溶液。進行清潔時，切勿讓任何液體滲入測量工具。

尤其是要小心清潔空氣濕度和溫度感應器 (5)、攝影機 (22)、接收鏡頭 (23)、照明裝置 (24) 和雷射射出口 (2)：請注意，攝影機、接收鏡頭或雷射射出口不能有棉絮殘留。請僅使用適用於攝影鏡頭的清潔工具來清潔攝影機、接收鏡頭和雷射射出口。請勿試圖用尖銳物品去除感應器、攝影鏡頭或接收點上的髒污，亦不可直接擦拭攝影鏡頭與接收點（可能造成細微刮痕）。

請勿長時間將測量工具存放在空氣濕度範圍 30 至 50 % 之外的條件中。存放測量工具的環境若太潮濕或太乾燥，該測量工具運行時可能出現錯誤測量的現象。

由於原理之故，濕度感應器對溶劑、黏著劑和增塑劑非常敏感。若長時間受到這些物質的影響，所測得的濕度可能會出現偏差。

請勿將測量裝置存放在其蒸發可能會影響空氣濕度和溫度感應器 (5) 的塑膠袋中。不可在測量工具的感應器附近黏貼任何帶膠籤條。

若希望重新校正您的測量工具，請洽詢授權的博世客戶服務中心。

儲放和搬運測量工具時，一定要將它放置在隨附的保護套袋內。

如需送修，請將測量工具放入保護套袋內後，再轉交給相關單位。

### 顧客服務處和顧客諮詢中心

本公司顧客服務處負責回答有關本公司產品的維修、維護和備用零件的問題。以下的網頁中有分解圖和備用零件相關資料：[www.bosch-pt.com](http://www.bosch-pt.com)

如果對本公司產品及其配件有任何疑問，博世應用諮詢小組很樂意為您提供協助。

當您需要諮詢或訂購備用零件時，請務必提供本產品型號銘牌上 10 位數的產品機號。

### 台灣

台灣羅伯特博世股份有限公司

建國北路一段90 號6 樓

台北市10491

電話: (02) 7734 2588

傳真: (02) 2516 1176

[www.bosch-pt.com.tw](http://www.bosch-pt.com.tw)

### 製造商地址:

Robert Bosch Power Tools GmbH

羅伯特·博世電動工具有限公司

70538 Stuttgart / GERMANY

70538 斯圖加特/ 德國

### 以下更多客戶服務處地址：

[www.bosch-pt.com/serviceaddresses](http://www.bosch-pt.com/serviceaddresses)

### 搬運

隨貨附上的鋰離子充電電池受危險物品法的規範。使用者無須另外使用保護包裝便可運送該充電電池。

但是如果將它交由第三者運送（例如：寄空運或委託運輸公司），則應遵照包裝與標示的相關要求。此時必須向危險物品專家請教有關寄送危險物品的相關事宜。

確定充電電池的外殼未受損後，才可以寄送充電電池。用膠帶貼住裸露的接點並妥善包裝充電電池，不可以讓充電電池在包裝材料中晃動。同時也應留意各國相關法規。

### 廢棄物處理



測量工具、充電電池／拋棄式電池、配件以及包裝材料須遵照環保相關法規進行資源回收。



不得將本測量工具與充電電池／拋棄式電池丟入家庭垃圾中！

### 僅適用於歐盟國家：

依據歐盟指令 2012/19/EU，無法再繼續使用的測量工具必須分別收集起來，然後遵照環保相關法規進行資源回收。而歐盟指令 2006/66/EC 中則要求已故障或汰換下來的充電電池／拋棄式電池亦須比照辦理。

### 充電電池／一般電池：

#### 鋰離子：

請注意「搬運」段落中的指示（參見「搬運」，頁 38）。

### 有關台灣的更多資訊

#### NCC 警語

低功率電波輻射性電機管理辦法

第十二條經型式認證合格之低功率射頻電機，非經許可，公司，商號或使用者均不得擅自變更頻率，加大功率或變更原設計之特性及功能。

第十四條低功率射頻電機之使用不得影響飛航安全及干擾合法通信；經發現有干擾現象時，應立即停用，並改善至無干擾時方得繼續使用。

前項合法通信，指依電信規定作業之無線電信。

低功率射頻電機須忍受合法通信或工業，科學及醫療用電波輻射性電機設備之干擾。

## 한국어

### 안전 수칙



측정공구의 안전한 사용을 위해 모든 수칙들을 숙지하고 이에 유의하여 작업하시기 바랍니다. 측정공구를 해당 지침에 따라 사용하지 않으면, 측정공구에 내장되어 있는 안전장치에 안 좋은 영향을

미칠 수 있습니다. 측정공구의 경고판을 절대로 가려서는 안 됩니다. 안전 수칙을 잘 보관하고 공구 양도 시 측정공구와 함께 전달하십시오.

▶ 주의 - 여기에 제시된 조작 장치 또는 조정 장치 외의 용도로 사용하거나 다른 방식으로 작업을 진행하는 경우, 광선으로 인해 폭발될 위험이 있습니다.

▶ 본 측정공구는 레이저 경고 스티커가 함께 공급됩니다(그림에 측정공구의 주요 명칭 표시).

▶ 처음 사용하기 전에 함께 공급되는 한국어로 된 레이저 경고 스티커를 독문 경고판 위에 붙이십시오.





사람이나 동물에게 레이저 광선을 비추거나, 광선을 직접 또는 반사시켜 보지 마십시오. 이로 인해 눈이 부시게 만들어 사고를 유발하거나 눈에 손상을 입을 수 있습니다.

▶ 눈으로 레이저 광선을 쳐다본 경우, 의식적으로 눈을 감고 곧바로 고개를 돌려 광선을 피하십시오.

▶ 레이저 장치를 개조하지 마십시오.

▶ 레이저 보안경(액세서리)을 일반 보안경으로 사용하지 마십시오. 레이저 보안경은 레이저 광선을 보다 잘 감지하지만, 그렇다고 해서 레이저 광선으로부터 보호해주는 것은 아닙니다.

- ▶ 레이저 보안경(액세서리)을 선글라스 용도 또는 도로에서 사용하지 마십시오. 레이저 보안경은 자외선을 완벽하게 차단하지 못하며, 색상 분별력을 떨어뜨립니다.
  - ▶ 측정공구의 수리는 해당 자격을 갖춘 전문 인력에게 맡기고, 수리 정비 시 순정 부품만 사용하십시오. 이 경우에만 측정공구의 안전성을 오래 유지할 수 있습니다.
  - ▶ 어린이가 무감독 상태로 레이저 측정공구를 사용하는 일이 없도록 하십시오. 의도치 않게 타인 또는 자신의 눈이 부시게 할 수 있습니다.
  - ▶ 가연성 유체나 가스 혹은 분진 등 폭발 위험이 있는 곳에서 측정공구를 사용하지 마십시오. 측정공구에 분진이나 증기를 접화하는 스파크가 생길 수 있습니다.
  - ▶ 배터리를 분해하지 마십시오. 단락이 발생할 위험이 있습니다.
  - ▶ 배터리가 손상되었거나 잘못 사용될 경우 증기가 발생할 수 있습니다. 배터리에서 화재가 발생하거나 폭발할 수 있습니다. 작업장을 환기시키고, 필요한 경우 의사와 상담하십시오. 증기로 인해 호흡기가 자극될 수 있습니다.
  - ▶ 배터리를 잘못 사용하거나 배터리가 손상된 경우, 배터리에서 가연성 유체가 흘러나올 수 있습니다. 누수가 생긴 배터리에 닿지 않도록 하십시오. 피부에 접하게 되었을 경우 즉시 물로 씻으십시오. 유체가 눈에 닿았을 경우 바로 의사와 상담하십시오. 배터리에서 나오는 유체는 피부에 자극을 주거나 화상을 입힐 수 있습니다.
  - ▶ 못이나 스크류 드라이버 같은 뾰족한 물체 또는 외부에서 오는 충격 등으로 인해 축전지가 손상될 수 있습니다. 내부 단락이 발생하여 배터리가 타거나 연기가 발생하고, 폭발 또는 과열될 수 있습니다.
  - ▶ 배터리를 사용하지 않을 때는 각 극 사이에 브리징 상태가 생길 수 있으므로 페이퍼 클립, 동전, 열쇠, 못, 나사 등 유사한 금속성 물체와 멀리하여 보관하십시오. 배터리 극 사이에 쇼트가 일어나 화상을 입거나 화재를 야기할 수 있습니다.
  - ▶ 제조사의 배터리 제품만 사용하십시오. 그래야만 배터리 과부하의 위험을 방지할 수 있습니다.
  - ▶ 배터리는 제조사에서 권장하는 충전기에만 충전하십시오. 특정 제품의 배터리를 위하여 제조된 충전기에 적합하지 않은 다른 배터리를 충전할 경우 화재 위험이 있습니다.
- 

배터리를 태양 광선 등 고열에 장시간 노출되지 않도록 하고 불과 오염물질, 물, 수분이 있는 곳에 두지 마십시오. 폭발 및 단락의 위험이 있습니다.
- ▶ 측정공구에서 각종 작업(예: 설치, 유지보수 작업 등)을 하기 전이나, 측정공구를 운반하거나 보관하기 전에 반드시 충전용 배터리를 측정공구로부터 분리하십시오. 실수로 전원 스위치가 작동하게 되면 부상을 입을 위험이 있습니다.
  - ▶ 주의! 측정공구의 블루투스® 사용은 다른 기기나 설비, 비행기 및 의료기기(예: 심박 조절기, 보청기) 등에 장애를 가져올 수 있습니다. 마찬가지로 근처에 있는 동물이나 사람에게도 좋지 않은 영향을 미칠 수 있습니다. 측정공구의 블루투스® 사용은 의료 기기, 주유소, 화학설비 및 폭발 위험이 있는 주변에서는 삼가하십시오. 비행기에서 측정공구의 블루투스® 사용은 삼가하십시오. 오랜 시간 신체에 직접 접촉하여 작동하는 것을 삼가하십시오.

- ▶ 해당 무선설비는 전파혼신 가능성이 있으므로 인명안전과 관련된 서비스는 할 수 없습니다.
- 블루투스® 워드마크와 그림(로고)은 Bluetooth SIG, Inc.의 등록상표입니다. Robert Bosch Power Tools GmbH는 허가를 받아 이를 사용하고 있습니다.
- ▶ 본 측정공구의 습도 센서, 주변 온도 센서 및 적외선 센서 부분은 특히 습기, 강설, 먼지 및 오염물이 유입되지 않도록 보호하십시오. 수신 렌즈에 성애가 끼거나 오염 물질이 묻으면 측정 결과가 왜곡될 수 있습니다. 장치 설정이 올바르게 작동하지 않거나 기타 주변 대기의 영향 또한 측정 결과가 틀려지는 요인이 될 수 있습니다. 측정 객체의 온도가 너무 높게 혹은 너무 낮게 나타날 수 있으며, 이러한 경우 접촉하게 되면 위험할 수 있습니다.
  - ▶ 온도는 설정된 방사율과 측정 객체의 방사율이 일치하고 반사 온도가 올바르게 설정되어 있을 때만 정확하게 측정됩니다. 측정 객체의 온도가 너무 높게 혹은 너무 낮게 나타날 수 있으며, 이러한 경우 접촉하게 되면 위험할 수 있습니다.

### 열전대 사용에 관한 안전 수칙

- ▶ 열전대는 통전되는 전기 설비에 사용해서는 안 됩니다. 생명이 위험할 수 있습니다!
- ▶ 열전대를 사용하면 측정 대상에 접촉하게 됩니다. 온도, 전압 또는 화학 반응으로 인한 잠재적 위험에 유의하십시오.

### 제품 및 성능 설명

사용 설명서 앞 부분에 제시된 그림을 확인하십시오.

### 규정에 따른 사용

본 측정공구는 표면 온도, 주변 온도 및 상대 습도를 비접촉 방식으로 측정하는 용도로 사용됩니다. 이슬점 온도를 계산하고 열교와 곰팡이 발생 위험을 알려줍니다. 본 측정공구는 곰팡이 포자를 찾을 수 없습니다. 그러나 곰팡이 성장이 촉진될 수 있는 조건들을 조기에 확인하는 데 도움을 줄 수 있습니다. 사람이나 동물의 체온을 측정하거나, 기타 의학적 용도로 사용해서는 안 됩니다. 본 측정공구는 기체의 표면 온도 측정에 적합하지 않습니다. 액체의 온도 측정은 열전대(K 타입 커넥터)를 사용해야만 가능하며, 열전대는 해당하는 인터페이스 (25) 를 사용해 측정공구에 연결할 수 있습니다. 열전대를 통해 표면에 접촉하여 표면 온도를 측정할 수 있습니다.

## 40 | 한국어

측정공구의 조명은 이미지 촬영 시 직접적으로 작업 영역을 비추는 용도로 사용됩니다.

레이저 포인트는 레이저 포인트로 사용할 수 없습니다. 측정 표면을 표시하는 용도로만 사용됩니다.

측정공구는 실내 및 실외에서 모두 사용할 수 있습니다.

### 제품의 주요 명칭





제품의 주요 명칭에 표기되어 있는 번호는 측정공구의 그림이 나와있는 면을 참고하십시오.

- (1) 마이크로 USB 소켓 커버/열전대 커넥터(K 타입)
- (2) 레이저빔 발사구
- (3) 배터리 잠금해제 버튼/배터리 어댑터/배터리 케이스 덮개
- (4) 측정 버튼/켜기 버튼
- (5) 습도 센서 및 주변 온도 센서
- (6) 일련 번호
- (7) 레이저 경고판
- (8) 마이크로 USB 케이블
- (9) 메모리 버튼/전송 버튼 (블루투스®)
- (10) 오른쪽 기능 버튼
- (11) 오른쪽 화살표 버튼
- (12) 전원 버튼
- (13) 아래쪽 화살표 버튼/줌 레벨 내림
- (14) 조명 전원 버튼
- (15) 왼쪽 화살표 버튼
- (16) 위쪽 화살표 버튼/줌 레벨 높임
- (17) 왼쪽 기능 버튼
- (18) 디스플레이
- (19) 습도 센서 및 주변 온도 센서의 보호캡
- (20) 운반용 끈 끼우는 부위
- (21) 적외선 수신 렌즈 보호캡
- (22) 카메라
- (23) 적외선 수신 렌즈
- (24) 조명
- (25) 열전대용 K 타입 커넥터
- (26) 마이크로 USB 단자
- (27) 배터리 어댑터 캡<sup>a)</sup>
- (28) 배터리 어댑터 쉘링캡<sup>a)</sup>
- (29) 배터리 슬롯
- (30) 배터리<sup>a)</sup>

### (31) 배터리 케이스 덮개<sup>a)</sup>

- a) 도면이나 설명서에 나와있는 액세서리는 표준 공급부품에 속하지 않습니다. 전체 액세서리는 저희 액세서리 프로그램을 참고하십시오.

### 디스플레이 요소(그림 A 참조)

- (a) 날짜/시간 (참조 „<시간 & 날짜>“, 페이지 47)
- (b) 측정 프레임 (참조 „표면 온도 측정 시 측정 표면“, 페이지 43)
- (c) 상태 표시기:
  -  측정공구가 측정 준비가 되어 있음, 측정 버튼 (4) 누르기.
  -  (연속) 측정 작동 중, 레이저가 켜짐.
  -  측정이 종료됨, 레이저가 꺼짐, 측정 결과가 잠김.
  -  접촉 온도 모드, 레이저가 비활성화됨, 열전대를 통해서만 측정이 작동됨.
- (d) 줌 레벨 표시기 (참조 „줌 레벨 설정하기“, 페이지 44)
- (e) 블루투스® 표시기가 켜짐 (참조 „블루투스®를 통한 데이터 전송“, 페이지 46)
- (f) 충전상태 표시기
- (g) 기능 표시기/상대 습도 측정값
- (h) 기능 표시기/주변 온도 측정값
- (i) 기능 표시기/이슬점 온도 결과
- (j) 측정 과정 동안 최소/최고 표면 온도 측정값
- (k) 측정 등급
- (l) 메뉴 기호
- (m) 표면 온도 경보 표시기 (참조 „표면 온도 경보“, 페이지 46)
- (n) 측정값
- (o) 현재 모드
- (p) 측정값 표시 및 결과(선택한 모드에 따라 달라짐)
- (q) 갤러리 기호
- (r) 기능 표시기/평균 온도 측정값
- (s) 기능 표시기/접촉 온도 측정값
- (t) 방사율 표시기/방사 온도
- (u) 설정된 실외 온도 (열교 모드)
- (v)  $f_{Rsi}$  값 표시기(허용 오차 포함) (열교 모드)

### 제품 사양

열 감지기	GIS 1000 C	GIS 1000 C
품번	3 601 K83 3..	3 601 K83 371
작업 영역	0.1-5 m	0.1-5 m
측정 영역		



열 감지기	GIS 1000 C	GIS 1000 C
- 표면 온도	-40 ... +1000 °C	-40 ... +1000 °C
- 접촉 온도	-40 ... +1000 °C	-40 ... +1000 °C
- 주변 온도	-10 ... +50 °C	-10 ... +50 °C
- 상대 습도	0 ... 100 %	0 ... 100 %
<b>측정 정확도<sup>A)</sup></b>		
<b>표면 온도<sup>B)</sup></b>		
-40 ... -20.1 °C	±2.5 °C	±2.5 °C
-20 ... -0.1 °C	±1.5 °C	±1.5 °C
<b>0 ... +100 °C</b>	<b>±1 °C</b>	<b>±1 °C</b>
+100 °C ... +400 °C	±1 %	±1 %
> +400 °C	±2 %	±2 %
<b>주변 온도</b>	±1 °C	±1 °C
<b>상대 습도<sup>C)</sup></b>		
< 20 %	±3 %	±3 %
<b>20 ... 60 %</b>	<b>±2 %</b>	<b>±2 %</b>
60 ... 90 %	±3 %	±3 %
광학 요소 (측정 간격 : 측정점 비율) <sup>D)E)</sup>	50 : 1	50 : 1
레이저 등급	2	2
레이저 유형	635 nm, < 1 mW	635 nm, < 1 mW
발산(발산각)	< 1.5 mrad	< 1.5 mrad
기준 높이를 초과한 최대 사용 높이	2000 m	2000 m
IEC 61010-1에 따른 오염도	2 <sup>F)</sup>	2 <sup>F)</sup>
최대 상대 습도	90 %	90 %
배터리(알칼리 망간)	4 × 1.5 V LIR6 (AA) (배터리 어댑터 포함)	4 × 1.5 V LIR6 (AA)
충전용 배터리(리튬 이온)	10.8V/12V	-
<b>작동시간</b>		
- 배터리(알칼리 망간)	3 h	3 h
- 충전용 배터리 (리튬 이온) <sup>G)</sup>	10 h	-
내부 화상 메모리의 이미지 개수	> 200	> 200
블루투스® (Classic and Low Energy)	4.2 <sup>H)</sup>	4.2 <sup>H)</sup>
작동 주파수 범위	2402-2480 MHz	2402-2480 MHz
최대 송신 출력	2.5 mW	2.5 mW
USB 연결부	2.0	2.0
EPTA-Procedure 01:2014에 따른 중량 <sup>G)</sup>	0.56-0.77 kg	0.51 kg
치수(길이 x 폭 x 높이)	136 × 89 × 214 mm	136 × 89 × 214 mm
<b>주변 온도</b>		
- 충전 시 권장되는 주변 온도	0 °C ... +35 °C	-
- 작동 시 허용되는 주변 온도	-10 °C ... +50 °C	-10 °C ... +50 °C
- 배터리 없이 보관 시 허용되는 주변 온도	-20 °C ... +70 °C	-20 °C ... +70 °C
- 배터리와 함께 보관 시 허용되는 주변 온도	-20 °C ... +50 °C	-
권장 배터리	GBA 10,8V... GBA 12V...	-

**열 감지기**

GIS 1000 C

GIS 1000 C

권장 충전기

GAL 12...

-

- A) 사용에 따른 편차 포함(예: 반사, 간격, 주변 온도)
- B) 주변 온도 +20 °C ... +23 °C, 방사율 > 0.999, 0.3 m, 구경 60 mm일 때
- C) 주변 온도 +15 °C ... +40 °C일 때
- D) VDI(독일 엔지니어 연합)/VDE(전기전자 정보 테크놀로지 협회) 3511 시트 4.3 (2005년 7월 발행)의 기재내용은 측정 신호의 90 %에 적용됩니다.  
기술 자료에 표시된 수치를 벗어난 모든 영역에서 측정 결과에 편차가 있을 수 있습니다.
- E) 적외선 측정 관련(그래픽 참조):

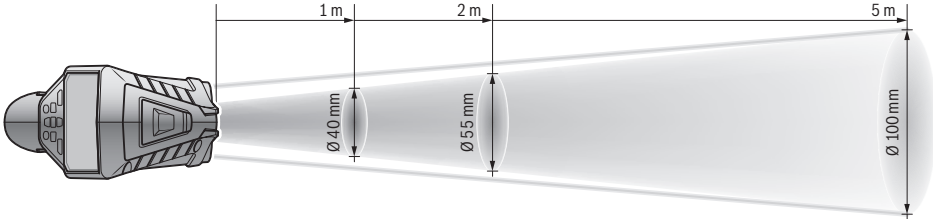

- F) 비전도성 오염만 발생하지만, 가끔씩 이슬이 맺히면 임시로 전도성이 생기기도 합니다.
  - G) 사용하는 배터리에 따라 상이
  - H) 블루투스® Low-Energy 장치의 경우, 모델과 작동 시스템에 따라 연결 구성이 불가능할 수 있습니다. 블루투스® 장치가 SPP 프로필을 지원해야 합니다.
- 측정공구를 확실하게 구분할 수 있도록 타입 표시판에 일련 번호 (6) 가 적혀 있습니다.

**조립**

**측정공구 전원 공급**

이 측정공구는 일반 배터리를 사용하거나 보쉬사의 리튬 이온-충전용 배터리를 사용할 수 있습니다.

품번 **3 601 K83 371**: 본 측정공구는 표준 배터리로만 작동 가능합니다.

**배터리를 사용한 작동(품번 3 601 K83 371 제외) (그림 B 참조)**

배터리를 배터리 어댑터에 삽입합니다.

- ▶ **본 배터리 어댑터는 보쉬 측정공구용으로만 사용되도록 고안되었으며, 전동공구와 함께 사용해서는 안 됩니다.**

배터리를 삽입하려면 배터리 어댑터 캡 (27) 을 배터리 슬롯 (29) 안으로 밀어 넣으십시오. 그림에 제시된 것처럼 씰링캡 (28) 의 배터리를 캡에 끼우십시오. 캡이 맞물려 끼워지는 느낌이 들도록 씰링캡을 캡 위로 미십시오.

배터리를 분리하려면 씰링캡 (28) 의 잠금해제 버튼 (3) 을 누른 뒤 씰링캡을 빼내십시오. 이때 배터리가 빠지지 않도록 주의하십시오. 그렇게 하기 위해서 배터리 슬롯 (29) 이 위를 향하도록 측정공구를 두십시오. 배터리를 꺼내십시오. 안쪽에 있는 캡 (27) 을 배터리 슬롯에서 분리하려면, 캡을 잡고 측면을 약간 돌려서 측정공구 밖으로 빼냅니다.

모든 배터리는 항상 동시에 교체하십시오. 한 제조사의 용량이 동일한 배터리로만 사용하십시오.

- ▶ **오랜 기간 사용하지 않을 경우 측정공구의 배터리를 빼두십시오.** 배터리를 측정공구에 오래 두면 부식되고 방전될 수 있습니다.



**배터리를 사용한 작동(품번 3 601 K83 371 제외) (그림 C 참조)**

- ▶ **기술자료에 기재되어 있는 충전기만 사용하십시오.** 측정공구에 사용된 리튬이온 배터리에는 이 충전기만 사용할 수 있습니다.

**지침:** 측정공구에 적합하지 않은 배터리를 사용하면 측정공구에 기능 장애가 생겨 기기가 손상될 수 있습니다.

**지침:** 배터리는 일부 충전되어 공급됩니다. 배터리의 성능을 완전하게 보장하기 위해서는 처음 사용하기 전에 배터리를 완전히 충전하십시오.

리튬이온 배터리는 항상 충전할 수 있으며, 이로 인해 수명이 단축되지 않습니다. 충전을 하다 중간에 중지해도 배터리가 손상되지 않습니다.

충전된 배터리 (30) 를 배터리 슬롯 (29) 에 삽입하려면, 배터리가 맞물려 끼워지는 느낌이 들고 측정공구의 손잡이에 나란히 위치할 때까지 밀어 넣으십시오.

배터리 (30) 를 분리하려면, 잠금해제 버튼 (3) 을 누르고 배터리를 배터리 슬롯 (29) 에서 빼내십시오. **무리하게 힘을 가하지 마십시오.**

**배터리를 사용한 작동(3 601 K83 371)(그림 D 참조)**

배터리 케이스 덮개 (31) 를 열려면, 잠금해제 버튼 (3) 을 누르고 배터리 케이스 덮개를 빼내십시오.

배터리를 끼울 때에는 그림에 제시된 것처럼 배터리 케이스 덮개의 전극이 일치하는지 확인하십시오.

배터리 케이스 덮개 (31) 를 다시 덮고 맞물리는 느낌이 들도록 끼우십시오.

모든 배터리는 항상 동시에 교체하십시오. 한 제조사의 용량이 동일한 배터리로만 사용하십시오.

- ▶ 오랜 기간 사용하지 않을 경우 측정공구의 배터리를 빼두십시오. 배터리를 측정공구에 오래 두면 부식되고 방전될 수 있습니다.

## 작동

### 기계 시동

- ▶ 측정공구가 물에 젖거나 직사 광선에 노출되지 않도록 하십시오.
- ▶ 극한의 온도 또는 온도 변화가 심한 환경에 측정공구를 노출시키지 마십시오. 예를 들어 장시간 차량 안에 측정공구를 두지 마십시오. 온도 변화가 심한 경우 측정공구를 작동시키기 전에 먼저 온도에 적응할 수 있게 하십시오. 극한 온도에서 나 온도 변화가 심한 환경에서 사용하면 측정공구의 정확도가 떨어질 수 있습니다.
- ▶ 측정공구가 환경에 제대로 적응되었는지 확인하십시오. 온도 차이가 심한 경우, 적응 시간은 최대 60 분까지 소요될 수 있습니다. 온도가 낮은 차량에 측정공구를 보관했다가 온도가 높은 건물에서 측정하는 경우가 이에 해당될 수 있습니다.
- ▶ 측정공구가 외부와 세계 부딪히거나 떨어지지 않도록 주의하십시오. 외부로부터 강한 충격을 받았거나, 기능적인 측면에 이상이 발생했다면 Bosch 공식 고객 서비스센터에 측정공구의 점검을 의뢰하는 것이 좋습니다.

### 전원 켜기/끄기

적외선 수신 렌즈 (23) 의 보호캡 (21), 습도 센서 및 주변 온도 센서 (5) 의 보호캡 (19) 을 분리하십시오. 작업하는 동안 카메라 (22), 수신 렌즈 (23) 및 센서 (5) 가 잠겨 있거나 덮여 있지 않도록 주의하십시오. 그렇지 않을 경우 올바른 측정이 불가능합니다.

측정공구의 전원을 켜려면, 전원 버튼 (12) 또는 측정 버튼 (4) 을 누르십시오. 디스플레이 (18) 에 시작 단계가 나타납니다. 시작 단계가 끝나면 측정공구는 마지막으로 전원이 꺼질 때 저장되었던 작동 모드에 있습니다. 레이저는 아직 켜지지 않은 상태입니다.

최초 작동 시에만 시작 단계에 이어서 추가적으로 <장치> 메뉴가 나타나는데, 여기에서 모든 표시기의 언어와 같은 측정공구의 설정을 지정할 수 있습니다 (참조 „하위 메뉴 <장치>“, 페이지 47). 오른쪽 기능 버튼 (10) 을 눌러 선택한 설정 내역을 확인하십시오. 모든 설정은 나중에 하위 메뉴 <장치> 에서 변경할 수도 있습니다.

- ▶ 측정공구가 켜져 있는 상태에서 자리를 비우지 말고, 사용 후에는 측정공구의 스위치를 끄십시오. 레이저빔으로 인해 다른 사람의 눈을 일시적으로 안 보이게 할 수 있습니다.
- ▶ 레이저빔이 사람이나 동물에 향하지 않도록 하고, 먼 거리에서라도 레이저빔 안을 들여다 보지 마십시오.

디스플레이 조명은 초기 설정 시 각 버튼을 누른 후 30초가 지나면 에너지 절약을 위해 밝기가 줄어듭니다. 아무 버튼이나 누르면 디스플레이 조명이 다시 최대 강도로 켜집니다. <항상 켜기> 메뉴에서 조

명 시간을 변경할 수 있습니다 (참조 „<항상 켜기>“, 페이지 48).

측정공구의 전원을 끄려면, 전원 버튼 (12) 을 누르십시오. 측정공구가 현재 작동 모드 및 설정을 저장한 뒤 절전로 꺼집니다. 보호캡 (21) 을 다시 수신 렌즈 (23) 위에 끼우고, 보호캡 (19) 을 습도 센서 및 주변 온도 센서 (5) 위에 끼우십시오.

배터리나 배터리 어댑터를 분리해서 측정공구의 전원을 끄지 마십시오. 이 경우 자칫하면 내부 메모리가 손상될 수 있습니다.

메인 메뉴에서 버튼 누름/측정이 없을 때 측정공구가 자동으로 꺼지는 설정과 꺼지는 시간에 대한 타이머를 설정할 수 있습니다 (참조 „<자동 꺼짐 시간>“, 페이지 47). 자동으로 꺼질 때에서도 현재 작동 모드와 설정이 저장됩니다.

배터리 또는 측정공구가 제품 사양에 나온 작동 온도를 벗어날 경우, 짧은 경고 (참조 „고장 - 원인 및 대책“, 페이지 48) 후 측정공구가 자동으로 꺼지게 됩니다. 측정공구의 열이 식으면 그때 다시 전원을 켜십시오.

### 측정 준비

#### 표면 온도 측정을 위한 방사를 설정

표면 온도를 결정하기 위해, 목표 대상이 발산하는 자연 적외선 열방출이 비접촉 방식으로 측정됩니다. 올바른 측정을 위해서는 측정하기 전에 항상 측정공구에 설정되어 있는 방사율을 점검하고 경우에 따라서는 측정 객체에 맞춰 조정하십시오.

측정공구에 사전 설정되어 있는 방사율은 기준값입니다.

사전 설정되어 있는 방사율 중 하나를 선택하거나 정확한 숫자값을 입력할 수 있습니다. 원하는 방사율을 <측정> → <방사율> 메뉴를 통해 설정하십시오 (참조 „<시작 메뉴>“, 페이지 47).

- ▶ 온도는 설정된 방사율과 측정 객체의 방사율이 일치하고 반사 온도가 올바르게 설정되어 있을 때만 정확하게 측정됩니다. 측정 객체의 온도가 너무 높게 혹은 너무 낮게 나타날 수 있으며, 이러한 경우 접촉하게 되면 위험할 수 있습니다.

방사율이 낮을수록 반사 온도가 측정 결과에 미치는 영향이 커집니다. 따라서 방사율을 변경할 때는 반드시 반사 온도를 조정하십시오. 원하는 방사율을 <측정> → <반사 온도> 메뉴를 통해 설정하십시오 (참조 „<시작 메뉴>“, 페이지 47).

레이저로 표시되는 측정 표면 안에 상이한 방사율을 가진 측정 객체가 여러 개 있을 경우, 온도 측정이 왜곡될 수 있습니다.

#### 표면 온도 측정 시 측정 표면

측정공구에서 만들어지는 레이저 포인트들은 원형 측정 표면의 테두리를 제한합니다. 표시되는 온도 측정값은 이 표면 안의 평균적인 표면 온도를 나타냅니다.

- ▶ 레이저빔이 사람이나 동물에 향하지 않도록 하고, 먼 거리에서라도 레이저빔 안을 들여다 보지 마십시오.

레이저 포인트의 간격과 그에 따른 측정 표면의 크기는 측정공구와 측정 객체 간의 간격에 따라 커집니다.

레이저 포인트를 확인하기가 어려울 때는 디스플레이에서 <프레임> (b) 을 켤 수 있습니다 (참조 „<프레임>“, 페이지 47). 측정 프레임은 측정 표면의 척도로 사용할 수 있고 방향 설정에 도움이 됩니다. 측정 간격에 따라서 측정 프레임은 측정 표면과 달라질 수 있습니다. 레이저 포인트 사이의 영역이 측정에 중요합니다.

#### 측정 조건에 관한 지침

강하게 반사되거나, 광택이 나거나, 투명한 표면(광택 타일, 스테인리스 스틸 전면 또는 냄비 등)은 표면 온도 측정에 영향을 줄 수 있습니다. 경우에 따라 측정표면에 열전도가 잘 되는 어두운 색의 무광택 접착 테이프를 부착하여 주십시오. 테이프가 표면 온도에 적응할 시간을 줍니다.

투명한 소재를 통과해서 측정하는 것은 원칙적으로 불가능합니다.

측정 조건이 안정적이고 우수할수록, 정확하고 신뢰할 만한 결과를 얻을 수 있습니다.

습도 센서 및 주변 온도 센서 (5) 는 화학 유해물질, 예컨대 광택제나 페인트 등의 증기에 의해서 손상될 수 있습니다. 적외선 온도 측정기는 스모그, 증기, 먼지 등의 영향을 받습니다.

따라서 특히 공기가 오염되거나 증기가 많은 경우, 측정 전에 공간을 환기시켜 주십시오. 샤워 직후 욕조 등에서 측정하지 마십시오.

환기 후 잠시 평상시 온도를 되찾을 때까지 온도 적응시간을 두십시오.

주변 온도와 상대 습도는 측정공구의 습도 센서 및 주변 온도 센서 (5) 에서 바로 측정됩니다. 의미 있는 결과를 얻을 수 있도록 측정공구를 난방기 또는 노출되어 있는 액체 등 장애 발생원의 바로 위 혹은 옆에 두지 마십시오. 어떠한 경우에도 센서 (5) 를 덮어두지 마십시오.

반사 표면에서는 적합한 측정 각도에 유의하여 다른 물체에서 반사된 열방출이 결과에 영향을 주지 않도록 하십시오. 예컨대 수직 측정을 진행하는 경우 작업자의 체온 반사로 인해 처음부터 측정을 방해받을 수 있습니다.

#### 줌 레벨 설정하기

디스플레이의 이미지 디테일은 작동 중인 측정에 대해서 그리고 저장된 스크린 샷을 재생할 때 3개의 다양한 줌 레벨(0.5 m, 2 m 및 5 m)로 표시할 수 있습니다.

줌 레벨은 측정공구와 측정 객체 간의 간격에 따라 최적화됩니다. 다시 말해서 측정 간격 2 m에서는 줌 레벨 "2 m" 가 (일반적으로) 최상의 이미지 디테일을 제시합니다.

현재의 줌 레벨은 (d) 표시기에 나타납니다. 줌 레벨을 올릴 때는 줌 레벨 올림 화살표 버튼 (16) 을 누르고, 내릴 때는 줌 레벨 내림 화살표 버튼 (13) 을 누르십시오.

시차(parallax)때문에 선택한 줌 레벨이 실제 측정 간격과 일치할 때만 측정 프레임이 측정 영역 (b) 과 일치합니다.

#### 측정 표면 조명

어두운 영역에서 측정할 때는 화면 표시를 개선하기 위해서 조명 (24) 을 켤 수 있습니다. 이를 통해 스크린샷을 저장할 때 더 좋은 결과를 얻을 수 있습니다.

조명 (24) 을 켜거나 끌 때는 버튼 (14) 을 누르십시오.

디스플레이 밝기가 줄어들면 에너지 절약을 위해 조명은 자동으로 꺼집니다. <항상켜기> 메뉴에서 조명 시간을 변경할 수 있습니다 (참조 „<항상켜기>“, 페이지 48). 디스플레이 조명을 다시 켤 때 조명은 자동으로 켜지지 않습니다.

배터리 충전 상태가 임계 범위에 있으면 에너지 절약 이유에서 조명이 제공되지 않습니다.

#### 측정 기능

##### 개별 모든 간의 전환

오른쪽 화살표 버튼 (11) 또는 왼쪽 화살표 버튼 (15) 으로 원하는 모드를 선택하십시오(짧은 설명과 함께 모드가 표시됨). 설명을 조기에 숨기려면, 저장 버튼 (9) 을 누르십시오. 설명을 숨기고 곧바로 측정을 시작하려면, 버튼 (4) 을 누르십시오.

##### 표면 온도 모드

표면 온도 모드에서는 측정 객체의 표면 온도가 측정됩니다.

이 모드로 가열체를 확인하거나 과열된 기계 부품 등을 찾아낼 수 있습니다.

측정 버튼 (4) 을 눌러 측정을 시작하십시오. 디스플레이에 표시되는 측정값은 계속해서 업데이트됩니다. 측정 버튼 (4) 을 해제하면 곧바로 측정이 중단되고 레이저가 꺼집니다. 디스플레이에는 마지막 측정 결과가 표시기 (n) 에 기록됩니다. 최종 측정된 표면 온도는 마킹 표시 (p) 와 함께 측정 등급 (k) 에 표시됩니다.

측정값의 차이가 3 °C 보다 커지게 되면 곧바로 측정 과정에서 최저 온도값과 최고 온도값이 표시기 (j) 에 나타납니다. 이렇게 해서 현재 측정값이 이미 측정된 온도에 비해 얼마나 높은지 알 수 있습니다.

##### 열교 모드

본 측정공구를 통해 열교를 감지할 수 있습니다 (참조 „열교“, 페이지 49).

측정을 시작하려면 먼저 실외 온도를 설정해야 합니다. 이를 위해 <시작 메뉴> 를 불러오십시오 (참조 „<시작 메뉴>“ 탐색“, 페이지 47). 하위 메뉴 <열교> 를 선택하고 현재 실외 온도를 설정하십시오. 측정 버튼 (4) 을 눌러 측정을 시작하십시오.

실내 주변 온도와 실외 온도를 고려해 표면 온도가 단열에 필요한 최소 요건을 충족하는지 확인됩니다. 최소 요건에 미달될 때는 구조적 결함에서 비롯된 열교에 대해 경고합니다.

측정이 종료되면 최종 목표 대상이었던 측정 객체의 표면 온도가 표시기 (n) 에 그리고 주변 온도가 표시기 (h) 에 기록됩니다. 계산된  $f_{Rsi}$  값 (참조 „열교“, 페이지 49) 과 그 허용 오차 추정치가 표시기 (v) 에 표시됩니다.

측정공구는 마킹 표시 **(p)** 와 함께 값에 대한 분석을 다음과 같이 측정 등급 **(k)** 에 표시합니다:

- 녹색 영역 내 마킹 표시 **(p)** (0.7 위에 있는  $f_{Rsi}$  값, 허용 오차 포함): 열교가 존재하지 않음
- 황색 영역 내 마킹 표시 **(p)** (0.7의 경계 영역 안에 있는  $f_{Rsi}$  값): 측정 영역 안에 열교가 존재할 가능성이 있음. 보다 유리한 환경 조건(예: 더 낮은 실외 온도)에서 다시 측정해야 합니다.
- 적색 영역 내 마킹 표시 **(p)** (0.7 아래에 있는  $f_{Rsi}$  값, 허용 오차 포함): 측정 영역 안에 열교가 존재할 가능성이 높음.

### 이슬점 모드

본 측정기를 사용해 곰팡이 위험이 있는 지점을 발견할 수 있습니다.

이 모드에서 추가로 측정되는 주변 온도와 상대 습도 (참조 „상대 습도“, 페이지 49)로부터 이슬점 온도 (참조 „이슬점 온도“, 페이지 49) 가 계산됩니다. 계산된 이슬점 온도와 측정된 표면 온도의 비교를 통해서 곰팡이 발생 위험이 분석됩니다.

측정 결과는 항상 현재의 환경 조건에 근거한 스냅샷만 제시하고 있음에 유의하십시오. 변화 가능성이 있는 환경 조건에 대해서는 진단이 불가능합니다. 임계 수준의 측정 결과가 도출된 경우, 다른 시간 및 다른 조건에서 측정을 다시 실시하십시오.

측정 버튼 **(4)** 을 눌러 측정을 시작하십시오. 디스플레이에 표시되는 측정값은 계속해서 업데이트됩니다.

측정이 종료되면 최종 목표 대상이었던 측정 객체의 표면 온도가 표시기 **(n)** 에, 주변 온도가 표시기 **(h)** 에 그리고 상대 습도가 표시기 **(g)** 에 기록됩니다. 계산된 이슬점 온도가 **(i)** 에 표시됩니다.

측정공구는 다음과 같이 측정 등급 **(k)** 의 마킹 표시 **(p)** 를 통해 자동으로 값을 분석할 수 있도록 합니다:

- 녹색 영역 내 마킹 표시 **(p)**: 현재 조건에서 곰팡이 발생 위험이 존재하지 않습니다.
- 황색 영역 내 마킹 표시 **(p)**: 측정값이 경계 영역에 있습니다. 실내 온도, 열교 및 습도에 유의하고, 필요한 경우 시간 차이를 두고 측정을 반복하십시오.
- 적색 영역 내 마킹 표시 **(p)**: 습도가 너무 높거나 표면 온도가 이슬점 온도에 가깝기 때문에 곰팡이 발생 위험이 높습니다. 각각 비정상적인 값이 표시기에서 깜박입니다.

표면 온도가 이슬점 온도의 80%에 이르면 곰팡이 발생 위험이 경고됩니다.

**지침:** 본 측정공구는 곰팡이 포자를 찾을 수 없습니다. 단지 변화하지 않는 조건에서 곰팡이 발생 가능성이 있는지를 알려줍니다.

### 접촉 온도 모드

접촉 온도 측정에서는 K 타입의 차폐식 표준 열전대를 사용해 물체의 온도를 직접적으로 측정할 수 있습니다.

접촉 온도 측정은 비접촉 방식의 온도 측정을 여러 가지로 보완할 수 있습니다. 원칙적으로 적외선 측정이 불리한 상황, 예컨대 매체, 액체, 기류 또는 방

사율이 낮은 표면(광택이 있는 금속)의 온도를 측정할 때 의미 있게 사용할 수 있습니다.

특히 액체나 기류, 표면 등 다양한 용도에 맞게 최적화된 센서 형상으로 적합한 센서를 사용할 때 올바른 측정이 가능합니다.

필요한 경우 열전대 제조사의 지침을 참조하십시오. 열전대를 사용하면 원칙적으로 측정 대상에 접촉하게 됩니다. 이때 발생할 수 있는 위험과 안전 지침에 유의하십시오.

이 모드에서는 온도 센서의 온도만 측정되며 다른 측정 변수는 제외됩니다.

**지침:** K 타입의 차폐식 열전대만 사용하십시오. 다른 타입의 열전대를 연결하면 잘못된 측정 결과가 나올 수 있습니다.

커버 **(1)** 를 열고 열전대 제조회사 **(25)** 에 연결하십시오.

열전대가 연결되면 곧바로 표시기 **(n)** 가 디스플레이에 나타납니다. 표시기의 측정값은 계속해서 업데이트됩니다. 이 모드에서는 측정을 위해 측정 버튼 **(4)** 을 누를 필요가 없으며, 레이저는 비활성화됩니다. 신뢰할 수 있는 결과가 도출될 수 있도록 측정값이 더 이상 변하지 않을 때까지 기다리십시오. 열전대 사양에 따라서 수 분이 소요될 수 있습니다. 접촉 온도는 각 작동 모드에서도 표면 온도에 추가해서 측정할 수 있습니다. 그렇게 되면 측정값이 다른 위치에 표시됩니다 **(s)**. 그러나 열교와 곰팡이 위험 탐지에는 항상 표면 온도 **(n)** 가 적용됩니다.

열전대가 제거되면 기능 표시기 **(s)** 가 디스플레이에 나타납니다. 열전대 제거 후에 커버 **(1)** 를 다시 닫으십시오.

### 사용자 모드

사용자 모드에서는 표면 온도와 주변 온도, 상대 습도가 측정됩니다. 이 값으로부터 이슬점 온도 및 평균 온도(측정 과정의 표면 온도 평균값)가 계산됩니다.

필요한 경우 값(평균 온도, 상대 습도, 주변 온도 및 이슬점 온도)을 숨길 수 있습니다.

이 경우 **<시작 메뉴>** 를 불러오십시오 (참조 „**시작 메뉴**“ 탐색“, 페이지 47). 하위 메뉴 **<사용자모드>** 를 선택하십시오. 여기에서 표시기 **<평균온도>**, **<습도>**, **<공간 온도>** 및 **<이슬점>** 를 켜고 끌 수 있습니다.

표면 온도 측정에 대해 측정 등급 **(k)** 의 최소값과 최대값 **(j)** 이 자동으로 조정되거나 또는 수동으로 결정되도록 선택할 수 있습니다. **<사용자모드>** 메뉴에서 하위 메뉴 **<눈금 영역>** 로 이동하십시오.

- 표면 온도 모드처럼 값 **(j)** 이 자동으로 산출되도록 하려면 **<자동>** 을 선택하십시오. 측정값의 차이가 3 °C 보다 커지게 되면 곧바로 측정 과정에서 최저 온도값과 최고 온도값이 표시기 **(j)** 에 나타납니다.

- 값을 수동으로 결정하려면 **<사전 설정됨>** 을 선택하십시오. **<사용자모드>** 메뉴에서 **<하한 눈금>** 및 **<상한 눈금>** 아래에 원하는 값을 설정하십시오. 표시기 **(j)** 에 수동으로 설정한 최소값과 최대값이 나타납니다. 이렇게 하면 서로 다른 측정

의 스크린샷 등을 마킹 표시 (p) 를 기준으로 비교할 수 있습니다.

**표면 온도 경보**

표면 온도 경보는 접촉 온도 측정 외에 모든 모드에서 사용할 수 있습니다. 작업자가 최소 온도 및 최대 온도를 직접 결정할 수 있습니다.

**최저 온도**에 미달될 경우 경보 표시기 (m) 가 청색으로 깜박이고, 신호음이 켜져 있으면 경고 신호가 울립니다.

**최고 온도**에 미달될 경우 온도 경보 표시기 (m) 가 적색으로 깜박이고, 신호음이 켜져 있으면 경고 신호가 울립니다.

표면 온도 경보를 사용하려면 <시작 메뉴> 를 불러오십시오 (참조 „<시작 메뉴> 탐색“, 페이지 47).

- 하위 메뉴 <알람> 를 선택하십시오.
- <알람 최소/최대> 를 <켜짐> 으로 설정하십시오.
- <알람 최소> 아래에 최저 온도를 설정하십시오.
- <알람 최대> 아래에 최고 온도를 설정하십시오.

<꺼짐> 의 경보를 설정하면 최소 온도 및 최대 온도가 저장됩니다.

**데이터 전송**

**측정 결과 저장/표시/전송**

측정이 종료되면 측정 결과를 저장하기 위한 저장 기호가 디스플레이 표시기에 나타납니다. 저장/전송 버튼 (9) 을 누르십시오.

측정 결과가 JPG 형식(고정 디스플레이의 스크린샷)으로 저장됩니다.



- 저장된 스크린샷을 표시하려면 갤러리 기호 (q) 아래에 있는 왼쪽 기능 버튼 (17) 을 누르십시오. 마지막으로 저장된 사진이 디스플레이에 나타납니다.

- 저장된 스크린샷을 앞뒤로 전환하려면 오른쪽 화살표 버튼 (11) 또는 왼쪽 화살표 버튼 (15) 을 누르십시오.

- 표시된 측정 결과를 블루투스®를 통해 전송하려면 저장 버튼/전송 버튼 (9) 을 누르십시오. 블루투스® 연결이 아직 켜지지 않은 경우 (참조 „블루투스®를 통한 데이터 전송“, 페이지 46), 저장 버튼/전송 버튼을 통해서 활성화됩니다.



- 표시된 스크린샷을 삭제하려면, 휴지통 기호 아래에 있는 오른쪽 기능 버튼 (10) 을 누르십시오.



- 삭제 단계를 승인하려면, 체크 기호 아래에 있는 왼쪽 기능 버튼 (17) 을 누르십시오.



- 삭제 단계를 취소하려면, 십자 기호 아래에 있는 오른쪽 기능 버튼 (10) 을 누르십시오.



- 갤러리 보기에서 나가 측정 모드로 돌아가려면, 뒤로 가기 기호 아래에 있

는 왼쪽 기능 버튼 (17) 을 누르십시오.

저장된 모든 데이터를 한번에 삭제할 수도 있습니다 (참조 „<모든이미지 삭제>“, 페이지 48).

**USB 포트를 통한 데이터 전송**

마이크로 USB 포트의 커버를 제거하십시오 (1). 함께 제공되는 마이크로 USB 케이블 (8) 을 통해 측정공구의 마이크로 USB 포트 (26) 와 컴퓨터를 연결하십시오.

이제 전원 버튼 (12) 을 눌러 측정공구를 켜십시오. 컴퓨터에서 데이터 브라우저를 열고 GIS 1000 C 드라이브를 선택하십시오. 저장된 데이터는 측정공구의 내부 메모리에서 복사해 컴퓨터로 옮기거나 삭제할 수 있습니다.

원하는 작업이 종료되면 컴퓨터에서 드라이브를 정상적으로 분리한 뒤 전원 버튼 (12) 을 눌러 측정공구를 끄십시오.

**주의:** 반드시 운영 시스템에서 먼저 드라이브 연결을 끊어야 합니다(드라이브 분리). 그렇지 않은 경우 측정공구의 내부 메모리가 손상될 수 있습니다. 측정 작동 도중에는 마이크로 USB 케이블을 분리하고, 커버 (1) 를 닫아 두십시오.

하우징 안으로 먼지나 물기가 들어가지 않도록 USB 포트 커버를 항상 닫아 두십시오.

**지침:** 측정공구는 USB를 통해 컴퓨터에만 연결하십시오. 다른 장치에 연결할 경우 측정공구가 손상될 수 있습니다.

**블루투스®를 통한 데이터 전송**

측정공구에는 블루투스® 모듈이 탑재되어 있으며, 모바일 단말기로 측정공구의 데이터를 무선 전송할 수 있습니다. 이 기능을 사용할 수 있도록 전문적인 보쉬 애플리케이션(앱)이 제공됩니다. 단말기에 따라 해당 스토어에서 다운로드할 수 있습니다.



보쉬 애플리케이션을 통해 (무선 데이터 전송 외에) 확장된 기능 서비스를 사용하고, 측정 후 작업들을 간편하게 진행하며, 측정 데이터를 이메일 등으로 전송할 수 있습니다. 블루투스® 연결에 필요한 시스템 관련 정보는 보쉬 인터넷 사이트 [www.bosch-professional.com/thermal](http://www.bosch-professional.com/thermal)에서 확인할 수 있습니다.

측정공구의 블루투스® 연결을 켜려면 <시작 메뉴> 를 불러오고 (참조 „<시작 메뉴> 탐색“, 페이지 47) 의 <블루투스> 를 <켜짐> 으로 설정하십시오. 디스플레이에 표시기 (e) 가 나타납니다. 모바일 단말기에 있는 블루투스® 인터페이스가 활성화되었는지 확인하십시오.

보쉬 애플리케이션을 시작하면 (블루투스® 모듈이 활성화된 상태에서) 모바일 단말기와 측정공구가 연결됩니다. 활성화된 여러 개의 측정공구 중에 적합한 것을 고르십시오. 활성화된 측정공구가 하나만 발견되면, 자동으로 연결 구성이 이뤄집니다.

**지침:** 측정공구와 모바일 단말기(예: 스마트 폰, 태블릿)의 연결이 처음이라면 측정공구의 핀코드를 물어볼 수도 있습니다. 이때는 "0000"을 입력하십시오.

블루투스®를 이용하여 데이터를 전송할 경우 수신 조건이 좋지 않아 모바일 단말기와 측정공구 간에 시간 지연이 있을 수 있습니다.

## <시작 메뉴>

### <시작 메뉴> 탐색



- <시작 메뉴> 로 이동하려면 기본 표시 화면에서 메뉴 기호 (I) 아래에 있는 오른쪽 기능 버튼 (10) 을 누르십시오.

- 메뉴 안에서 탐색할 때는 왼쪽 화살표 버튼 (16) 및 아래쪽 화살표 버튼 (13) 을 원하는 메뉴 항목이 컬러로 하이лай트 표시될 때까지 누르십시오.



- 하이лай트 표시된 메뉴 항목에 하위 메뉴가 있을 경우 <설정> 옆에 오른쪽 방향 화살표가 나타납니다. 하위 메뉴로 이동하려면 오른쪽 화살표 버튼 (11) 을 누르십시오.



- 하이лай트 표시된 메뉴 항목에 여러 선택 기능이 있다면, 현재 설정이 2개의 화살표 사이에 표시됩니다. 설정을 변경하려면 왼쪽 화살표 버튼 (15) 또는 오른쪽 화살표 버튼 (11) 을 누르십시오. 해당 화살표 버튼을 계속 누르고 있으면 숫자값이 더 빨리 변경됩니다.

- 일부 메뉴 항목의 경우 기능을 켜거나 끌 수 있습니다. 끌 때는 왼쪽 화살표 버튼 (15) 을 누르면 <꺼짐 > 가 하이лай트로 표시됩니다. 켤 때는 오른쪽 화살표 버튼 (11) 을 누르면 <켜짐> 이 하이лай트로 표시됩니다. 저장 버튼/전송 버튼 (9) 으로도 메뉴 기능을 켜고 끌 수 있습니다.



- 상위 메뉴로 이동하려면 뒤로 가기 기호 아래에 있는 왼쪽 기능 버튼 (17) 을 누르십시오. 선택한 설정이 저장됩니다.



- <시작 메뉴> 에서 벗어나 기본 표시 화면으로 되돌아가려면 홈 기호 아래에 있는 오른쪽 기능 버튼 (10) 을 누르십시오. 선택한 설정이 저장됩니다.



- 모든 메뉴에서 벗어나 기본 표시 화면으로 되돌아가려면 측정 버튼 (4) 을 눌러도 됩니다. 버튼을 한 번 누르면

선택한 설정이 저장되지만 측정은 활성화되지 않습니다.

## 측정 하위 메뉴

### <방사율> (t)

자주 측정하는 소재의 경우 저장된 방사율을 선택할 수 있습니다. 간편 검색을 위해 방사율 목록과 그룹 만들기로 값을 관리할 수 있습니다. <소재> 메뉴 항목에서 먼저 적합한 카테고리 및 적합한 소재를 선택합니다. 해당 방사율이 아래에 표시됩니다. 측정 객체의 정확한 방사율을 알고 있을 경우, <방사율> 메뉴 항목에서 숫자값으로도 설정할 수 있습니다. 동일한 소재들을 자주 측정하는 경우, 5개의 방사율을 즐겨찾기로 저장한 뒤 윗줄(1부터 5까지)에서 빠르게 불러올 수 있습니다.

### <반사 온도> (t)

이 매개 변수를 설정하면 특히 방사율이 낮은(= 반사도가 높은) 소재에서 측정 결과가 개선됩니다. 대부분의 경우 (특히 실내에서) 반사 온도는 주변 온도와 일치합니다. 측정 객체 주변에 방사율이 높은 개체가 있고 온도 차이가 커서 측정에 영향을 줄 수 있는 경우, 이 값을 조정해야 합니다.

## 하위 메뉴 <장치>

<시작 메뉴> 를 불러온 후 하위 메뉴 <장치> 를 선택하십시오. 다음의 메뉴 항목이 포함되어 있습니다.

### <언어>

<언어> 메뉴에서 모든 표시기의 언어를 변경할 수 있습니다.

### <시간 & 날짜>

표시기의 시간 및 날짜 (a) 를 변경하려면, 하위 메뉴 <시간 & 날짜> 를 불러오십시오. 그 외에도 이 항목에서는 시간 형식 및 날짜 형식을 변경할 수 있습니다.

하위 메뉴 <시간 & 날짜> 에서 벗어나려면, 왼쪽 기능 버튼 (17) 을 눌러 설정 내역을 저장하거나 오른쪽 기능 버튼 (10) 을 눌러 변경을 취소하십시오.

### <단위>

메뉴 <단위> 에서 온도 단위 <°C> 또는 <°F> 를 선택할 수 있습니다.

### <레이저>

하위 메뉴 <레이저> 에서 측정기의 레이저를 켜거나 끌 수 있습니다. 레이저는 측정 표면의 경계를 구분하므로 예외적인 경우에만 비활성화해야 합니다.

### <프레임>

<프레임> 메뉴에서 디스플레이의 측정 프레임 (b) 을 켜거나 끌 수 있습니다.

### <색상설정>

<색상설정> 메뉴에서 디스플레이의 온도값 및 다른 표시기의 색상을 선택할 수 있습니다. 설정은 저장된 스크린샷에도 적용됩니다.

### <자동 꺼짐 시간>

메뉴 <자동 꺼짐 시간> 에서 버튼 누름이 없을 때 측정공구가 자동으로 꺼지는 시간 간격을 선택할 수 있습니다. 설정 <끄지않기 > 을 선택해 자동 꺼짐을 비활성화할 수도 있습니다. 스위치 오프 간격을 짧게 설정할수록 에너지가 더 절약됩니다.

**<항상켜기>**

**<항상켜기>** 메뉴에서 측정공구의 버튼을 누르지 않을 때 디스플레이 밝기가 줄어드는 시간 간격을 선택할 수 있습니다. 설정 **<항상>** 을 선택해 디스플레이 조명을 계속 켜진 상태로 둘 수도 있습니다. 조명 지속 시간을 짧게 설정할수록 에너지가 더 절약됩니다.

**<신호음>**

**<신호음>** 메뉴에서 표면 온도 경보 시 울리는 신호음을 켜거나 끌 수 있습니다.

**<모든이미지 삭제>**

**<모든이미지 삭제>** 메뉴에서 내부 메모리에 있는 모든 데이터를 한번에 삭제할 수 있습니다. 하위 메뉴로 이동하려면, **<더보기>** 의 오른쪽 화살표 버튼 **(11)** 을 누르십시오. 오른쪽 기능 버튼 **(10)** 을 누르십시오. 오른쪽 기능 버튼 **(10)** 을

눌러 모든 데이터를 삭제하거나 왼쪽 기능 버튼 **(17)** 을 눌러 작업을 중단하십시오.







**<장치 정보>**

측정공구에 관한 정보는 하위 메뉴 **<장치 정보>** 를 불러오십시오. 측정공구의 일련 번호와 설치된 소프트웨어 버전을 확인할 수 있습니다.

**<초기 설정>**

이 메뉴 항목에서는 측정공구를 초기 설정으로 리셋하고 모든 데이터를 영구적으로 삭제할 수 있습니다. 이 경우 상황에 따라 수 분의 소요될 수 있습니다. 하위 메뉴로 이동하려면, **<더보기>** 의 오른쪽 화살표 버튼 **(11)** 을 누르십시오. 오른쪽 기능 버튼 **(10)** 을 눌러 모든 데이터를 삭제하거나 왼쪽 기능 버튼 **(17)** 을 눌러 작업을 중단하십시오.

**고장 - 원인 및 대책**

고장	원인	해결 방법
 측정공구가 켜지지 않습니다.	충전용 배터리 및 배터리 부족	충전용 배터리를 충전하거나 배터리를 교체하십시오.
 배터리 온도가 너무 높거나 낮음	화상 메모리 결함	배터리의 열을 식히거나 배터리를 교체하십시오.
 화상 메모리 결함	화상 메모리 부족	모든 이미지를 삭제하고 내부 메모리를 포맷하십시오 (참조 „<모든이미지 삭제>“, 페이지 48). 문제가 계속될 경우 측정공구를 보쉬의 공인 서비스 센터에 맡기십시오.
 측정공구 결함	측정공구 결함	필요한 경우 이미지를 다른 저장 매체(컴퓨터 또는 노트북)로 옮기십시오. 그리고 나서 내부 메모리의 이미지를 삭제하십시오.
 접착 온도 측정용 기능 표시기 (s)가 디스플레이에 나타나지 않습니다.	열전대 커넥터 (25) 또는 열전대에 문제가 있습니다	측정공구를 보쉬의 공인 서비스 센터에 맡기십시오.
측정공구와 컴퓨터가 연결되지 않습니다.	컴퓨터가 측정공구를 인식하지 못합니다.	컴퓨터 드라이버의 업데이트를 확인하십시오. 경우에 따라 컴퓨터 운영 시스템 업데이트가 필요합니다.
 마이크로 USB 단자 또는 마이크로 USB 케이블 결함	마이크로 USB 단자 또는 마이크로 USB 케이블 결함	측정공구가 다른 컴퓨터와 연결되는지 확인하십시오. 연결되지 않는다면 측정공구를 보쉬의 공인 서비스 센터에 맡기십시오.
 습도 센서 및 주변 온도 센서 (5) 결함	습도 센서 및 주변 온도 센서 (5) 결함	측정공구의 다른 기능은 계속 사용할 수 있습니다. 측정공구를 보쉬의 공인 서비스 센터에 맡기십시오.

**개념 설명**

**적외선 열방출**

적외선 열방출은 켈빈 온도 0 (-273 °C)를 초과하는 모든 물체에서 나오는 전자기파입니다. 방출량은 물체의 온도 및 방사율에 따라 다릅니다.

**방사율**

측정 객체의 방사율은 소재와 그 표면의 구조에 따라 달라집니다. 측정 객체가 방출하는 적외선 열방출을 이상적인 열방출 물체(흑체, 방사율  $\epsilon = 1$ )와

비교해서 0부터 1까지의 값으로 나타내는 것입니다.

**반사 온도 / 측정 객체의 반사도**

반사 온도는 측정 객체 자체에서 나오지 않는 열방출입니다. 구조와 소재에 따라서 주변 방출이 측정 객체에서 반사되어 원래의 온도 결과에 영향을 줍니다.



**열교**

열교란 건물 외벽에서 설계상 부분적으로 열 손실이 증가된 지점을 말합니다.

열교를 평가할 때는 DIN 4108-2에 따른 단열의 최소 요건을 적용할 수 있습니다.

$f_{Rsi}$  온도 계수가 **0.7**보다 클 경우 DIN 4108-2에 따른 단열의 최소 요건이 준수됩니다.

$f_{Rsi}$  온도 계수 계산:

$$f_{Rsi} = \frac{T_1 - T_2}{T_3 - T_2}$$

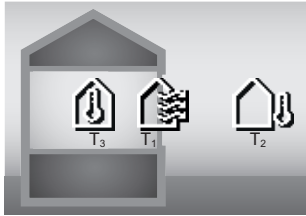

T<sub>1</sub>: 실내 표면 온도  
T<sub>2</sub>: 실외 온도  
T<sub>3</sub>: 실내 주변 온도

최소 단열은 곰팡이 방지를 위한 한계 기준입니다. 이에 따라 건축 구조상의 위험 요소를 방지할 수 있습니다.

기준 조건(실외 온도 -5 °C, 실내 주변 온도 20 °C)에서 표면 온도가 12.6 °C 아래로 내려가면 안 됩니다. 이것은  $f_{Rsi}$  한계값 0.7에 해당됩니다. 최대한의 미 있는 결과(오차 낮음)를 얻기 위해서는 실외 온도가 10 °C 미만이어야 합니다.

**상대 습도**

상대 습도는 공기 중에 수증기가 포화된 정도를 말합니다. 공기가 흡수할 수 있는 최대 수증기량을 퍼센트 값으로 표시합니다. 최대 수증기량은 온도에 따라 달라집니다. 다시 말해 온도가 높아지면 공기 가 더 많은 수증기를 흡수할 수 있습니다.

상대 습도가 너무 높을 경우 곰팡이 위험이 증가합니다. 습도가 너무 낮으면 건강에 좋지 않을 수 있습니다.

**이슬점 온도**

이슬점 온도는 공기에 포함된 수증기가 응결되기 시작하는 온도를 말합니다. 이슬점 온도는 상대 습도 및 기온에 따라 달라집니다.

표면 온도가 이슬점 온도보다 낮으면 표면의 수분이 응결되기 시작합니다.

표면 응결수는 곰팡이 발생의 주요 원인입니다.

**보수 정비 및 서비스**

**보수 정비 및 유지**

항상 측정공구를 깨끗이 유지하십시오. 오염물이 묻은 적외선 수신 렌즈 (23) 는 측정 정확도에 문제가 생길 수 있습니다.

오염된 부위는 마른 부드러운 천으로 깨끗이 닦으십시오. 세척제 또는 용제를 사용하지 마십시오.

청소할 때 액체가 측정공구 안으로 들어가지 않도록 하십시오.

특히 습도 센서 및 온도 센서 (5), 카메라 (22), 수신 렌즈 (23), 조명 (24) 및 레이저 발사구 (2) 를 매우 주의 깊게 청소하십시오. 카메라, 수신 렌즈 또는 레이저 발사구에 보푸라기가 없어야 합니다. 카메라, 수신 렌즈 및 레이저 발사구는 사진기 렌즈에 적합한 도구로만 닦으십시오. 뾰족한 물건으로 센서, 카메라 또는 수신 렌즈에 있는 먼지를 제거하려 하지 말고, 카메라 및 수신 렌즈 위쪽으로 닦아내지 마십시오 (스크래치 위험).

습도 범위 30~50 % 밖의 공간에 장시간 측정공구를 두지 마십시오. 습도가 너무 높거나 낮은 곳에 측정공구를 두면 첫 작동 시 측정 오류가 발생할 수 있습니다.

습도 센서는 원칙적으로 응해제, 접착제 및 유연제에 민감하게 반응합니다. 이런 물질에 계속해서 영향을 받으면 측정된 습도에 편차가 발생할 수 있습니다.

측정기를 비닐 백에 보관하지 마십시오. 비닐 백에서 발생하는 증기로 인해서 습도 센서 및 온도 센서 (5) 가 손상될 수도 있습니다. 측정공구 센서 주변에 스티커를 부착하지 마십시오.

측정공구를 새로 보정할 때는 보쉬의 공인 서비스 센터에 맡기십시오.

반드시 측정공구를 함께 공급된 안전 케이스에 넣어 보관하고 운반하십시오.

수리 시 측정공구를 보호 가방에 넣어서 보내 주십시오.

**AS 센터 및 사용 문의**

AS 센터에서는 귀하 제품의 수리 및 보수정비, 그리고 부품에 관한 문의를 받고 있습니다. 대체 부품에 관한 분해 조립도 및 정보는 인터넷에서도 찾아볼 수 있습니다 - [www.bosch-pt.com](http://www.bosch-pt.com)

보쉬 사용 문의 팀에서는 보쉬의 제품 및 해당 액세서리에 관한 질문에 기꺼이 답변 드릴 것입니다.

문의나 대체 부품 주문 시에는 반드시 제품 내임 플랫폼에 있는 10자리의 부품번호를 알려 주십시오.

콜센터  
080-955-0909

다른 AS 센터 주소는 아래 사이트에서 확인할 수 있습니다:

[www.bosch-pt.com/serviceaddresses](http://www.bosch-pt.com/serviceaddresses)

**운반**

포함되어 있는 리튬이온 배터리는 위험물 관련 규정을 따라야 합니다. 별도의 요구사항 없이 배터리를 사용자가 직접 도로 상에서 운반할 수 있습니다.

제3자를 통해 운반할 경우 (항공 운송이나 운송 회사 등) 포장과 표기에 관한 특별한 요구 사항을 준수해야 합니다. 이 경우 발송 준비를 위해 위험물 전문가와 상담해야 합니다.

표면이 손상되지 않은 배터리만 사용하십시오. 배터리의 접촉 단자면을 덮어 붙인 상태로 내부에서 움직이지 않도록 배터리를 포장하십시오. 또한 이와 관련한 국내 규정을 준수하십시오.

## 처리



측정공구, 충전용 배터리/배터리, 액세서리 및 포장은 친환경적으로 재활용됩니다.



측정공구 및 충전용 배터리/배터리를 가정용 쓰레기에 버리지 마십시오!

## 오직 EU 국가에만 해당:

더이상 사용할 수 없는 측정공구 및 결함이 있거나 사용한 충전용 배터리/배터리는 유럽 가이드라인 2012/19/EU 및 유럽 가이드라인 2006/66/EC에 따라 분리 수거하여 환경 규정에 맞춰 재활용해야 합니다.

## 충전용 배터리/배터리:

### 리튬이온:

운반 단락에 나와 있는 지침을 참고하십시오 (참조 „운반“, 페이지 49)을 누르십시오.

## ไทย

## กฎระเบียบเพื่อความปลอดภัย



ส่งเครื่องมือวัดให้ช่างผู้เชี่ยวชาญตรวจสอบและไขอะไหล่เปลี่ยนของแท่นั้น หากไม่ใช่เครื่องมือวัดตามคำแนะนำเหล่านี้ระบบป้องกันเบ็ดเสร็จในเครื่องมือวัดอาจได้รับผลกระทบ อย่าทำให้ป้ายเตือนที่อยู่บนเครื่องมือวัดนี้ลบเลือน เก็บรักษาคำแนะนำเหล่านี้ไว้ให้ดี และหากเครื่องมือวัดนี้ถูกส่งต่อไปยังผู้อื่น ให้ส่งมอบคำแนะนำเหล่านี้ไปด้วย

- ▶ **ข้อควรระวัง** - การใช้อุปกรณ์ทำงานหรืออุปกรณ์ปรับเปลี่ยนอื่นๆ นอกเหนือไปจากที่ระบุไว้ในที่นี่ หรือการใช้วิธีการอื่นๆ อาจนำไปสู่การสัมผัสกับรังสีอันตรายได้
- ▶ เครื่องมือวัดนี้จัดส่งมาพร้อมป้ายเตือนแสงเลเซอร์ (แสดงในหน้าภาพประกอบของเครื่องมือวัด)
- ▶ หากข้อความของป้ายเตือนแสงเลเซอร์ไม่ได้เป็นภาษาของท่าน ให้ติดสติ๊กเกอร์ที่จัดส่งมาที่พิมพ์เป็นภาษาของท่านทับลงบนข้อความก่อนใช้งานครั้งแรก



อย่าส่องลำแสงเลเซอร์ไปยังคนหรือสัตว์ และตัวท่านเองอย่าจ้องมองเข้าไปในลำแสงเลเซอร์โดยตรงหรือลำแสงเลเซอร์สะท้อน การกระทำดังกล่าวอาจทำให้คนตาพร่า ทำให้เกิดอุบัติเหตุ หรือทำให้ดวงตาเสียหายได้

- ▶ ถ้าแสงเลเซอร์เข้าตา ต้องปิดตาและหันศีรษะออกจากลำแสงในทันที
- ▶ อย่าทำการเปลี่ยนแปลงใดๆ ที่อุปกรณ์เลเซอร์

- ▶ **อย่าใช้แว่นสำหรับมองแสงเลเซอร์ (อุปกรณ์เสริม) เป็นแว่นนิรภัย** แว่นสำหรับมองแสงเลเซอร์ใช้สำหรับมองลำแสงเลเซอร์ให้เห็นชัดเจนยิ่งขึ้น แต่ไม่ได้ช่วยป้องกันรังสีเลเซอร์
- ▶ **อย่าใช้แว่นสำหรับมองแสงเลเซอร์ (อุปกรณ์เสริม) เป็นแว่นกันแดดหรือใส่ซันรยนต์** แว่นสำหรับมองแสงเลเซอร์ไม่สามารถป้องกันรังสีอัลตราไวโอเล็ต (UV) ได้ อย่างสมบูรณ์ และยังลดความสามารถในการมองเห็นสี
- ▶ **ส่งเครื่องมือวัดให้ช่างผู้เชี่ยวชาญตรวจสอบและไขอะไหล่เปลี่ยนของแท่นั้น** ทั้งนี้เพื่อให้มั่นใจได้ว่าจะสามารถใช้งานเครื่องมือวัดได้อย่างปลอดภัยเสมอ
- ▶ **อย่าให้เด็กใช้เครื่องมือวัดด้วยเลเซอร์โดยไม่ควบคุมดูแล** เด็กๆ อาจทำให้บุคคลอื่นหรือตนเองตาพร่าโดยไม่ตั้งใจ
- ▶ **อย่าใช้เครื่องมือวัดในสภาพแวดล้อมที่เสี่ยงต่อการระเบิด** ซึ่งเป็นที่ที่มีของเหลว แก๊ส หรือฝุ่นที่ติดไฟได้ในเครื่องมือวัดสามารถเกิดประกายไฟซึ่งอาจจุดฝุ่นละอองหรือไอระเหยให้ติดไฟได้
- ▶ **อย่าเปิดแบตเตอรี่** อันตรายจากการลัดวงจร
- ▶ **เมื่อแบตเตอรี่ชาร์จและนำไปใช้งานอย่างไม่ถูกต้อง** อาจมีไอระเหยออกมาได้ แบตเตอรี่อาจเผาไหม้หรือระเบิดได้ให้สูดอากาศบริสุทธิ์และไปพบแพทย์ในกรณีเจ็บปวด ไอระเหยอาจทำให้ระบบหายใจระคายเคือง
- ▶ **หากไขอย่างไม่ถูกต้องหรือหากแบตเตอรี่ชาร์จของเหลวไหลออกมาจากแบตเตอรี่ได้** หลีกเลี่ยงการสัมผัสของเหลว ในกรณีนี้สัมผัสโดยไม่ตั้งใจให้ล้างออกด้วยน้ำ หากของเหลวเข้าตา ให้ไปพบแพทย์ด้วยของเหลวที่ไหลออกมาจากแบตเตอรี่อาจทำให้เกิดอาการคันหรือแสบผิวหนังได้
- ▶ **วัตถุที่แหลมคม ต. ย. เช่น ตะปูหรือไขควง หรือแรงกระแทกภายนอก** อาจทำให้แบตเตอรี่เสียหายได้ สิ่งเหล่านี้นี้อาจทำให้เกิดการลัดวงจรภายในและแบตเตอรี่ใหม่ มีควัน ระเบิด หรือร้อนเกินไป
- ▶ **นำแบตเตอรี่ที่ไม่ได้ใช้งานออกห่างจากคลิป์หนีบกระดาษ เหรียญ กุญแจ ตะปู สกรู หรือวัตถุโลหะขนาดเล็กอื่นๆ** ที่สามารถเชื่อมต่อขั้วหนึ่งไปยังอีกขั้วหนึ่งได้ การลัดวงจรของขั้วแบตเตอรี่อาจทำให้เกิดการไหม้หรือไฟลุกได้
- ▶ **ใช้แบตเตอรี่แพ็คเกจเฉพาะ** ในผลิตภัณฑ์ของผู้ผลิตเท่านั้น ในลักษณะนี้ แบตเตอรี่แพ็คเกจได้รับการปกป้องจากการใช้งานเกินกำลังซึ่งเป็นอันตราย
- ▶ **ชาร์จแบตเตอรี่แพ็คเกจด้วยเครื่องชาร์จที่บริษัทผู้ผลิตแนะนำเท่านั้น**

เครื่องชาร์จที่เหมาะสมสำหรับชาร์จแบตเตอรี่ประเภทหนึ่ง หากนำไปชาร์จแบตเตอรี่ประเภทอื่น อาจเกิดไฟไหม้ได้



**ปกป้องแบตเตอรี่จากความร้อน รวมทั้ง ต. ย.**



**เช่น จากการถูกแสงแดดส่องต่อเนื่อง จากไฟ  
สิ่งสกปรก น้ำ และความชื้น อันตรายจากการ  
ระเบิดและการลัดวงจร**

- ▶ **ถอดแบตเตอรี่แพ็คหรือแบตเตอรี่ออกจากเครื่องมือวัด  
ก่อนทำการปรับแต่งใดๆ ที่เครื่องมือวัด (ต. ย. เช่น  
การติดตั้ง การบำรุงรักษา ฯลฯ) และระหว่างการขน  
ย้ายและการเก็บรักษา อันตรายจากการได้รับบาดเจ็บ  
หากสวิตช์เปิด-ปิดถูกกดโดยไม่เจตนา**
- ▶ **ระวัง! การใช้เครื่องมือไฟฟ้าที่มี Bluetooth® อาจ  
รบกวนอุปกรณ์และเครื่องมืออื่น ๆ เครื่องบิน และ  
อุปกรณ์ทางการแพทย์ (ต. ย. เช่น เครื่องกระตุ้นหัวใจ เครื่อง  
ช่วยฟัง) นอกจากนี้ยังอาจเกิดความเสียหายต่อคนและ  
สัตว์ในบริเวณใกล้เคียงด้วย อย่าใช้เครื่องมือวัดที่มี  
Bluetooth® ใกล้เคียง อุปกรณ์ทางการแพทย์ สถานี  
บริการน้ำมัน โรงงานเคมี พื้นที่ที่เสี่ยงต่อการระเบิด  
และในพื้นที่ทำการระเบิด อย่าใช้เครื่องมือไฟฟ้าที่มี  
Bluetooth® ในเครื่องบิน หลีกเลี่ยงการใช้งานเป็น  
ระยะเวลานานตรงบริเวณใกล้ร่างกายโดยตรง**

เครื่องหมายข้อความ Bluetooth® และยังเป็น  
เครื่องหมายการค้าจดทะเบียนและเป็นกรรมสิทธิ์ของ  
Bluetooth SIG, Inc. บริษัท Robert Bosch Power  
Tools GmbH ได้รับใบอนุญาตใช้งานเครื่องหมาย  
ข้อความ/โลโก้ดังกล่าว

- ▶ **ป้องกันเครื่องมือวัดโดยเฉพาะบริเวณที่มีความชื้นใน  
อากาศ อุณหภูมิแวดล้อม และเซ็นเซอร์อินฟราเรดจาก  
ความชื้นที่สะสมให้พ้นจากฝุ่นและสิ่งสกปรก เลนส์รับอาจ  
เกิดฝ้าหรือสกปรกและผลการวัดอาจผิดเพี้ยนได้ การตั้ง  
ค่าเครื่องมืออย่างไม่ถูกต้องตลอดจนปัจจัยอื่นๆ ที่มีอิทธิพล  
ต่อบรรยากาศอาจทำให้การวัดผิดเพี้ยนได้ วัดดูอาจแสดง  
อุณหภูมิสูงหรือต่ำเกินไปได้ ซึ่งอาจเป็นอันตรายเมื่อสัมผัส**
- ▶ **คุณสามารถวัดอุณหภูมิได้อย่างถูกต้องหากค่า  
สัมประสิทธิ์การแผ่รังสีความร้อนที่ตั้งไว้สอดคล้องกับ  
ค่าสัมประสิทธิ์การแผ่รังสีความร้อนของวัตถุ และตั้ง  
อุณหภูมิสะท้อนที่ถูกต้อง วัดดูอาจแสดงอุณหภูมิสูงหรือ  
ต่ำเกินไปได้ ซึ่งอาจเป็นอันตรายเมื่อสัมผัส**

### คำแนะนำเพื่อความปลอดภัยเมื่อใช้เทอร์โม คัปเปิล

- ▶ **ห้ามใช้เทอร์โมคัปเปิลระบบไฟฟ้าที่มีแรงดันไฟฟ้า มี  
อันตรายถึงชีวิต!**

- ▶ **การใช้เทอร์โมคัปเปิลทำให้มีการสัมผัสกับวัตถุ** ดังนั้น  
ควรระวังอันตรายที่อาจเกิดขึ้นจากอุณหภูมิแรงดันไฟฟ้า  
หรือปฏิกิริยาทางเคมี

## รายละเอียดผลิตภัณฑ์และข้อมูล จำเพาะ

กรุณาดูภาพประกอบในส่วนหน้าของคู่มือการใช้งาน

### ประโยชน์การใช้งานของเครื่อง

เครื่องมือวัดนี้ใช้สำหรับวัดอุณหภูมิพื้นผิวโดยไม่ต้องสัมผัส  
อุณหภูมิแวดล้อม และความชื้นในอากาศ ค่าอุณหภูมิ  
จุดน้ำค้างและระบุสะพานความร้อนและความเสี่ยงในเกิดเชื้อ  
รา ไม่สามารถตรวจจับสปอร์ของเชื้อราได้ด้วยเครื่องมือวัด  
อย่างไรก็ตาม สามารถระบุเงื่อนไขตั้งต้นซึ่งส่งผลต่อการ  
เจริญเติบโตของเชื้อราได้

อย่าใช้อุปกรณ์วัดนี้สำหรับวัดอุณหภูมิที่คนและสัตว์ หรือเพื่อ  
วัตถุประสงค์ทางการแพทย์อื่นๆ อย่างเด็ดขาด

เครื่องมือวัดนี้ไม่เหมาะสำหรับใช้วัดอุณหภูมิพื้นผิวของก๊าซ  
สามารถวัดอุณหภูมิในของเหลวได้ด้วยเทอร์โมคัปเปิลที่มี  
จำหน่ายทั่วไป (ประเภทพอร์ต K) ซึ่งสามารถเชื่อมต่อกับ  
เครื่องมือวัดผ่านทางอินเทอร์เฟซ (25) ที่จัดมาให้ได้  
สามารถวัดอุณหภูมิพื้นผิวได้ใช้เทอร์โมคัปเปิลสัมผัสพื้นผิว  
แสงจากเครื่องมือวัดนี้ใช้ส่งไปยังพื้นที่ทำงานโดยตรงของ  
เครื่องมือวัดสำหรับการถ่ายภาพ  
ห้ามใช้จุดเลเซอร์เป็นตัวชี้เลเซอร์ ใช้เพื่อทำเครื่องหมายบน  
พื้นผิวการวัดเท่านั้น

เครื่องมือวัดนี้เหมาะสำหรับใช้งานทั้งภายในและภายนอก  
อาคาร

### ส่วนประกอบที่แสดงภาพ

ลำดับเลขของส่วนประกอบอ้างอิงถึงส่วนประกอบของเครื่องมือ  
วัดที่แสดงในหน้าภาพประกอบ

- (1) ฝาครอบช่องเสียบไมโคร USB / พอร์ตเทอร์โม  
คัปเปิล (ประเภท K)
- (2) ช่องทางออกลำแสงเลเซอร์
- (3) แป้นปลดล็อคแบตเตอรี่แพ็ค/แบตเตอรี่อะแดปเตอร์/  
ฝาช่องใส่แบตเตอรี่
- (4) ปุ่มวัด/ปุ่มลัด
- (5) ความชื้นในอากาศและเซ็นเซอร์อุณหภูมิแวดล้อม
- (6) หมายเลขเครื่อง
- (7) ป้ายเตือนแสงเลเซอร์
- (8) สายไมโคร USB

- (9) ปุ่มบันทึก/ปุ่มส่ง (Bluetooth®)
- (10) ปุ่มฟังก์ชันทางขวา
- (11) ปุ่มลูกศรขวา
- (12) ปุ่มเปิด/ปิด
- (13) ปุ่มลูกศรชี้ขึ้น/ลดระดับการขยาย
- (14) ปุ่มเปิด/ปิดไฟส่องสว่าง
- (15) ปุ่มลูกศรด้านซ้าย
- (16) เพิ่มปุ่มลูกศร/ระดับการขยาย
- (17) ปุ่มฟังก์ชันทางซ้าย
- (18) จอแสดงผล
- (19) ฝาปิดป้องกันความชื้นในอากาศและเซ็นเซอร์อุณหภูมิแวดล้อม
- (20) หุกล้อสายหัว
- (21) ฝาปิดป้องกันเลนส์รับอินฟราเรด
- (22) กล้องถ่ายรูป
- (23) เลนส์รับรังสีอินฟราเรด
- (24) ไฟส่องสว่าง
- (25) ประเภทพอร์ต K สำหรับเทอร์โมคัปเปิล
- (26) พอร์ตไมโคร USB
- (27) บล็อกหุ้มแบตเตอรี่อะแดปเตอร์<sup>a)</sup>
- (28) ฝาปิดแบตเตอรี่อะแดปเตอร์<sup>a)</sup>
- (29) ช่องแบตเตอรี่
- (30) แบตเตอรี่แพ็ค<sup>a)</sup>
- (31) ฝาช่องใส่แบตเตอรี่<sup>a)</sup>

a) อุปกรณ์ประกอบที่แสดงภาพหรืออธิบายไม่รวมอยู่ในการจัดส่งมาตรฐาน  
กรุณาดูอุปกรณ์ประกอบทั้งหมดในรายการแสดงอุปกรณ์ประกอบของเรา

#### องค์ประกอบของการแสดงผล (ดูภาพประกอบ A)

- (a) วันที่/เวลา (ดู "<Time & Date> (เวลา & วันที่)", หน้า 61)
- (b) กรอบการวัด (ดู "การวัดพื้นผิวสำหรับการวัดอุณหภูมิพื้นผิว", หน้า 56)

#### ข้อมูลทางเทคนิค

เครื่องตรวจจับความร้อน	GIS 1000 C	GIS 1000 C
หมายเลขสินค้า	3 601 K83 3..	3 601 K83 371

#### (c) โฟนแสดงสถานะ:



เครื่องมือวัดพร้อมสำหรับการวัด ให้อัดปุ่มวัด (4)



กำลังดำเนินการวัด (อย่างต่อเนื่อง) การวัดแสงเลเซอร์เปิดใช้งานอยู่



การวัดเสร็จสิ้นแล้ว เลเซอร์จะปิดการทำงาน ผลการวัดได้รับการแก้ไขแล้ว



โหมดอุณหภูมิพื้นผิวเลเซอร์จะปิดใช้งาน การวัดจะทำงานในเทอร์โมคัปเปิลเท่านั้น

- (d) หน้าจอแสดงผลระดับการขยาย (ดู "ปรับระดับการขยาย", หน้า 57)
- (e) หน้าจอแสดงผล Bluetooth® เปิดสว่างอยู่ (ดู "การถ่ายโอนข้อมูลผ่าน Bluetooth®", หน้า 60)
- (f) โฟนแสดงสถานะการชาร์จ
- (g) หน้าจอแสดงผลฟังก์ชัน/ค่าวัดความชื้นสัมพัทธ์
- (h) โฟนแสดงฟังก์ชัน/ค่าวัดอุณหภูมิแวดล้อม
- (i) โฟนแสดงฟังก์ชัน/ผลลัพธ์อุณหภูมิจุดน้ำค้าง
- (j) ค่าวัดอุณหภูมิพื้นผิวต่ำสุด/สูงสุดในระหว่างกระบวนการวัด
- (k) สเกลผลลัพธ์
- (l) ไอคอนเมนู
- (m) หน้าจอแสดงผลสัญญาณเตือนอุณหภูมิพื้นผิว (ดู "สัญญาณเตือนอุณหภูมิพื้นผิว", หน้า 59)
- (n) ค่าจากการวัด
- (o) โหมดปัจจุบัน
- (p) การทำเครื่องหมายค่าวัดหรือผลลัพธ์ (ขึ้นอยู่กับโหมดที่เลือก)
- (q) ไอคอนแกลลอรี่
- (r) โฟนแสดงฟังก์ชัน/ค่าวัดอุณหภูมิเฉลี่ย
- (s) โฟนแสดงฟังก์ชัน/ค่าวัดอุณหภูมิสัมพัทธ์
- (t) หน้าจอแสดงผลค่าสัมประสิทธิ์การแผ่รังสีความร้อน/อุณหภูมิที่สะท้อน
- (u) ตั้งอุณหภูมิภายนอก (โหมดสะพานความร้อน)
- (v) หน้าจอแสดงผลค่า  $f_{RS}$  พร้อมค่าเพื่อ (โหมดสะพานความร้อน)

เครื่องตรวจจับความร้อน	GIS 1000 C	GIS 1000 C
ช่วงการใช้งาน	0.1-5 ม.	0.1-5 ม.
ขอบเขตการวัด		
- อุณหภูมิพื้นผิว	-40 ... +1000 °C	-40 ... +1000 °C
- อุณหภูมิสัมผัส	-40 ... +1000 °C	-40 ... +1000 °C
- อุณหภูมิแวดล้อม	-10 ... +50 °C	-10 ... +50 °C
- ค่าวัดความชื้นสัมพัทธ์	0 ... 100 %	0 ... 100 %
<b>ความแม่นยำการวัด<sup>A)</sup></b>		
<b>อุณหภูมิพื้นผิว<sup>B)</sup></b>		
-40 ... -20.1 °C	±2.5 °C	±2.5 °C
-20 ... -0.1 °C	±1.5 °C	±1.5 °C
<b>0 ... +100 °C</b>	<b>±1 °C</b>	<b>±1 °C</b>
+100 °C ... +400 °C	±1 %	±1 %
> +400 °C	±2 %	±2 %
<b>อุณหภูมิแวดล้อม</b>	±1 °C	±1 °C
<b>ค่าวัดความชื้นสัมพัทธ์<sup>C)</sup></b>		
< 20 %	±3 %	±3 %
<b>20 ... 60 %</b>	<b>±2 %</b>	<b>±2 %</b>
60 ... 90 %	±3 %	±3 %
แสง (อัตราส่วนระยะทางวัด: จุดวัด) <sup>D)E)</sup>	50 : 1	50 : 1
ระดับเลเซอร์	2	2
ชนิดเลเซอร์	635 นาโนเมตร, < 1 มิลลิวัตต์	635 นาโนเมตร, < 1 มิลลิวัตต์
การบานออกของลำแสง (มุมเต็ม)	< 1.5 mrad	< 1.5 mrad
ความสูงใช้งานเหนือระดับอ้างอิง สูงสุด	2000 ม.	2000 ม.
ระดับมลพิษตาม IEC 61010-1	2 <sup>F)</sup>	2 <sup>F)</sup>
ค่าวัดความชื้นสัมพัทธ์สูงสุด	90 %	90 %
แบตเตอรี่ (อัลคาไลน์-แมงกานีส)	4 × 1.5 V LIR6 (AA) (มีแบตเตอรี่อะแดปเตอร์)	4 × 1.5 V LIR6 (AA)
แบตเตอรี่แพ็ค (ลิเทียม-ไอออน)	10.8 V/12 V	-
ระยะเวลาทำงาน		
- แบตเตอรี่ (อัลคาไลน์-แมงกานีส)	3 ชม.	3 ชม.
- แบตเตอรี่แพ็ค (ลิเทียม-ไอออน) <sup>G)</sup>	10 ชม.	-
จำนวนภาพในหน่วยความจำภายใน	> 200	> 200
Bluetooth® (Classic และ Low Energy)	4.2 <sup>H)</sup>	4.2 <sup>H)</sup>
ย่านความถี่ใช้งาน	2402-2480 เมกะเฮิรตซ์	2402-2480 เมกะเฮิรตซ์

เครื่องตรวจจับความร้อน	GIS 1000 C	GIS 1000 C
กำลังส่ง สูงสุด	2.5 มิลลิวัตต์	2.5 มิลลิวัตต์
พอร์ต USB	2.0	2.0
น้ำหนักตามระเบียบการ EPTA-Procedure 01:2014 <sup>(3)</sup>	0.56–0.77 กก.	0.51 กก.
ขนาด (ยาว x กว้าง x สูง)	136 × 89 × 214 มม.	136 × 89 × 214 มม.
สภาวะแวดล้อม		
- อุณหภูมิโดยรอบที่แนะนำเมื่อชาร์จ	0°C ... +35°C	-
- อุณหภูมิโดยรอบที่อนุญาตเมื่อใช้งาน	-10°C ... +50°C	-10°C ... +50°C
- อุณหภูมิโดยรอบที่อนุญาตเมื่อเก็บรักษาโดยไม่มีแบตเตอรี่	-20°C ... +70°C	-20°C ... +70°C
- อุณหภูมิโดยรอบที่อนุญาตเมื่อเก็บรักษาโดยมีแบตเตอรี่	-20°C ... +50°C	-
แบตเตอรี่ที่แนะนำ	GBA 10,8V... GBA 12V...	-
เครื่องชาร์จที่แนะนำ	GAL 12...	-

- A) บวกค่าความลาดเคลื่อนซึ่งขึ้นอยู่กับการใช้งาน (เช่น การสะท้อน ระยะทาง อุณหภูมิแวดล้อม)  
 B) ที่อุณหภูมิแวดล้อม +20 °C ... +23 °C, ค่าการแผ่รังสี > 0.999, ระยะการวัด 0.3 ม., รูรับแสง 60 มม.  
 C) ที่อุณหภูมิแวดล้อม +15 °C ... +40 °C  
 D) ข้อมูลตาม VDI/VDE 3511 หน้า 4.3 (วันออกเผยแพร่ กรกฎาคม 2005); ไขกับ 90 % ของสัญญาณวัด ความเบี่ยงเบนของผลการวัดสามารถเกิดขึ้นได้ในทุกช่วงที่เกินขนาดที่ระบุไว้ในข้อมูลทางเทคนิค  
 E) หมายถึงการวัดด้วยอินฟราเรด ดูภาพ::

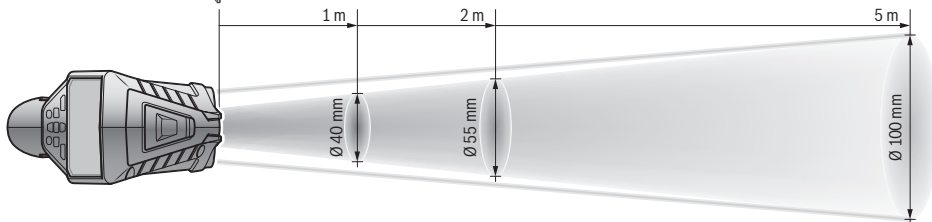

- F) เกิดขึ้นเฉพาะมลพิษที่ไม่นำไฟฟ้า ยกเว้นบางครั้งนำไฟฟ้าได้ชั่วคราวที่มีสาเหตุจากการลั่นตัวที่ได้คาดว่าจะเป็น  
 G) ขึ้นอยู่กับแบตเตอรี่แพ็คที่ใช้  
 H) สำหรับอุปกรณ์ Bluetooth® Low Energy อาจไม่มีการเชื่อมต่อ ทั้งนี้ขึ้นอยู่กับรุ่นและระบบปฏิบัติการ อุปกรณ์ Bluetooth® ต้องรองรับการทำงานแบบพรอดูมกรม (SPP)

หมายเลขเครื่อง (6) บนแผ่นป้ายรุ่นนี้ไว้เพื่อระบุเครื่องมือวัดของคุณ

## การติดตั้ง

### แหล่งจ่ายพลังงาน เครื่องมือวัด

เครื่องมือวัดสามารถทำงานกับแบตเตอรี่มาตรฐานที่วางจำหน่ายทั่วไป หรือแบตเตอรี่แพ็คลิเทียม ไอออน ของ บ๊อช หมายเลขสินค้า **3 601 K83 371**: เครื่องมือวัดสามารถทำงานกับแบตเตอรี่มาตรฐานเท่านั้น

### การทำงานกับแบตเตอรี่ (ไม่ใช่สำหรับหมายเลขสินค้า 3 601 K83 371) (ดูภาพประกอบ B)

ต้องใส่แบตเตอรี่เข้าในแบตเตอรี่อะแดปเตอร์

- ▶ แบตเตอรี่อะแดปเตอร์นี้มีไว้สำหรับใช้ในเครื่องมือวัด บ๊อช ที่ออกแบบมาให้ใช้ได้เท่านั้น และต้องนำมาใช้งานกับเครื่องมือไฟฟ้า

เมื่อต้องการใส่แบตเตอรี่ ให้เลื่อนปลอกหุ้ม (27) ของแบตเตอรี่อะแดปเตอร์เข้าในช่องแบตเตอรี่ (29) ใต้

แบตเตอรี่เข้าไปในปลอกหุ้มตามภาพประกอบบนฝาปิด (28) เลื่อนฝาปิดเข้าบนปลอกหุ้มจนเข้าล็อกอย่างเห็นได้ชัด



เมื่อต้องการถอดแบตเตอรี่ ให้กดปุ่มปลดล็อก (3) ของฝาปิด (28) และดึงฝาปิดออก ระวังอย่าให้แบตเตอรี่ร่วงหล่นออกมา ให้ถือเครื่องวัดโดยหันช่องแบตเตอรี่ (29) ขึ้น ด้านบน ถอดแบตเตอรี่ออก เมื่อต้องการถอดปลอกหุ้มที่อยู่ ด้านใน (27) ออกจากช่องแบตเตอรี่ ให้จับเข้าไปในปลอกหุ้ม และดึงออกจากเครื่องมือวัด โดยยกบนผนังด้านข้างเล็กน้อย เปลี่ยนแบตเตอรี่ทุกอันพร้อมกันเสมอ โดยใช้แบตเตอรี่จากผู้ผลิตรายเดียวกันทั้งหมดและมีความจุเท่ากันทุกอัน

▶ **เมื่อไม่ใช้งานเครื่องมือวัดเป็นเวลานาน ต้องถอดแบตเตอรี่ออก** แบตเตอรี่ในเครื่องมือวัดอาจกักความร้อนในระหว่างเก็บรักษาเป็นเวลานาน และปล่อยประจุออกเองได้

**การทำงานกับแบตเตอรี่ (ไม่ใช่สำหรับหมายเลขสินค้า 3 601 K83 371) (ดูภาพประกอบ C)**

▶ **ใช้เฉพาะเครื่องชาร์จแบตเตอรี่ที่ระบุไว้ในข้อมูลทางเทคนิคนี้เท่านั้น** เฉพาะเครื่องชาร์จแบตเตอรี่เหล่านี้เท่านั้น ที่ถูกออกแบบมาให้ใช้ได้กับแบตเตอรี่แพ็คลิเทียม ไอออนที่ใช้ในเครื่องมือวัดของท่าน

**หมายเหตุ:** การใช้แบตเตอรี่แพ็คที่ไม่เหมาะสมสำหรับเครื่องมือวัดอาจทำให้เครื่องทำงานผิดปกติหรือเกิดความเสียหายได้

**หมายเหตุ:** แบตเตอรี่ที่จัดส่งมาถูกชาร์จมาแล้วบางส่วน เพื่อให้แน่ใจว่าแบตเตอรี่จะทำงานได้อย่างสมบูรณ์แบบ ให้ชาร์จแบตเตอรี่จนเต็มก่อนใช้งานครั้งแรก

แบตเตอรี่ลิเทียม ไอออน

สามารถชาร์จได้ตลอดเวลาโดยอายุการใช้งานจะไม่ลดลง การขัดจังหวะกระบวนการชาร์จไม่ทำให้แบตเตอรี่เสียหาย

สำหรับใส่แบตเตอรี่แพ็คที่ชาร์จแล้ว (30) ให้เลื่อนแบตเตอรี่แพ็คเข้าไปในช่องแบตเตอรี่ (29) จนเข้าล็อกอย่างเห็นได้ชัด

สำหรับถอด แบตเตอรี่แพ็ค (30) ให้กดปุ่มปลดล็อก (3) และดึงแบตเตอรี่แพ็คออกจากช่องแบตเตอรี่ (29) **อย่าใช้กำลังดึง**

**การทำงานกับแบตเตอรี่ (3 601 K83 371) (ดูภาพประกอบ D)**

เปิดฝาช่องใส่แบตเตอรี่ (31) โดยกดปุ่มปลดล็อก (3) และถอดฝาช่องใส่แบตเตอรี่ออก

ขณะใส่แบตเตอรี่ต้องดูให้ขั้วแบตเตอรี่อยู่ในตำแหน่งที่ถูกต้องตามภาพประกอบบนฝาช่องใส่แบตเตอรี่

ใส่ฝาช่องใส่แบตเตอรี่ (31) เข้าอีกครั้งและให้ล็อกเข้าจนสัมพันธ์ได้

เปลี่ยนแบตเตอรี่ทุกอันพร้อมกันเสมอ โดยใช้แบตเตอรี่จากผู้ผลิตรายเดียวกันทั้งหมดและมีความจุเท่ากันทุกอัน

▶ **เมื่อไม่ใช้งานเครื่องมือวัดเป็นเวลานาน ต้องถอดแบตเตอรี่ออก** แบตเตอรี่ในเครื่องมือวัดอาจกักความร้อนในระหว่างเก็บรักษาเป็นเวลานาน และปล่อยประจุออกเองได้

## การปฏิบัติงาน

### การเริ่มต้นปฏิบัติงาน

▶ **ป้องกันไม่ให้เครื่องมือวัดได้รับ ความชื้นและโดนแสงแดดส่องโดยตรง**

▶ **อย่าให้เครื่องมือวัดได้รับอุณหภูมิที่สูงมาก หรือรับอุณหภูมิที่เปลี่ยนแปลงมาก** ต.ย. เช่น อย่าปล่อยให้เครื่องมือวัดอยู่ในรถยนต์เป็นเวลานานในกรณีที่อุณหภูมิมีการเปลี่ยนแปลงมาก ต้องปล่อยให้เครื่องมือวัดปรับตัวเข้ากับอุณหภูมิรอบด้านก่อนใช้งาน อุณหภูมิที่สูงมากหรืออุณหภูมิต่ำที่เปลี่ยนแปลงมากอาจส่งผลต่อความแม่นยำของเครื่องมือวัด

▶ **เอาใจใส่ให้เครื่องมือวัดปรับตัวเข้ากับสภาพอากาศอย่างถูกต้อง** หากอุณหภูมิมีความผันผวนมาก ระยะเวลาปรับตัวให้เข้ากับสภาพอากาศอาจนานถึง 60 นาที อาจเกิดกรณีนี้ได้ เช่น หากคุณเก็บเครื่องมือวัดไว้ในรถที่เย็นแล้ว และวัดในอาคารที่อบอุ่น

▶ **อย่าให้เครื่องมือวัดถูกกระแทกอย่างรุนแรงหรืออย่าให้ตกหล่น** หลังได้รับการกระทบจากภายนอกอย่างรุนแรง และเมื่อพบความผิดปกติในการทำงาน ท่านควรส่งเครื่องมือวัดไปตรวจสอบที่ศูนย์บริการลูกค้า **Bosch** ที่ได้รับมอบหมาย

### การเปิด-ปิดเครื่อง

ถอดฝาครอบป้องกัน (21) ออกจากเลนส์ตัวรับอินฟราเรด (23) และฝาครอบป้องกัน (19) ออกจากเซ็นเซอร์วัดความชื้นในอากาศและเซ็นเซอร์อุณหภูมิแวดล้อม (5) **ในขณะที่ท่านตรวจสอบให้แน่ใจว่ากล้อง (22) เลนส์รับ (23) และเซ็นเซอร์ (5) ไม่ล็อกหรือปิดอยู่ มิฉะนั้นจะไม่สามารถดำเนินการวัดได้อย่างถูกต้อง**

**เปิดสวิตช์** เครื่องมือวัดโดยกดปุ่มเปิด-ปิด (12) หรือปุ่มวัด (4) บนจอแสดงผล (18) ปราบกฏลำดับการหยุด ทุกครั้งเมื่อเปิดสวิตช์ เครื่องมือวัดจะอยู่ในโหมดการทำงานที่บันทึกไว้ล่าสุด เลเซอร์ยังไม่เปิดสวิตช์

หลังจากลำดับเริ่มต้นเมนู <Tool> (เครื่องมือ) ซึ่งคุณสามารถตั้งค่าสำหรับเครื่องมือวัดได้ เช่น ตั้งค่าภาษาของการแสดงผลทั้งหมด (ดู "เมนูย่อย <Tool> (เครื่องมือ)", หน้า 61) ยืนยันการตั้งค่าที่เลือกโดยกดปุ่มฟังก์ชันด้านขวา (10) สามารถเปลี่ยนแปลงการตั้งค่าทั้งหมดได้ในภายหลังได้ในเมนูย่อย <Tool> (เครื่องมือ)

► **อย่าวางเครื่องมือวัดที่เปิดสวิตช์ทิ้งไว้โดยไม่มีผู้ดูแล และปิดสวิตช์เครื่องมือวัดเมื่อเลิกใช้งาน** คนอื่นอาจตาพร่าจากแสงเลเซอร์ได้

► **อย่าส่องลำแสงเลเซอร์ไปยังคนหรือสัตว์ และอย่าจ้องมองลำแสงเลเซอร์แม้จะอยู่ในระยะไกล**

ในการตั้งค่าจากโรงงาน ความสว่างของหน้าจอแสดงผลจะลดลง 30 วินาที หลังจากกดปุ่มแต่ละครั้ง เพื่อประหยัดพลังงาน เมื่อคุณกดปุ่มใด ๆ หน้าจอแสดงผลจะเปิดขึ้นอีกครั้งโดยสว่างอย่างเต็มที่ ในเมนู **<Light Duration> (ระยะเวลาส่องสว่าง)** คุณสามารถเปลี่ยนระยะเวลาของความสว่าง (ดู **<Light Duration> (ระยะเวลาส่องสว่าง)**", หน้า 61) นี้ได้

**ปิดสวิตช์เครื่องมือวัด** โดยกดปุ่มเปิด/ปิด (12) เครื่องมือวัดบันทึกโหมดการทำงานปัจจุบันและการตั้งค่าทั้งหมด จากนั้นจึงปิดสวิตช์เครื่อง ใส่ฝาครอบป้องกัน (21) เข้าที่เลนส์ตัวรับอินฟราเรด (23) และฝาครอบป้องกัน (19) อีกครั้งเข้าที่เซ็นเซอร์วัดความชื้นในอากาศและเซ็นเซอร์อุณหภูมิแวดล้อม (5)

อย่าปิดเครื่องมือวัดโดยถอดแบตเตอรี่แพคหรืออะแดปเตอร์แบตเตอรี่ออก เพราะอาจทำให้หน่วยความจำภายในเสียหายได้

ในเมนูหลัก คุณสามารถตั้งค่าว่าจะปิดสวิตช์เครื่องมือวัดปิดโดยอัตโนมัติหรือไม่และปิดสวิตช์หลังจากเวลาใด โดยไม่ต้องกดปุ่มใดๆหรือไม่ต้องทำการวัด (ดู **<Shutdown Time> (เวลาปิดสวิตช์)**", หน้า 61) หากมีการปิดสวิตช์โดยอัตโนมัติ โหมดการทำงานปัจจุบันและการตั้งค่าจะถูกบันทึกไว้

หากแบตเตอรี่หรือเครื่องมือวัดอยู่นอกอุณหภูมิการทำงานที่ระบุไว้ในข้อมูลทางเทคนิค เครื่องมือวัดจะปิดโดยอัตโนมัติหลังจากมีค่าเตือนสั้นๆ (ดู "ข้อผิดพลาด - สาเหตุและมาตรการแก้ไข", หน้า 62) ปรากฏขึ้น ปล่อยให้เครื่องมือวัดเย็นลงแล้วเปิดสวิตช์ใหม่อีกครั้ง

## การเตรียมการวัด

### ตั้งค่าการแผ่รังสีสำหรับการวัดอุณหภูมิพื้นผิว

สำหรับการกำหนดอุณหภูมิพื้นผิว เราจะวัดการแผ่รังสีความร้อนอินฟราเรดตามธรรมชาติที่ปล่อยออกมาจากวัตถุเป้าหมาย ซึ่งเป็นการวัดแบบไม่สัมผัส เพื่อให้ได้การวัดที่ถูกต้องต้องตรวจสอบค่าสัมประสิทธิ์การแผ่รังสีความร้อนที่ตั้งไว้ที่เครื่องมือวัดก่อนการวัดทุกครั้ง และปรับให้เข้ากับวัตถุที่วัด หากจำเป็น

ค่าสัมประสิทธิ์การแผ่รังสีความร้อนที่ตั้งไว้ล่วงหน้าในเครื่องมือวัดเป็นค่านี้

ท่านสามารถเลือกค่าสัมประสิทธิ์การแผ่รังสีความร้อนที่ตั้งไว้ล่วงหน้าค่าใดค่าหนึ่ง หรือป้อนค่าตัวเลขที่แน่นอน ตั้งค่า

สัมประสิทธิ์การแผ่รังสีความร้อนที่ต้องการในเมนู

**<Measurement> (การวัด) → <Emissivity value> (ค่าสัมประสิทธิ์การแผ่รังสี) เมนู (ดู **<Main Menu> (เมนูหลัก)**", หน้า 60)**

► **คุณสามารถวัดอุณหภูมิได้อย่างถูกต้องหากค่าสัมประสิทธิ์การแผ่รังสีความร้อนที่ตั้งไว้สอดคล้องกับค่าสัมประสิทธิ์การแผ่รังสีความร้อนของวัตถุ และตั้งอุณหภูมิสะท้อนที่ถูกต้อง** วัตถุอาจแสดงอุณหภูมิสูงหรือต่ำเกินไปได้ ซึ่งอาจเป็นอันตรายเมื่อสัมผัส

ยิ่งค่าสัมประสิทธิ์การแผ่รังสีความร้อนต่ำลงเท่าใด อิทธิพลของอุณหภูมิสะท้อนที่มีต่อผลการวัดก็จะมากขึ้นเท่านั้น ดังนั้นหากคุณเปลี่ยนการแผ่รังสีให้ปรับอุณหภูมิสะท้อนเสมอ ตั้งค่าอุณหภูมิสะท้อนผ่านเมนู **<Measurement> (การวัด) → <Reflected Temp.> (อุณหภูมิสะท้อน)** (ดู **<Main Menu> (เมนูหลัก)**", หน้า 60)

หากมีวัตถุหลายชิ้นที่มีค่าสัมประสิทธิ์การแผ่รังสีความร้อนต่างกันภายในพื้นที่วัดที่ทำเครื่องหมายด้วยเลเซอร์ อาจส่งผลให้การวัดอุณหภูมิอาจเป็นเท็จ

### การวัดพื้นผิวสำหรับการวัดอุณหภูมิพื้นผิว

จุดเลเซอร์ที่เครื่องมือวัดสร้างขึ้นจะแบ่งพื้นที่การวัดเป็นวงกลมออกด้านนอก อุณหภูมิที่แสดงค่าแสดงอุณหภูมิพื้นผิวเฉลี่ยภายในบริเวณนี้

► **อย่าส่องลำแสงเลเซอร์ไปยังคนหรือสัตว์ และอย่าจ้องมองลำแสงเลเซอร์แม้จะอยู่ในระยะไกล**

ระยะห่างระหว่างจุดเลเซอร์และขนาดของพื้นที่วัดจะเพิ่มขึ้นตามระยะห่างระหว่างเครื่องมือวัดและวัตถุที่วัด

หากจุดเลเซอร์มองเห็นได้ยากคุณสามารถเปิด

**<Measuring Frame> (กรอบการวัด) (b)** บนจอแสดงผลได้ (ดู **<Measuring Frame> (กรอบการวัด)**", หน้า 61)

กรอบการวัดสามารถใช้เป็นตัวบ่งชี้สำหรับพื้นที่การวัดและใช้เพื่อเป็นแนวทางในการวัด กรอบการวัดอาจเบี่ยงเบนไปจากพื้นผิวการวัดได้ ทั้งนี้ขึ้นอยู่กับระยะการวัด พื้นที่ระหว่างจุดเลเซอร์เป็นตัวกำหนดสำหรับการวัด

### ข้อสังเกตเกี่ยวกับเงื่อนไขการวัด

พื้นผิวที่มีการสะท้อนแสง เงาไม้ หรือโปร่งใส (เช่น กระจกเบื้องเงา พื้นผิวที่ด้านหน้าเป็นสแตนเลสสตีล หรือหม้อหุงต้ม) สามารถส่งผลกระทบต่ออุณหภูมิพื้นผิว หากจำเป็น ให้ใช้เทปกาวยาสีเข้มแบบด้านที่นำความร้อนได้ดีไปปิดทับพื้นผิวที่จะวัด ปล่อยให้เทปปรับตัวให้เข้ากับอุณหภูมิมบนพื้นผิวสักพัก

เนื่องจากตามหลักการที่เกี่ยวข้อง ไม่สามารถวัดค่าผ่านวัสดุโปร่งใสได้

ยังมีเงื่อนไขการวัดที่ดีกว่าและเสถียรกว่า ยิ่งได้ผลการวัดที่ถูกต้องและน่าเชื่อถือยิ่งขึ้น



เซ็นเซอร์วัดความชื้นในอากาศและอุณหภูมิแวดล้อม (5) อาจเสียหายได้ หากสัมผัสกับมลพิษทางเคมี เช่น ไอระเหยจากสารเคลือบเงาหรือสี การวัดอุณหภูมิด้วยอินฟราเรดอาจได้รับผลกระทบจากควัน ไอน้ำ หรืออากาศที่เต็มไปด้วยฝุ่น ดังนั้นให้ระบยาอากาศในห้องก่อนทำการวัด โดยเฉพาะอย่างยิ่งเมื่ออากาศสกปรกหรือเต็มไปด้วยไอน้ำ อย่าทำการวัด ต.ย. เช่น ในห้องน้ำทันทีหลังจากอาบน้ำ

หลังจากระบายอากาศแล้ว ปล่อยให้ห้องปรับตัวให้เข้ากับอากาศสักพักจนกว่าห้องจะกลับสู่อุณหภูมิปกติอีกครั้ง อุณหภูมิแวดล้อมและค่าวัดความชื้นสัมพัทธ์จะวัดเช่น เซอร์วิท ความชื้นในอากาศและอุณหภูมิแวดล้อม (5) ที่เครื่องมือวัดโดยตรง เพื่อให้ได้ผลลัพธ์ที่แม่นยำ ดำเนินการวัดอยู่เหนือหรือติดกับแหล่งกำเนิดสัญญาณรบกวน เช่น เครื่องทำความร้อนหรือของเหลวที่เปิดอยู่ ห้ามให้เซ็นเซอร์ (5) ถูกบดบัง

เมื่อพื้นผิวมีการสะท้อนแสง ให้หามุมวัดที่ดี เพื่อที่ว่าความแตกต่างจากความร้อนจากวัตถุอื่นๆ จะไม่ปิดบังเหมือนผลจากการวัด ตัวอย่างเช่น เมื่อวัดตามแนวตั้งจากด้านบน การสะท้อนของความร้อนในร่างกายของคุณเองอาจรบกวนการวัด

### ปรับระดับการขยาย

ส่วนภาพในจอแสดงผลสามารถแสดงในระดับการขยายที่แตกต่างกัน 3 ระดับสำหรับการวัดต่อเนื่อง และเมื่อเล่นภาพหน้าจอที่บันทึกไว้: 0.5 ม., 2 ม. และ 5 ม.

ระดับการขยายได้รับการปรับให้เหมาะสมกับระยะห่างที่สอดคล้องกันระหว่างเครื่องมือวัดและวัตถุที่วัด: ที่ระยะการวัด 2 ม. ระดับการขยาย "2 ม." จะแสดงส่วนภาพที่ดีที่สุด (โดยทั่วไป)

ระดับการขยายปัจจุบันจะปรากฏในจอแสดงผล (d) ในการเพิ่มระดับการขยาย ให้กดปุ่มลูกศรเพิ่มระดับการขยาย (16) หากต้องการลดระดับการขยายให้กดปุ่มลูกศรลดระดับการขยาย (13)

เนื่องจากพารัลแลกซ์รบกวนการวัด (b) จะตรงกับช่วงการวัดเท่านั้นหากระดับการขยายที่เลือกสอดคล้องกับระยะการวัดจริง

### ส่องให้พื้นที่การวัดสว่าง

เมื่อทำการวัดในพื้นที่มืดคุณสามารถเปิดไฟส่องสว่าง (24) เพื่อปรับปรุงการมองเห็นของหน้าจอให้ชัดเจน วิธีนี้ช่วยให้คุณได้ผลลัพธ์ที่ดีขึ้นเมื่อบันทึกภาพหน้าจอ

ปิด/เปิดสวิทช์ไฟส่องสว่าง (24) โดยกดปุ่ม (14)

เพื่อประหยัดพลังงาน หลอดไฟจะปิดโดยอัตโนมัติเมื่อความสว่างของหน้าจอแสดงผลลดลง ในเมนู <Light Duration> (ระยะเวลาส่องสว่าง) คุณสามารถเปลี่ยนระยะเวลาของความสว่าง (ดู <Light Duration> (ระยะเวลาส่องสว่าง))", หน้า 61) นี้ได้ เมื่อหน้าจอแสดงผลเปิดขึ้นอีกครั้ง ไฟจะไม่เปิดโดยอัตโนมัติ

เวลาส่องสว่าง)", หน้า 61) นี้ได้ เมื่อหน้าจอแสดงผลเปิดขึ้นอีกครั้ง ไฟจะไม่เปิดโดยอัตโนมัติ

หากระดับการชาร์จของแบตเตอรี่อยู่ในช่วงวิกฤต จะไม่สามารถใช้ไฟส่องสว่างเพื่อประหยัดพลังงานได้

### ฟังก์ชันการวัด

#### สลับระหว่างแต่ละโหมด

ใช้ปุ่มลูกศรขวา (11) หรือซ้าย (15) เพื่อเลือกโหมดที่ต้องการ (โหมดนี้จะแสดงพร้อมคำอธิบายโดยย่อ) ต้องการซ่อนคำอธิบายก่อนกำหนดให้กดปุ่มบันทึก (9) หากต้องการซ่อนคำอธิบายและเริ่มการวัดทันที ให้กดปุ่มวัด (4)

#### โหมดอุณหภูมิพื้นผิว

ในโหมดอุณหภูมิพื้นผิว จะทำการวัดอุณหภูมิพื้นผิววัตถุที่ต้องการวัด

ในโหมดนี้ คุณสามารถ ตรวจสอบ เช่น ตรวจสอบหม้อน้ำ หรือค้นหาชิ้นส่วนเครื่องจักรที่ร้อนเกินไป

กดปุ่มสำหรับการวัด (4) เพื่อเริ่มต้นการวัด ค่าวัดที่แสดงในหน้าจอจะอัปเดตอย่างต่อเนื่อง ทันทีที่ปล่อยนิ้วจากปุ่มวัด (4) การวัดจะถูกขัดจังหวะ ไฟแสดงจะดับลง และแสงเลเซอร์จะปิด ในหน้าจอแสดงผล ผลการวัดล่าสุดได้รับการแก้ไขในการแสดงผล (n) ค่าอุณหภูมิพื้นผิวที่วัดได้ล่าสุด จะแสดงพร้อมกับเครื่องหมาย (p) จะปรากฏขึ้นบนสเกล (k)

ค่าอุณหภูมิต่ำสุดและสูงสุดของกระบวนการวัดจะปรากฏบนหน้าจอแสดงผล (j) ทันทีที่ความแตกต่างระหว่างค่าวัดมากกว่า 3 °C ช่วยให้คุณสามารถทราบว่าคุณวัดในปัจจัยสูงเพียงใดเมื่อเทียบกับอุณหภูมิที่วัดได้แล้ว

#### โหมดสะพานความร้อน

เครื่องมือวัดสามารถช่วยคุณค้นหาสะพานความร้อน (ดู "สะพานความร้อน", หน้า 63) ได้

ก่อนที่จะเริ่มการวัดได้ต้องตั้งอุณหภูมิภายนอกก่อน เปิด

<Main Menu> (เมนูหลัก) เป็น (ดู <Main Menu> (เมนูหลัก)", หน้า 60) เลือกเมนู

ย่อย <Thermal Bridge> (สะพานความร้อน) และตั้งค่าอุณหภูมิภายนอกปัจจุบัน กดปุ่มสำหรับการวัด (4) เพื่อเริ่มต้นการวัด

อุณหภูมิภายในและภายนอกเป็นตัวกำหนดว่า อุณหภูมิพื้นผิวเป็นไปตามเงื่อนไขขั้นต่ำสำหรับจนกว่าความร้อนหรือไม่ หากไม่เป็นไปตามข้อกำหนดขั้นต่ำ ถือว่ามีข้อบกพร่องของโครงสร้างและจะมีค่าเตือนเกี่ยวกับสะพานความร้อน

หลังจากการวัดเสร็จสิ้น อุณหภูมิพื้นผิวของวัตถุที่วัดล่าสุดจะปรากฏขึ้นบนหน้าจอแสดงผล (n) และอุณหภูมิแวดล้อมจะปรากฏขึ้นอย่างถาวรบนหน้าจอแสดงผล (h) ค่า  $f_{RSI}$  ที่คำนวณได้ (ดู "สะพานความร้อน", หน้า 63) และค่าเพื่อโดยประมาณจะแสดงบนหน้าจอแสดงผล (v)

เครื่องมือวัด ระบุการตีความค่าให้เห็นเป็นเครื่องหมาย (p) บนสเกลผลลัพธ์ (k):

- เครื่องหมาย (p) ในบริเวณสีเขียว (ค่า  $f_{Rsi}$  สูงกว่า 0.7, รวมถึงค่าเพื่อ): ไม่มีสะพานความร้อน
- เครื่องหมาย (p) ในบริเวณสีเหลือง (ค่า  $f_{Rsi}$  ในบริเวณจำกัด 0.7): อาจมีสะพานความร้อนในบริเวณที่วัด ควรทำการวัดซ้ำภายใต้สภาพแวดล้อมที่เอื้ออำนวยมากกว่า (เช่น เมื่ออุณหภูมิภายนอกต่ำลง)
- เครื่องหมาย (p) ในบริเวณสีแดง (ค่า  $f_{Rsi}$  ต่ำกว่า 0.7, รวมถึงค่าเพื่อ): อาจมีสะพานความร้อนในบริเวณที่วัด

### โทษจุดน้ำค้าง

เครื่องมือวัดสามารถช่วยคุณตรวจหาบริเวณที่เสี่ยงต่อการก่อตัวของเชื้อราได้

อุณหภูมิแวดล้อมและความชื้นสัมพัทธ์ (ดู "คำวัด ความชื้นสัมพัทธ์", หน้า 63) จะถูกนำมาใช้ในการคำนวณอุณหภูมิของจุดน้ำค้าง (ดู "อุณหภูมิจุดน้ำค้าง", หน้า 63) อุณหภูมิของจุดน้ำค้างจะถูกนำไปเปรียบเทียบกับอุณหภูมิพื้นผิวที่วัดได้และนำไปประเมินถึงความเสี่ยงของการก่อตัวของเชื้อรา

โปรดทราบว่า ผลการวัดจะแสดงให้เห็นภาพตามสภาพแวดล้อมปัจจุบันเท่านั้น ไม่สามารถคาดการณ์สภาพแวดล้อมซึ่งอาจเปลี่ยนแปลงได้ หากผลการวัดถึงค่าวิกฤต คุณควรวัดซ้ำในเวลาและภายใต้เงื่อนไขที่แตกต่างกัน

กดปุ่มสำหรับการวัด (4) เพื่อเริ่มต้นการวัด คำวัดที่แสดงในหน้าจอจะอัปเดตอย่างต่อเนื่อง

หลังจากการวัดเสร็จสิ้น อุณหภูมิพื้นผิวของวัตถุที่วัดล่าสุดจะปรากฏขึ้นบนหน้าจอแสดงผล (n) อุณหภูมิแวดล้อม (h) และค่าวัดความชื้นสัมพัทธ์ในหน้าจอแสดงผล (g) จะปรากฏขึ้นอย่างถาวรบนหน้าจอแสดงผล อุณหภูมิจุดน้ำค้างที่คำนวณได้จะแสดงเป็น (i)

เครื่องมือวัดจะตีความค่าโดยอัตโนมัติเป็นเครื่องหมาย (p) บนสเกลผลลัพธ์ (k):

- เครื่องหมาย (p) ในพื้นที่สีเขียว: ไม่มีความเสี่ยงต่อการเกิดเชื้อราภายใต้สภาวะปัจจุบัน
- เครื่องหมาย (p) ในพื้นที่สีเหลือง: ค่าอยู่ในช่วงจำกัด ให้ตรวจสอบอุณหภูมิห้อง สะพานความร้อน ความชื้น และทำการวัดซ้ำเป็นระยะ หากจำเป็น
- เครื่องหมาย (p) มีความเสี่ยงต่อการเกิดเชื้อราเพิ่มขึ้น เนื่องจากความชื้นสูงเกินไป หรืออุณหภูมิผิวอยู่ใกล้กับช่วงอุณหภูมิจุดน้ำค้าง ค่าที่เห็นได้ชัดเจนจะกะพริบในหน้าจอแสดงผล ค่าแต่ละค่าจะปรากฏขึ้นบนหน้าจอแสดงผล

มีการเตือนให้ทราบถึงความเสี่ยงในการก่อตัวของเชื้อราเมื่อความชื้นพื้นผิว 80% ของอุณหภูมิจุดน้ำค้าง

**หมายเหตุ:** ไม่สามารถตรวจจับสปอร์ของเชื้อราได้ด้วยเครื่องมือวัด จะแสดงเพียงว่า หากเงื่อนไขยังคงเดิม อาจมีการก่อตัวของเชื้อราได้

### โทษอุณหภูมิสัมผัส

การวัดอุณหภูมิแบบสัมผัสส่งผลให้สามารถวัดอุณหภูมิของวัตถุได้โดยตรงโดยใช้เทอร์โมคัปเปิลประเภท K หนึ่งฉนวนป้องกันที่มีจำหน่ายทั่วไป

การวัดอุณหภูมิแบบสัมผัสอาจเป็นประโยชน์โดยใช้ประกอบกับการวัดอุณหภูมิแบบไม่สัมผัส โดยเฉพาะอย่างยิ่ง ในการวัดอินฟราเรดมีข้อเสียโดยธรรมชาติ เช่น สำหรับการวัดอุณหภูมิในอุปกรณ์ ของเหลว การไหลของอากาศ หรือพื้นผิวที่มีค่าสัมประสิทธิ์การแผ่รังสีต่ำ (โลหะเปล่า)

มีหลากหลายแนวทางที่ได้รับการปรับให้เหมาะสมเป็นพิเศษสำหรับการใช้งานต่างๆ สำหรับการวัดในของเหลว การไหลของอากาศ หรือบนพื้นผิว ซึ่งช่วยให้สามารถวัดได้อย่างถูกต้องเมื่อใช้เซ็นเซอร์วัดที่เหมาะสม

อ่านและปฏิบัติตามข้อมูลของผู้ผลิตเทอร์โมคัปเปิล โดยหลักแล้วเทอร์โมคัปเปิลต้องสัมผัสโดยตรงกับวัตถุวัด ค่านี้ถึงอันตรายที่อาจเกิดขึ้นและคำแนะนำด้านความปลอดภัย

ในโหมดนี้ จะทำการวัดเฉพาะอุณหภูมิของเซ็นเซอร์อุณหภูมิเท่านั้น ตัวแปรที่วัดได้อื่น ๆ จะไม่รวมอยู่ในส่วนนี้

**หมายเหตุ:** ให้เฉพาะเทอร์โมคัปเปิลหนึ่งฉนวนป้องกันประเภท K เท่านั้น สำหรับพอร์ตของเทอร์โมคัปเปิลประเภทอื่นอาจส่งผลให้ผลการวัดไม่ถูกต้อง

เปิดฝาครอบ (1) และเชื่อมต่อเทอร์โมคัปเปิลเข้ากับพอร์ต (25)

ทันทีที่เชื่อมต่อเทอร์โมคัปเปิล การแสดงผล (n) จะปรากฏบนหน้าจอแสดงผล คำวัดของการแสดงผลจะอัปเดตอย่างต่อเนื่อง ต้องกดปุ่มวัดสำหรับการวัด (4) ในโหมดนี้และเลเซอร์จะถูกปิดใช้งาน เพื่อให้ได้ผลลัพธ์ที่เชื่อถือได้ ให้อ่อนกว่าค่าวัดไม่เปลี่ยนแปลงต่อไป ขึ้นอยู่กับวิธีดำเนินการเทอร์โมคัปเปิล อาจใช้เวลาหลายนาที

อย่างไรก็ตาม ยังสามารถวัดอุณหภูมิหน้าสัมผัสได้นอกเหนืออุณหภูมิพื้นผิวได้ในแต่ละโหมด จากนั้นคำวัดจะแสดงที่อื่น (s) การระบุสะพานความร้อนและความเสี่ยงของการเกิดเชื้อราจะยึดถือจากอุณหภูมิพื้นผิว (n)

หากถอดเทอร์โมคัปเปิล ไฟแสดงฟังก์ชัน (s) ในหน้าจอแสดงผลจะดับไป หลังจากถอดเทอร์โมคัปเปิล ให้ปิดฝาครอบ (1) เข้า

### โหมดผู้ใช้งาน

ในโหมดผู้ใช้งาน จะมีการวัดอุณหภูมิพื้นผิวและอุณหภูมิแวดล้อม รวมถึงค่าวัดความชื้นสัมพัทธ์ ค่าดังกล่าวจะนำมา

ใช้ในการคำนวณอุณหภูมิจุดน้ำค้างและอุณหภูมิเฉลี่ย (ค่าเฉลี่ยของอุณหภูมิพื้นผิวในระหว่างการวัด)

หากจำเป็นผลสามารถซ่อนค่าต่อไปนี้บนหน้าจอแสดงผล: อุณหภูมิโดยเฉลี่ย ค่าวัดความชื้นสัมพัทธ์ อุณหภูมิแวดล้อม และอุณหภูมิจุดน้ำค้าง

เปิด **<Main Menu>** (เมนูหลัก) เป็น (ดู "ไปที่ **<Main Menu>** (เมนูหลัก)", หน้า 60) เลือกเมนูย่อย **<User Mode>** (โหมดผู้ใช้) คุณสามารถเปิดและปิดหน้าจอแสดงผล **<Average Temp.>** (อุณหภูมิเฉลี่ย), **<Humidity>** (ความชื้น), **<Room Temp.>** (อุณหภูมิห้อง) และ **<Dew Point>** (จุดน้ำค้าง) ได้

สำหรับการวัดอุณหภูมิพื้นผิว คุณสามารถเลือกได้ว่าควรปรับค่าต่ำสุดและสูงสุด (j) ของสเกลผลลัพธ์ (k) โดยอัตโนมัติหรือตั้งค่าด้วยตนเอง ไปยังเมนู **<User Mode>** (โหมดผู้ใช้) ในเมนูย่อย **<Scale Range>** (ช่วงสเกล)

- เลือก **<Auto>** (อัตโนมัติ) ค่า หากต้องการระบุค่า (j) โดยอัตโนมัติตามโหมดอุณหภูมิพื้นผิว ค่าอุณหภูมิต่ำสุดและสูงสุดของกระบวนการวัดจะปรากฏบนหน้าจอแสดงผล (j) ทั้งนี้ที่ความแตกต่างระหว่างค่าวัดมากกว่า 3 °C
- เลือก **<Preset>** (ตั้งล่วงหน้า) เพื่อกำหนดค่าด้วยตนเอง ตั้งค่าที่ต้องการในเมนู **<User Mode>** (โหมดผู้ใช้) ใน **<Scale Lower Limit>** (สเกล ระดับต่ำสุด) และ **<Scale Upper Limit>** (สเกล ระดับสูงสุด) บนหน้าจอแสดงผล (j) จะแสดงค่าต่ำสุดและค่าสูงสุดที่ติดตั้งไว้ด้วยตัวคุณเอง เช่น เพื่อให้สามารถถ่ายภาพหน้าจอของการวัดที่แตกต่างกันได้ด้วยเครื่องหมาย (p)

### สัญญาณเตือนอุณหภูมิพื้นผิว

สามารถใช้ได้สัญญาณเตือนอุณหภูมิพื้นผิวในทุกโหมด ยกเว้นการวัดอุณหภูมิสัมผัส คุณสามารถตั้งอุณหภูมิต่ำสุดและสูงสุดได้

หากต่ำกว่า**อุณหภูมิต่ำสุด** สัญญาณเตือนอุณหภูมิจะกระพริบ (m) สีฟ้าและสัญญาณเตือนจะดังขึ้นหากสัญญาณเสียงเปิดอยู่

หากสูงกว่า**อุณหภูมิสูงสุด** สัญญาณเตือนอุณหภูมิจะกระพริบ (m) สีแดงและสัญญาณเตือนจะดังขึ้นหากสัญญาณเสียงเปิดอยู่

หากต้องการเปิดสัญญาณเตือนอุณหภูมิพื้นผิว ให้ไปยัง **<Main Menu>** (เมนูหลัก) ที่ (ดู "ไปที่ **<Main Menu>** (เมนูหลัก)", หน้า 60).

- เลือกเมนูย่อย **<Alarm>** (สัญญาณเตือน)
- ตั้ง **<Alarm min/max>** (การเตือนภัยต่ำสุด/สูงสุด) เป็น **<On>** (เปิด)
- ปรับอุณหภูมิต่ำสุดที่ **<Alarm min>** (การเตือนภัยต่ำสุด)

- ปรับอุณหภูมิสูงสุดที่ **<Alarm max>** (การเตือนภัยสูงสุด)

อุณหภูมิต่ำสุดและสูงสุดจะถูกบันทึก หากคุณปรับสัญญาณเตือนที่ **<Off>** (ปิด)

### การถ่ายโอนข้อมูล

#### บันทึก/แสดง/ส่งผลการวัด

เมื่อการวัดเสร็จสิ้นสัญลักษณ์จะปรากฏที่หน้าจอแสดงผล ซึ่งแสดงว่าคุณสามารถบันทึกผลการวัดได้ กดปุ่มบันทึก/ปุ่มส่ง (9)

ผลการวัดจะถูกบันทึกเป็นไฟล์ JPG (ภาพหน้าจอของจอแสดงผลผลคงที่)



- สำหรับภาพถ่ายหน้าจอที่บันทึกไว้ใน**หน้าจอแสดงผล** ภาพหน้าจอที่บันทึกไว้กดปุ่มฟังก์ชันด้านซ้าย (17) ได้สัญลักษณ์แกลเลอรี (q) ตอนนี้จะปรากฏภาพที่บันทึกไว้ล่าสุดในจอแสดงผล

- กดปุ่มลูกศรขวา (11) หรือซ้าย (15) เพื่อสลับระหว่างภาพหน้าจอที่บันทึกไว้

- สำหรับการส่งผลการวัดที่แสดงผ่าน Bluetooth® กดปุ่มบันทึก/ส่ง (9) หากยังไม่ได้เปิดการเชื่อมต่อ Bluetooth® (ดู "การถ่ายโอนข้อมูลผ่าน Bluetooth®", หน้า 60) สามารถเปิดใช้งานได้โดยกดปุ่มบันทึก/ส่ง



- หากต้องการลบภาพถ่ายหน้าจอ ให้กดปุ่มฟังก์ชันด้านขวา (10) ได้สัญลักษณ์ถังขยะ



- ในการยืนยันการลบให้กดปุ่มฟังก์ชันด้านซ้าย (17) ได้สัญลักษณ์เครื่องหมายถูก



- หากต้องการยกเลิกกระบวนการลบให้กดปุ่มฟังก์ชันด้านขวา (10) ได้สัญลักษณ์กากบาท



- หากต้องการออกจากมุมมองแกลเลอรีและกลับไปโหมดการวัดให้กดปุ่มฟังก์ชันด้านซ้าย (17) ได้สัญลักษณ์ย้อนกลับ

คุณยังสามารถลบไฟล์ที่บันทึกไว้ทั้งหมดได้ภายในคราวเดียว (ดู "**<Delete All Images>** (ลบรูปภาพทั้งหมด)", หน้า 61)

### ถ่ายโอนข้อมูลผ่านอินเทอร์เน็ต USB

เปิดฝาครอบพอร์ตไมโคร USB (1) เชื่อมต่อพอร์ตไมโคร USB (26) ของเครื่องมือวัดด้วยสายไมโคร USB (8) ที่จัดส่งมาให้เข้ากับคอมพิวเตอร์

เปิดสวิทช์เครื่องมือวัดด้วยปุ่มเปิด-ปิด (12)

เปิดเบราว์เซอร์ไฟล์และเลือกไดรฟ์ **GIS 1000 C** คุณ สามารถคัดลอกไฟล์ต่างๆ ที่บันทึกไว้จากหน่วยความจำ ภายในของเครื่องมือวัด ย้ายไปยังคอมพิวเตอร์ของคุณ หรือ ลบออก

เมื่อสิ้นสุดการดำเนินงานที่ต้องการ ให้ถอดการเชื่อมต่อไดรฟ์ ตามมาตรฐานออกจากคอมพิวเตอร์ และปิดสวิทช์เครื่องมือ วัดด้วยปุ่มเปิด-ปิด (12) อีกครั้ง

**ข้อควรระวัง:** ให้ล็อกเอาท์ไดรฟ์จากระบบปฏิบัติการของคุณ ก่อนทุกครั้ง (eject ไดรฟ์) มิฉะนั้นหน่วยความจำภายในของ เครื่องมือวัดอาจเสียหายได้

ถอดสายเคเบิลไมโคร USB ระหว่างขั้นตอนการวัดและปิด ฝาครอบ (1)

ปิดฝาครอบ USB-อินเทอร์เน็ตเสียบวม ฝุ่นละอองหรือน้ำที่สาด กระเด็นจะไดไม่สามารถถอดเข้าไปในครอบเครื่องได้

**หมายเหตุ:** เชื่อมต่อเครื่องมือวัดผ่าน USB ด้วยคอมพิวเตอร์ เท่านั้น ในขณะที่เชื่อมต่อเข้ากับอุปกรณ์อื่น เครื่องมือวัดอาจ เสียหายได้

#### การถ่ายโอนข้อมูลผ่าน Bluetooth®

เครื่องมือวัดมีโมดูล Bluetooth® ติดตั้งอยู่ ซึ่งช่วยให้ สามารถส่งข้อมูลได้ไร้สายจากเครื่องมือวัดไปยังอุปกรณ์ เคลื่อนที่ปลายทางได้ มีแอปพลิเคชัน Bosch (Apps) พร้อม ให้บริการโดยเฉพาะสำหรับการใช้งาน ท่านสามารถดาวน์โหลด แอปพลิเคชันเหล่านี้ตามประเภทอุปกรณ์ปลายทางได้ จากแหล่งรวมแอปพลิเคชันที่เกี่ยวข้อง



นอกเหนือไปจากการถ่ายทอดข้อมูลของรูปภาพของคุณแบบ ไร้สายแล้ว แอปพลิเคชัน Bosch ช่วยยังช่วยให้คุณสามารถ ขยายขอบเขตการทำงานเพิ่มขึ้น และลดความยุ่งยากของ กระบวนการที่เกิดขึ้นทีหลัง รวมทั้งช่วยส่งต่อข้อมูลที่วัด (เช่น ทางอีเมล) กรุณาค้นหาข้อมูลเกี่ยวกับความต้องการของ ระบบที่จำเป็นสำหรับการเชื่อมต่อ Bluetooth® ได้ที่เว็บไซต์ ของ Bosch

[www.bosch-professional.com/thermal](http://www.bosch-professional.com/thermal)

ในการเปิดการเชื่อมต่อ Bluetooth® ที่เครื่องมือวัด ให้เรียก ใช้ <Main Menu> (เมนูหลัก) ที่ (ดู "ไปที่ <Main Menu> (เมนูหลัก)", หน้า 60) และ ปรับ <Bluetooth> เป็น <On> (เปิด) ในหน้าจอแสดงผล การ

แสดงผล (e) จะปรากฏขึ้น ตรวจสอบให้แน่ใจว่า อินเทอร์เน็ต Bluetooth® เฟสที่อุปกรณ์เคลื่อนที่ปลายทาง ของท่านถูกเรียกใช้งาน

หลังจากเริ่มแอปพลิเคชัน Bosch (เมื่อโมดูล Bluetooth® ทำงานอยู่) การเชื่อมต่อระหว่างอุปกรณ์เคลื่อนที่ปลายทาง และเครื่องมือวัดจะเกิดขึ้น ถ้าพบเครื่องมือวัดที่ทำงานอยู่ หลายเครื่อง ให้เลือกเครื่องมือวัดที่เหมาะสม ถ้าพบเครื่องมือ วัดที่ทำงานอยู่เพียงเครื่องเดียว การเชื่อมต่อจะเกิดขึ้นโดย อัตโนมัติ

**หมายเหตุ:** เมื่อสร้างการเชื่อมต่อ (จับคู่) ระหว่างเครื่องมือ วัดและอุปกรณ์เคลื่อนที่ปลายทาง (เช่น สมาร์ทโฟน แท็บเล็ต) อาจมีการขอรหัส PIN สำหรับเครื่องมือวัด ในกรณีนี้ ให้ป้อน "0000"

เมื่อใช้การถ่ายโอนข้อมูลระยะไกลผ่านทาง Bluetooth® อาจเกิดความล่าช้าทางด้านเวลาระหว่างอุปกรณ์เคลื่อนที่ ปลายทางและเครื่องมือวัดเนื่องจากสภาพการรับสัญญาณไม่ ดี

#### <Main Menu> (เมนูหลัก)

##### ไปที่ <Main Menu> (เมนูหลัก)



- ในการเข้าสู่ <Main Menu> (เมนูหลัก) ในจอแสดงผลหน้าจอตandard ใหม่ มุ่งกั้นด้านขวา (10) ได้สัญลักษณ์เมนู (I)
- ในการเข้าสู่ภายในระดับเมนู ให้กดปุ่มลูกศรชี้ ขึ้น (16) หรือปุ่มลูกศรลงชี้ลง (13) จนกว่า รายการเมนูที่ต้องการจะถูกเน้นด้วยสี



- หากมีเมนูย่อยสำหรับรายการเมนูที่ไฮไลต์จะ แสดงโดยลูกศรชี้ไปทางขวาถัดจาก <Set> (ตั้งค่า) เข้าสู่เมนูย่อยได้โดยกดปุ่มลูกศร ขวา (11)



- หากมีหลายตัวเลือกสำหรับรายการเมนูที่ ไฮไลต์ การตั้งค่าปัจจุบันจะปรากฏขึ้นให้เห็น ระหว่าง 2 ลูกศร หากต้องการเปลี่ยนการตั้ง ค่า ให้กดปุ่มลูกศรซ้าย (15) หรือหรือปุ่มลูก ศรขวา (11) ค่าตัวเลขจะเปลี่ยนเร็วขึ้น หาก คุณกดปุ่มลูกศรดังกล่าวค้างไว้

- ในบางเมนู คุณสามารถเปิดหรือปิดฟังก์ชันได้ หากต้องการปิดใช้งาน ให้กดปุ่มลูกศร ซ้าย (15) เพื่อไฮไลต์ <Off> (ปิด) หาก ต้องการเปิดใช้งาน ให้กดปุ่มลูกศรขวา (11) เพื่อไฮไลต์ <On> (เปิด) คุณสามารถเปิด หรือปิดฟังก์ชันในเมนู ได้โดยกดปุ่มบันทึก/ ส่ง (9)



- เพื่อเปลี่ยนเป็นเมนูต้น ใหกดปุ่มฟังก์ชันด้านซ้าย (17) ได้สัญลักษณ์ย้อนกลับ การตั้งค่าต่างๆ ที่เลือกจะถูกบันทึกไว้



- ในการออกจาก <Main Menu> (เมนูหลัก) และเข้าสู่หน้าจอมาตรฐานโดยตรง ให้ปุ่มฟังก์ชันด้านขวา (10) ได้สัญลักษณ์รูปบ้าน การตั้งค่าต่างๆ ที่เลือกจะถูกบันทึกไว้



- หากต้องการออกจากเมนูใดๆ และกลับสู่หน้าจอการแสดงผลแบบมาตรฐาน คุณยังสามารถกดปุ่มวัด (4) เมื่อกดปุ่มหนึ่งครั้ง การตั้งค่าที่เลือกจะถูกบันทึกไว้ แต่ยังไม่มีการกระตุ้นให้การวัดเริ่มทำงาน

### เมนูย่อยของการวัด

#### <Emissivity value> (ค่าสัมประสิทธิ์การแผ่รังสี) (t)

สำหรับวัสดุที่ซับซ้อนที่สุดบางประเภท เครื่องมีค่าสัมประสิทธิ์การแผ่รังสีที่บันทึกไว้แล้วให้เลือก เพื่อให้การค้นหาลงค่าต่างๆ จะถูกจัดกลุ่มไว้ในแคตตาล็อกแสดงค่าสัมประสิทธิ์การแผ่รังสี เลือกในเมนู <Material> (วัสดุ) ก่อนเลือกหมวดหมู่ที่เหมาะสมและจากนั้นเลือกวัสดุที่เหมาะสม ค่าสัมประสิทธิ์การแผ่รังสีที่สอดคล้องกันจะแสดงในบรรทัดด้านล่าง หากท่านทราบค่าสัมประสิทธิ์การแผ่รังสีที่แน่นอนของวัตถุที่วัด ท่านสามารถปรับตั้งค่านี้เป็นค่าตัวเลขในเมนู

#### <Emissivity value> (ค่าสัมประสิทธิ์การแผ่รังสี)

หากคุณวัดวัสดุชนิดเดียวกันบ่อยครั้ง คุณสามารถบันทึก 5 ค่าสัมประสิทธิ์การแผ่รังสีเป็นรายการโปรดและเรียกใช้อย่างรวดเร็วผ่านแถบด้านบนได้ (เรียงลำดับ 1 ถึง 5)

#### <Reflected Temp.> (อุณหภูมิสะท้อน) (t)

การตั้งค่าพารามิเตอร์เหล่านี้ช่วยปรับปรุงผลการวัดให้ดียิ่งขึ้น โดยเฉพาะอย่างยิ่งสำหรับวัสดุที่มีค่าสัมประสิทธิ์การแผ่รังสี (= การสะท้อนสูง) ในบางสถานการณ์ (โดยเฉพาะภายในอาคาร) อุณหภูมิที่สะท้อนจะสอดคล้องกับอุณหภูมิแวดล้อม หากวัตถุที่มีอุณหภูมิเย็นบนมากอยู่ใกล้กับวัตถุที่สะท้อนแสงมาก และสามารถส่งผลกระทบต่อการวัด ค่านี้ควรถูกปรับเปลี่ยนให้เหมาะสม

### เมนูย่อย <Tool> (เครื่อง)

ไปที่ <Main Menu> (เมนูหลัก) และเลือกเมนูย่อย <Tool> (เครื่อง) ประกอบด้วยรายการเมนูดังต่อไปนี้ <Language> (ภาษา)

ในเมนู <Language> (ภาษา) คุณสามารถเปลี่ยนภาษาหน้าจอแสดงผลทั้งหมดได้

#### <Time & Date> (เวลา & วันที่)

หากต้องการเปลี่ยนวันที่และเวลาบนหน้าจอแสดงผล (a) ให้ไปที่เมนูย่อย <Time & Date> (เวลา & วันที่) ในเมนูย่อยนี้ ท่านสามารถเปลี่ยนรูปแบบของเวลาและวันที่ได้

หากต้องการออกจากเมนูย่อย <Time & Date> (เวลา & วันที่) ให้กดปุ่มฟังก์ชันซ้าย (17) เพื่อบันทึกการตั้งค่า หรือปุ่มฟังก์ชันทางขวา (10) เพื่อยกเลิกการเปลี่ยนแปลง

#### <Unit> (หน่วย)

ในเมนู <Unit> (หน่วย) คุณสามารถเลือกได้ว่าจะแสดงข้อมูลอุณหภูมิเป็น <°C> หรือ <°F>

#### <Laser> (เลเซอร์)

ในเมนู <Laser> (เลเซอร์) คุณสามารถเปิดหรือปิดเลเซอร์ของอุปกรณ์วัดได้ เลเซอร์ใช้เพื่อจำกัดพื้นที่การวัดและดังนั้นจึงควรปิดใช้งานในกรณีพิเศษเท่านั้น

#### <Measuring Frame> (กรอบการวัด)

ในเมนู <Measuring Frame> (กรอบการวัด) คุณสามารถเปิด/ปิด (b) ในหน้าจอแสดงผลได้

#### <Colour Scheme> (ชุดสี)

ในเมนู <Colour Scheme> (ชุดสี) คุณสามารถเลือกได้ว่าค่าอุณหภูมิและการแสดงอื่นๆ ความแสดงให้เห็นเป็นสีใดในหน้าจอแสดงผล การตั้งค่าจะใช้สำหรับภาพถ่ายหน้าจอที่บันทึกไว้ด้วยเช่นกัน

#### <Shutdown Time> (เวลาปิดสวิตช์)

ในเมนู <Shutdown Time> (เวลาปิดสวิตช์) คุณสามารถเลือกช่วงเวลาที่เครื่องมือวัดจะปิดสวิตช์โดยอัตโนมัติเมื่อไม่มีการกดปุ่มใดๆ ท่านสามารถยับยั้งการปิดสวิตช์โดยอัตโนมัติโดยเลือกการตั้งค่า <Never> (ไม่) ไม่ได้ด้วย ยังคงตั้งเวลาปิดเครื่องสั้นลงเพียงใด คุณก็จะประหยัดพลังงานได้มากขึ้นเท่านั้น

#### <Light Duration> (ระยะเวลาส่องสว่าง)

ในเมนู <Light Duration> (ระยะเวลาส่องสว่าง) คุณสามารถเลือกช่วงเวลาหลังจากที่ความสว่างแสงไฟลดลง หากไม่มีการกดปุ่มใดๆ บนเครื่องมือวัด คุณยังสามารถปรับให้จอแสดงผลสว่างขึ้นอย่างถาวรโดยเลือกการตั้งค่า

<Always> (ตลอดเวลา) ยังคงตั้งระยะเวลาการส่องสว่างสั้นลงเพียงใด คุณก็จะประหยัดพลังงานได้มากขึ้นเท่านั้น

#### <Audio Signals> (สัญญาณเสียง)

ในเมนู <Audio Signals> (สัญญาณเสียง) คุณสามารถปิดและเปิดสัญญาณซึ่งเป็นสัญญาณเตือนอุณหภูมิพื้นผิวได้

#### <Delete All Images> (ลบรูปภาพทั้งหมด)

ในเมนู <Delete All Images> (ลบรูปภาพทั้งหมด) คุณสามารถลบแฟ้มทั้งหมดที่เก็บไว้ในหน่วยความจำภายในทั้งหมดได้ภายในคราวเดียว ให้กดปุ่มลูกศรขวา (11) สำหรับ <More> (เพิ่มเติม) เพื่อเข้าสู่เมนูย่อย จากนั้นกดปุ่มฟังก์ชันทางขวา (10) เพื่อลบไฟล์ทั้งหมด หรือปุ่มฟังก์ชันทางซ้าย (17) เพื่อยกเลิกการดำเนินการ

**<Tool Information> (ข้อมูลเครื่อง)**

เข้าสู่เมนูย่อย <Tool Information> (ข้อมูลเครื่อง)

เรียกดูข้อมูลเกี่ยวกับเครื่องมือวัด ตรงนี้ท่านจะพบหมายเลข

เครื่องมือวัดและรุ่นซอฟต์แวร์ที่ติดตั้ง

**<Factory settings> (การตั้งค่าจากโรงงานผลิต)**

ภายใต้รายการเมนูนี้ คุณสามารถรีเซ็ตเครื่องมือวัดกลับคืนสู่

ค่าที่ตั้งจากโรงงานผลิตและลบข้อมูลทั้งหมดอย่างถาวร

กระบวนการนี้อาจใช้เวลาหลายนาที ให้กดปุ่มลูกศร

ขวา (11) สำหรับ <More> (เพิ่มเติม) เพื่อเข้าสู่เมนูย่อย

จากนั้นกดปุ่มฟังก์ชันทางขวา (10) เพื่อลบไฟล์ทั้งหมด หรือ

ปุ่มฟังก์ชันทางซ้าย (17) เพื่อยกเลิกการดำเนินการ

**ข้อผิดพลาด - สาเหตุและมาตรการแก้ไข**

ข้อผิดพลาด	สาเหตุ	มาตรการแก้ไข
ไม่สามารถเปิดใช้งานเครื่องมือวัดได้	แบตเตอรี่แพ็คหรือแบตเตอรี่หมดประจุ	ชาร์จแบตเตอรี่แพ็คหรือเปลี่ยนแบตเตอรี่ใหม่
	แบตเตอรี่แพ็คร้อนหรือเย็นเกินไป	ปล่อยให้แบตเตอรี่เย็นลงหรือเปลี่ยนแบตเตอรี่ใหม่
	หน่วยความจำภาพบกพร่อง	ฟอร์แมตหน่วยความจำภายในโดยลบรูปภาพทั้งหมด (ดู "<Delete All Images> (ลบรูปภาพทั้งหมด)", หน้า 61) หากยังคงเกิดปัญหายังคงให้ส่งเครื่องมือวัดไปยังศูนย์บริการลูกค้า Bosch ที่ผ่านการรับรอง
	หน่วยความจำภาพเต็มแล้ว	หากจำเป็น ให้โอนภาพไปยังสื่อบันทึกข้อมูลอื่น (เช่น คอมพิวเตอร์หรือโน้ตบุ๊ก) จากนั้นให้ลบรูปภาพในหน่วยความจำภายใน
	เครื่องมือวัดชำรุด	ส่งเครื่องมือวัดไปยังศูนย์บริการลูกค้า Bosch ที่ผ่านการรับรอง
ไฟแสดงฟังก์ชัน (s) สำหรับการวัดอุณหภูมิแบบสัมผัสไม่ปรากฏขึ้นหน้าจอแสดงผล	พอร์ต (25) สำหรับเทอร์โมคัปเปิลหรือเทอร์โมคัปเปิลชำรุดเสียหาย	ตรวจสอบการทำงานของเทอร์โมคัปเปิลและส่งเครื่องมือวัดไปยังศูนย์บริการลูกค้า Bosch ที่ผ่านการรับรอง
ไม่สามารถเชื่อมต่อเครื่องมือวัดกับคอมพิวเตอร์ได้	คอมพิวเตอร์ตรวจไม่พบเครื่องมือวัด	ตรวจสอบให้แน่ใจว่าไดรเวอร์ในคอมพิวเตอร์ของคุณเป็นเวอร์ชันล่าสุด อาจต้องใช้ระบบปฏิบัติการเวอร์ชันที่ใหม่กว่าในคอมพิวเตอร์
	พอร์ตไมโคร USB หรือสายไมโคร USB ชำรุดเสียหาย	ตรวจสอบว่าเครื่องมือวัดสามารถเชื่อมต่อกับคอมพิวเตอร์เครื่องอื่นได้หรือไม่ หากไม่เป็นเช่นนั้น ส่งเครื่องมือวัดไปยังศูนย์บริการลูกค้า Bosch ที่ผ่านการรับรอง
	เซ็นเซอร์วัดความชื้นในอากาศและวัดอุณหภูมิแวดล้อม (5) ชำรุดเสียหาย	ยังสามารถใช้งานฟังก์ชันอื่นๆ ของเครื่องมือวัดได้ ส่งเครื่องมือวัดไปยังศูนย์บริการลูกค้า Bosch ที่ผ่านการรับรอง

**คำนิยาม****การแผ่รังสีความร้อนอินฟราเรด**

รังสีความร้อนอินฟราเรดเป็นรังสีแม่เหล็กไฟฟ้าอุณหภูมิ

0 เคลวิน (-273 °C) ที่เปล่งจากทุกส่วนของร่างกาย

ปริมาณรังสีขึ้นอยู่กับอุณหภูมิและการเปล่งรังสีของร่างกาย

**คำสัมประสิทธิภาพแผ่รังสี**

คำสัมประสิทธิภาพแผ่รังสีของวัตถุขึ้นอยู่กับวัสดุและลักษณะ

พื้นผิวของวัสดุ ค่าดังกล่าวบ่งชี้ว่า วัตถุที่ปล่อยออกมา มีรังสี

อินฟราเรดเท่าใดเมื่อเทียบกับการปล่อยรังสีความร้อนที่ต่ำสุด

(ส่วนที่เป็นสีดำ, ค่าสัมประสิทธิ์การแผ่รังสี  $\epsilon = 1$ ) และเป็นค่าระหว่าง 0 และ 1

### อุณหภูมิสะท้อน/การสะท้อนกลับของวัตถุ

อุณหภูมิสะท้อนคือการแผ่รังสีความร้อนที่ไม่ได้ออกมาจากวัตถุเอง รังสีจากสิ่งแวดล้อมจะสะท้อนในวัตถุที่วัตถุนี้ขึ้นอยู่กับโครงสร้างและวัสดุ และดังนั้นจึงบิดเบือนผลอุณหภูมิที่แท้จริง

### สะพานความร้อน

สะพานระบายความร้อนเป็นบริเวณบนผนังด้านนอกของอาคาร บริเวณโครงสร้างที่ส่งผลสูญเสียความร้อนเพิ่มขึ้นในพื้นที่นั้นๆ

เพื่อให้สามารถประเมินสะพานความร้อนได้ สามารถยึดถือข้อกำหนดขั้นต่ำสำหรับฉนวนกันความร้อนตามมาตรฐาน DIN 4108-2

ตามมาตรฐาน DIN 4108-2 ข้อกำหนดขั้นต่ำสำหรับการป้องกันความร้อนจะเป็นไปตามหากปัจจัยอุณหภูมิ  $f_{Rsi}$  สูงกว่า

### 0.7

คำนวณปัจจัยอุณหภูมิ  $f_{Rsi}$  ได้ดังนี้:

$$f_{Rsi} = \frac{T_1 - T_2}{T_3 - T_2}$$

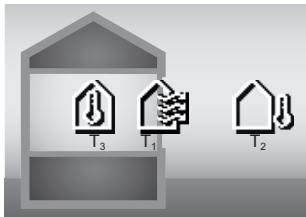

$T_1$ : อุณหภูมิพื้นผิวภายใน

$T_2$ : อุณหภูมิภายนอก

$T_3$ : อุณหภูมิแวดล้อมภายใน

ฉนวนกันความร้อนขั้นต่ำเพื่อหลีกเลี่ยงเชื้อราภายใต้เงื่อนไขขอบเขตมาตรฐาน ซึ่งช่วยหลีกเลี่ยงไม่ให้เป็นอันตรายต่อโครงสร้างอาคาร

ภายใต้สภาวะมาตรฐาน (อุณหภูมิภายนอก  $-5\text{ }^{\circ}\text{C}$ , อุณหภูมิแวดล้อมภายใน  $20\text{ }^{\circ}\text{C}$ ) อุณหภูมิพื้นผิวส่วนบนไม่ควรลดลงต่ำกว่า  $12.6\text{ }^{\circ}\text{C}$  ค่าจำกัด  $f_{Rsi}$  ที่ 0.7 เพื่อให้ได้ผลลัพธ์ที่มีความหมายมากที่สุด (ความไม่แน่นอนเล็กน้อย) อุณหภูมิภายนอกควรต่ำกว่า  $10\text{ }^{\circ}\text{C}$

### ค่าวัดความชื้นสัมพัทธ์

ค่าวัดความชื้นสัมพัทธ์บ่งบอกว่าอากาศอึดด้วยไอน้ำมากเพียงใด ระบุเป็นเปอร์เซ็นต์ของปริมาณไอน้ำสูงสุดที่อากาศสามารถดูดซับได้ ปริมาณไอน้ำสูงสุดขึ้นอยู่กับอุณหภูมิ: ยิ่งอุณหภูมิสูงเท่าไรอากาศก็จะดูดซับไอน้ำได้มากขึ้นเท่านั้น

ความเสี่ยงของการเกิดเชื้อราจะเพิ่มขึ้น หากค่าวัดความชื้นสัมพัทธ์สูงเกินไป ความชื้นที่ต่ำเกินไปอาจทำให้เกิดปัญหาสุขภาพได้

### อุณหภูมิจุดน้ำค้าง

อุณหภูมิจุดน้ำค้างหมายถึงอุณหภูมิที่ไอน้ำที่อยู่ในอากาศเริ่มกลั่นตัวเป็นหยดน้ำ อุณหภูมิจุดน้ำค้างขึ้นอยู่กับความชื้นสัมพัทธ์และอุณหภูมิของอากาศ

หากอุณหภูมิของพื้นผิวต่ำกว่าอุณหภูมิจุดน้ำค้าง น้ำจะเริ่มกลั่นตัวบนพื้นผิวนั้น

การควบแน่นบนพื้นผิวเป็นสาเหตุหลักในการเติบโตของเชื้อรา

## การบำรุงรักษาและการบริการ

### การบำรุงรักษาและการทำความสะอาด

รักษาเครื่องมือวัดให้สะอาดตลอดเวลา เลนส์รับอินฟราเรดที่สกปรก (23) อาจส่งผลกระทบต่อความแม่นยำในการวัด

เช็ดสิ่งสกปรกออกด้วยผ้าที่นุ่มและแห้ง อย่าใช้สารซักฟอกหรือตัวทำละลาย

ขณะทำความสะอาด อย่าให้ช่องเหลวซึมเข้าไปในเครื่องมือวัด

ทำความสะอาดโดยเฉพาะเซ็นเซอร์วัดความชื้นในอากาศและวัดอุณหภูมิแวดล้อม (5), กล้องถ่ายรูป (22), เลนส์รับ (23), ไฟส่องสว่าง (24) และช่องทางออกลำแสงเลเซอร์ (2) ด้วยความระมัดระวังอย่างยิ่ง: ตรวจสอบให้แน่ใจว่า ไม่มีเศษขุยติดบนกล้องถ่ายรูป เลนส์รับ และช่องทางออกลำแสงเลเซอร์ ทำความสะอาดกล้องถ่ายรูป เลนส์รับแสงและทางออกลำแสงเลเซอร์ด้วยสารที่เหมาะสมสำหรับเลนส์กล้องถ่ายรูปเท่านั้น อย่าพยายามใช้วัตถุมีคมเพื่อเช็ดสิ่งสกปรกออกจากเซ็นเซอร์ กล้องถ่ายรูป หรือเลนส์รับ และอย่าเช็ดกล้องถ่ายรูป หรือเลนส์รับ (เสี่ยงต่อการถูกขูดขีด) อย่าเก็บเครื่องมือวัดไว้นอกช่วงความชื้น 30 ถึง 50% ว่าเป็นเวลานาน หากจัดเก็บเครื่องมือวัดความชื้นเกินไป อาจส่งผลให้การวัดไม่ถูกต้องระหว่างการทดสอบ

เนื่องจากตามหลักการแล้ว เซ็นเซอร์ความชื้นในอากาศมีความไวต่อตัวทำละลายเหลวและพลาสติกไซเบอร์ อิทธิพลถาวรของสารดังกล่าวอาจส่งผลกระทบต่อความคลาดเคลื่อนของความชื้นในอากาศที่วัดได้

อย่าเก็บอุปกรณ์ตรวจวัดไว้ในถุงพลาสติก เพราะไอน้ำที่อาจทำให้เซ็นเซอร์วัดความชื้นในอากาศและวัดอุณหภูมิ (5) เสียหายได้ อย่าติดสติ๊กเกอร์ใดๆ กับเซ็นเซอร์บนเครื่องมือวัด

หากคุณต้องการปรับเทียบเครื่องมือวัดของคุณใหม่ โปรดติดต่อศูนย์บริการลูกค้า Bosch ที่ผ่านกรับรอง

เก็บรักษาและขนย้ายเครื่องมือ  
วัดเฉพาะเมื่อบรรจุอยู่ภายในกระเป๋าใส่เครื่องมือวัดที่จัด  
มาให้เท่านั้น

ในกรณีซ่อมแซม ให้ส่งเครื่องมือวัดโดยบรรจุลงในกระเป๋าใส่  
เครื่องมือวัด

### การบริการหลังการขายและการให้คำปรึกษาการ ใช้งาน

ศูนย์บริการหลังการขายของเรายินดีตอบคำถามของ  
ท่านที่เกี่ยวกับการบำรุงรักษาและการซ่อมแซมผลิตภัณฑ์รวม  
ทั้งเรื่องอะไหล่ ภาพเขียนแบบการประกอบและข้อมูลเกี่ยวกับ  
อะไหล่ กรุณาดูใน: [www.bosch-pt.com](http://www.bosch-pt.com)  
ทีมงานที่ปรึกษาของ บ็อสช ยินดีให้ข้อมูลเกี่ยวกับผลิตภัณฑ์  
ของเราและอุปกรณ์ประกอบต่างๆ

เมื่อต้องการสอบถามและสั่งซื้ออะไหล่ กรุณาแจ้งหมายเลข  
สินค้า 10 หลักบนแผ่นป้ายรุ่นของผลิตภัณฑ์ทุกครั้ง

#### ไทย

ไทย บริษัท โรเบิร์ต บ็อสช จำกัด  
เอฟวายไอ เซ็นเตอร์ อาคาร 1 ชั้น 5  
เลขที่ 2525 ถนนพระราม 4  
แขวงคลองเตย เขตคลองเตย กรุงเทพฯ 10110  
โทร: +66 2012 8888  
แฟกซ์: +66 2064 5800  
[www.bosch.co.th](http://www.bosch.co.th)

ศูนย์บริการซ่อมและฝึกอบรม บ็อสช  
อาคาร ลาซาลทาวเวอร์ ชั้น G ห้องเลขที่ 2  
บ้านเลขที่ 10/11 หมู่ 16  
ถนนศรีนครินทร์ ตำบลบางแก้ว อำเภอบางพลี  
จังหวัดสมุทรปราการ 10540  
ประเทศไทย  
โทรศัพท์ 02 7587555  
โทรสาร 02 7587525

สามารถดูที่อยู่ศูนย์บริการอื่นๆ ได้ที่:

[www.bosch-pt.com/serviceaddresses](http://www.bosch-pt.com/serviceaddresses)

#### การขนส่ง

แบตเตอรี่ลิเธียม ไอออน ที่บรรจุอยู่ภายใน  
ได้ข้อกำหนดแห่งกฎหมายสินค้าอันตราย ผู้  
ใช้สามารถขนส่งแบตเตอรี่แพ็คโดย  
ทางถนนโดยไม่มีข้อบังคับอื่นหากขนส่งโดยบุคคลที่สาม  
(เช่น : การขนส่งทางอากาศ หรือตัวแทนขนส่งสินค้า)  
ต้องปฏิบัติตามข้อกำหนดพิเศษเกี่ยวกับการบรรจุ  
ภัณฑ์และการติดฉลาก สำหรับการจัดเตรียมสิ่งของที่จะจัดส่ง  
จำเป็นต้องปรึกษาผู้เชี่ยวชาญด้านวัตถุอันตราย

ส่งแบตเตอรี่แพ็คเมื่อตัวหุ้มไม่ชำรุดเสียหายเท่านั้น ใช้แถบ  
กาวพันปิดหน้าสัมผัสที่เปิดอยู่ และนำแบตเตอรี่แพ็ค  
ใส่กล่องบรรจุโดยไม่ให้เคลื่อนไปมาในกล่องได้ นอกจากนี้  
นี้กรณปฏิบัติตามกฎระเบียบของประเทศซึ่งอาจมีราย  
ละเอียดเพิ่มเติม

#### การกำจัดขยะ



เครื่องมือวัด แบตเตอรี่แพ็ค/แบตเตอรี่ อุปกรณ์  
ประกอบ และที่ห่อ ต้องนำไปแยกประเภทวัสดุ  
เพื่อนำกลับมาใช้ใหม่โดยไม่ทำลายสภาพแวดล้อม



อย่าทิ้งเครื่องมือวัดและแบตเตอรี่แพ็ค/แบตเตอรี่  
ลงในขยะบ้าน!

#### สำหรับประเทศสมาชิกสหภาพยุโรปเท่านั้น:

ตามระเบียบสหภาพยุโรป 2012/19/EU ต้องนำเครื่องมือ  
วัดที่ไม่สามารถใช้งานได้อีกต่อไป และตามระเบียบสหภาพ  
ยุโรป 2006/66/EC ต้องนำแบตเตอรี่แพ็ค/แบตเตอรี่ที่  
ชำรุดหรือใช้แล้วไปเก็บแยกต่างหากและส่งเข้าสู่กระบวนการ  
รีไซเคิลที่เป็นมิตรต่อสิ่งแวดล้อม

#### แบตเตอรี่แพ็ค/แบตเตอรี่:

##### ลิเธียม ไอออน:

กรุณาปฏิบัติตามคำแนะนำในใบถาวรขนส่ง(ดู "การขนส่ง",  
หน้า 64)

## Bahasa Indonesia

### Petunjuk Keselamatan



Petunjuk lengkap ini harus dibaca dan  
diperhatikan agar tidak terjadi bahaya dan  
Anda dapat bekerja dengan aman saat  
menggunakan alat ukur ini. Apabila alat  
ukur tidak digunakan sesuai dengan petunjuk yang  
disertakan, keamanan alat ukur dapat terganggu.  
Janganlah sekali-kali menutupi atau melepas label  
keselamatan kerja yang ada pada alat ukur ini. SIMPAN  
PETUNJUK INI DENGAN BAIK DAN BERIKAN KEPADA  
PEMILIK ALAT UKUR BERIKUTNYA.

- ▶ **Perhatian** - jika perangkat pengoperasian atau  
perangkat pengaturan atau prosedur lain selain yang  
dituliskan di sini digunakan, hal ini dapat  
menyebabkan terjadinya paparan radiasi yang  
berbahaya.
- ▶ **Alat pengukur dikirim dengan tanda peringatan laser**  
(ditandai dengan ilustrasi alat pengukur di halaman  
grafis).



- ▶ **Jika teks pada tanda peringatan laser tidak tertulis dalam bahasa negara Anda, tempelkan label yang tersedia dalam bahasa negara Anda di atas label berbahasa Inggris sebelum Anda menggunakan alat untuk pertama kalinya.**



**Jangan melihat sinar laser ataupun arahnya kepada orang lain atau hewan baik secara langsung maupun dari pantulan.** Sinar laser dapat membakar seseorang, menyebabkan kecelakaan atau merusak mata.

- ▶ **Jika radiasi laser mengenai mata, tutup mata Anda dan segera gerakkan kepala agar tidak terkena sorotan laser.**
- ▶ **Jangan mengubah peralatan laser.**
- ▶ **Jangan gunakan kacamata pelihat laser (aksesori) sebagai kacamata pelindung.** Kacamata pelihat laser digunakan untuk mendeteksi sinar laser dengan lebih baik, namun tidak melindungi dari sinar laser.
- ▶ **Jangan gunakan kacamata pelihat laser (aksesori) sebagai kacamata hitam atau di jalan raya.** Kacamata pelihat laser tidak menawarkan perlindungan penuh terhadap sinar UV dan mengurangi persepsi warna.
- ▶ **Perbaiki alat ukur hanya di teknisi ahli resmi dan gunakan hanya suku cadang asli.** Dengan demikian, keselamatan kerja dengan alat ukur ini selalu terjamin.
- ▶ **Jangan biarkan anak-anak menggunakan alat ukur laser tanpa pengawasan.** Hal ini dapat menyilaukan orang lain atau diri sendiri secara tidak sengaja.
- ▶ **Jangan mengoperasikan alat ukur di area yang berpotensi meledak yang di dalamnya terdapat cairan, gas, atau serbuk yang dapat terbakar.** Di dalam alat pengukur dapat terjadi bunga api, yang lalu menyulut debu atau uap.
- ▶ **Jangan membuka baterai.** Ada bahaya terjadinya korsleting.
- ▶ **Asap dapat keluar apabila terjadi kerusakan atau penggunaan yang tidak tepat pada baterai. Baterai dapat terbakar atau meledak.** Biarkan udara segar mengalir masuk dan kunjungi dokter apabila mengalami gangguan kesehatan. Asap tersebut dapat mengganggu saluran pernafasan.
- ▶ **Penggunaan yang salah pada baterai atau baterai yang rusak dapat menyebabkan keluarnya cairan yang mudah terbakar dari baterai. Hindari terkena cairan ini. Jika tanpa sengaja terkena cairan ini, segera bilas dengan air. Jika cairan tersebut terkena mata, segera hubungi dokter untuk pertolongan lebih lanjut.** Cairan yang keluar dari baterai dapat menyebabkan iritasi pada kulit atau luka bakar.
- ▶ **Baterai dapat rusak akibat benda-benda lancip, seperti jarum, obeng, atau tekanan keras dari luar.** Hal ini dapat menyebabkan terjading hubungan singkat internal dan baterai dapat terbakar, berasap, meledak, atau mengalami panas berlebih.

- ▶ **Jika baterai tidak digunakan, jauhkan baterai dari klip kertas, uang logam, kunci, paku, sekrup, atau benda-benda kecil dari logam lainnya, yang dapat menjembatani kontak-kontak.** Korsleting antara kontak-kontak baterai dapat mengakibatkan kebakaran atau api.
- ▶ **Hanya gunakan baterai pada produk yang dibuat oleh produsen.** Hanya dengan cara ini, baterai dapat terlindungi dari kelebihan muatan.
- ▶ **Hanya isi ulang daya baterai menggunakan alat pengisi daya yang dianjurkan oleh produsen.** Alat pengisi daya baterai yang khusus untuk mengisi daya baterai tertentu dapat mengakibatkan kebakaran jika digunakan untuk mengisi daya baterai yang tidak cocok.



**Lindungi baterai dari panas, misalnya juga dari paparan sinar matahari dalam waktu yang lama, api, kotoran, air dan kelembapan.** Terdapat risiko ledakan dan korsleting.



- ▶ **Lepaskan baterai sebelum bekerja menggunakan alat ukur (misalnya pemasangan, perawatan, dll) serta saat pengangkutan dan penyimpanan.** Terdapat risiko cedera apabila tombol on/off dioperasikan tanpa sengaja.
- ▶ **Waspada! Ketika menggunakan alat ukur dengan Bluetooth® dapat terjadi gangguan pada perangkat dan instalasi lain, pesawat terbang, dan perangkat medis (misalnya alat pacu jantung, alat bantu dengar).** Selain itu, cedera pada manusia dan binatang di area sekitar tidak dapat sepenuhnya dihindari. **Jangan menggunakan alat ukur dengan Bluetooth® di dekat perangkat medis, pusat pengisian bahan bakar, instalasi kimia, area dengan bahaya ledakan. Jangan menggunakan alat ukur dengan Bluetooth® dalam pesawat terbang. Hindari pengoperasian di dekat tubuh secara langsung dalam waktu yang lama.**

Istilah merek *Bluetooth®* serta gambar simbol (logo) merupakan merek dagang terdaftar dan kepemilikan dari Bluetooth SIG, Inc. Setiap penggunaan istilah merek/gambar simbol ini berada di bawah lisensi Robert Bosch Power Tools GmbH.

- ▶ **Lindungi alat ukur, terutama area sensor kelembapan udara, sensor suhu sekitar, dan sensor inframerah dari kelembapan, salju, debu, dan kotoran. Lensa penerima dapat berembun atau terkontaminasi dan mendistorsi hasil pengukuran.** Pengaturan perangkat yang tidak tepat dan faktor-faktor atmosfer lainnya dapat menyebabkan kesalahan pengukuran. Objek dapat ditampilkan dengan suhu lebih tinggi atau lebih rendah yang dapat menimbulkan bahaya apabila disentuh.
- ▶ **Pengukuran suhu yang tepat hanya dapat dilakukan apabila emisivitas yang diatur dan emisivitas objek telah sesuai, serta suhu yang terpantul dan yang benar telah diatur.** Objek dapat ditampilkan dengan suhu lebih tinggi atau lebih rendah yang dapat menimbulkan bahaya apabila disentuh.

## Petunjuk keselamatan saat menggunakan termokopel

- **Termokopel tidak boleh digunakan pada sistem kelistrikan yang dialiri listrik. Terdapat risiko kematian!**
- **Terdapat kontak dengan objek pengukuran akibat penggunaan termokopel.** Oleh karena itu, perhatikan potensi bahaya yang diakibatkan oleh suhu, tegangan, atau reaksi kimia.

## Spesifikasi produk dan performa

Perhatikan ilustrasi yang terdapat pada bagian depan panduan pengoperasian.

### Tujuan penggunaan

Alat ukur ini dirancang untuk mengukur suhu permukaan, suhu sekitar, dan kelembapan relatif tanpa adanya kontak. Alat ukur ini menghitung suhu titik embun dan menunjukkan adanya jembatan termal dan risiko jamur. Spora jamur tidak dapat dideteksi dengan alat ukur. Namun alat ukur dapat membantu mendeteksi lebih awal kondisi yang dapat mendorong terbentuknya jamur.

Alat ukur ini tidak boleh digunakan untuk mengukur suhu manusia dan binatang atau tujuan medis lainnya.

Alat ukur ini tidak sesuai untuk mengukur suhu permukaan gas.

Pengukuran suhu pada cairan hanya dapat dilakukan dengan menggunakan termokopel standar (tipe sambungan K) yang dapat disambungkan ke alat pengukur melalui antarmuka **(25)** yang disediakan.

Dengan termokopel, pengukuran suhu permukaan juga dapat dilakukan dengan menyentuh suatu permukaan.

Lampu dari alat ukur ini dirancang untuk menerangi area kerja alat ukur untuk mengambil gambar.

Titik laser tidak boleh digunakan sebagai penunjuk laser. Titik laser hanya digunakan untuk memberi tanda pada permukaan pengukuran.

Alat ukur ditujukan untuk digunakan di dalam maupun di luar ruangan.





### Ilustrasi komponen

Nomor-nomor pada ilustrasi komponen sesuai dengan gambar alat pengukur pada halaman gambar.

- (1)** Penutup soket Micro-USB/sambungan termokopel (tipe K)
- (2)** Outlet sinar laser
- (3)** Tombol pelepas baterai/adaptor baterai/tutup kompartemen baterai
- (4)** Tombol ukur/tombol on
- (5)** Sensor kelembapan udara dan sensor suhu sekitar
- (6)** Nomor seri
- (7)** Label peringatan laser
- (8)** Kabel Micro-USB

- (9)** Tombol simpan/kirim (*Bluetooth*<sup>®</sup>)
  - (10)** Tombol fungsi sisi kanan
  - (11)** Tombol panah ke kanan
  - (12)** Tombol on/off
  - (13)** Tombol panah ke bawah/mengurangi level pembesaran
  - (14)** Tombol lampu on/off
  - (15)** Tombol panah ke kiri
  - (16)** Tombol panah ke atas/meningkatkan level pembesaran
  - (17)** Tombol fungsi sisi kiri
  - (18)** Display
  - (19)** Tutup pelindung untuk sensor kelembapan udara dan sensor suhu sekitar
  - (20)** Penahan untuk strap
  - (21)** Tutup pelindung untuk lensa penerima inframerah
  - (22)** Kamera
  - (23)** Lensa penerima radiasi inframerah
  - (24)** Lampu
  - (25)** Sambungan tipe K untuk termokopel
  - (26)** Soket Micro-USB
  - (27)** Wadah adaptor baterai<sup>a)</sup>
  - (28)** Tutup pengunci adaptor baterai<sup>a)</sup>
  - (29)** Kompartemen baterai
  - (30)** Baterai<sup>a)</sup>
  - (31)** Tutup kompartemen baterai<sup>a)</sup>
- a) **Aksesori yang ada pada gambar atau yang dijelaskan tidak termasuk dalam lingkup pengiriman standar. Semua aksesori yang ada dapat Anda lihat dalam program aksesori kami.**

### Elemen indikator (lihat gambar A)

- (a)** Tanggal/waktu (lihat „<Waktu & tanggal>“, Halaman 74)
- (b)** Bingkai pengukuran (lihat „Permukaan pengukuran pada pengukuran suhu permukaan“, Halaman 70)
- (c)** Indikator status:
  -  Alat ukur siap untuk melakukan pengukuran, tekan tombol ukur **(4)**.
  -  Pengukuran (kontinu) sedang berlangsung, laser diaktifkan.
  -  Pengukuran berakhir, laser dinonaktifkan, hasil pengukuran telah ditentukan.
  -  Mode suhu kontak, laser telah dinonaktifkan, pengukuran hanya berlangsung melalui termokopel.
- (d)** Indikator level pembesaran (lihat „Mengatur level pembesaran“, Halaman 70)
- (e)** Indikator *Bluetooth*<sup>®</sup> diaktifkan (lihat „Pengiriman data melalui *Bluetooth*<sup>®</sup>“, Halaman 73)

- (f) Indikator level baterai
- (g) Indikator fungsi/nilai ukur untuk kelembapan udara relatif
- (h) Indikator fungsi/nilai ukur untuk suhu sekitar
- (i) Indikator fungsi/hasil suhu titik embun
- (j) Nilai ukur minimal/maksimal untuk suhu permukaan selama proses pengukuran
- (k) Skala hasil
- (l) Simbol menu
- (m) Indikator alarm suhu permukaan (lihat „Alarm suhu permukaan“, Halaman 72)
- (n) Nilai ukur
- (o) Mode saat ini
- (p) Tanda untuk nilai ukur atau hasil (tergantung mode yang dipilih)
- (q) Simbol galeri
- (r) Indikator fungsi/nilai ukur untuk suhu rata-rata
- (s) Indikator fungsi/nilai ukur untuk suhu kontak
- (t) Indikator emisivitas/suhu yang dipantulkan
- (u) Suhu luar yang diatur (mode jembatan termal)
- (v) Indikator nilai  $f_{Rs}$  dengan toleransi (mode jembatan termal)

### Data teknis

Detektor termal	GIS 1000 C	GIS 1000 C
Nomor seri	<b>3 601 K83 3..</b>	<b>3 601 K83 371</b>
Area kerja	0,1–5 m	0,1–5 m
Area pengukuran		
– Suhu permukaan	–40 ... +1000 °C	–40 ... +1000 °C
– Suhu kontak	–40 ... +1000 °C	–40 ... +1000 °C
– Suhu sekitar	–10 ... +50 °C	–10 ... +50 °C
– Kelembapan udara relatif	0 ... 100%	0 ... 100%
<b>Ketepatan pengukuran<sup>A)</sup></b>		
<b>Suhu permukaan<sup>B)</sup></b>		
–40 ... –20,1 °C	±2,5 °C	±2,5 °C
–20 ... –0,1 °C	±1,5 °C	±1,5 °C
<b>0 ... +100 °C</b>	<b>±1 °C</b>	<b>±1 °C</b>
+100 °C ... +400 °C	±1%	±1%
> +400 °C	±2%	±2%
<b>Suhu sekitar</b>	±1 °C	±1 °C
<b>Kelembapan udara relatif<sup>C)</sup></b>		
< 20%	±3%	±3%
<b>20 ... 60%</b>	<b>±2%</b>	<b>±2%</b>
60 ... 90%	±3%	±3%
Optik (rasio jarak pengukuran : titik ukur) <sup>D)E)</sup>	50 : 1	50 : 1
Kelas laser	2	2
Jenis laser	635 nm, < 1 mW	635 nm, < 1 mW
Divergensi (sudut penuh)	< 1,5 mrad	< 1,5 mrad
Tinggi penggunaan maks. di atas tinggi acuan	2000 m	2000 m
Tingkat polusi sesuai dengan IEC 61010-1	2 <sup>F)</sup>	2 <sup>F)</sup>
Kelembapan udara relatif maks.	90%	90%
Baterai (alkali)	4 × 1,5 V LR6 (AA) (dengan adaptor baterai)	4 × 1,5 V LR6 (AA)
Baterai (Li-ion)	10,8 V/12 V	–
Durasi pengoperasian		
– Baterai (alkali)	3 h	3 h

Detektor termal	GIS 1000 C	GIS 1000 C
- Baterai (Li-ion) <sup>G)</sup>	10 h	-
Jumlah gambar dalam memori gambar internal	> 200	> 200
Bluetooth® (Classic and Low Energy)	4.2 <sup>H)</sup>	4.2 <sup>H)</sup>
Rentang frekuensi pengoperasian	2402–2480 MHz	2402–2480 MHz
Daya transmisi maks.	2,5 mW	2,5 mW
Port USB	2.0	2.0
Berat sesuai dengan EPTA-Procedure 01:2014 <sup>G)</sup>	0,56–0,77 kg	0,51 kg
Dimensi (panjang × lebar × tinggi)	136 × 89 × 214 mm	136 × 89 × 214 mm
Kondisi sekitar		
- Suhu sekitar yang direkomendasikan saat pengisian daya	0 °C ... +35 °C	-
- Suhu sekitar yang diizinkan saat pengoperasian	-10 °C ... +50 °C	-10 °C ... +50 °C
- Suhu sekitar yang diizinkan saat penyimpanan tanpa baterai	-20 °C ... +70 °C	-20 °C ... +70 °C
- Suhu sekitar yang diizinkan saat penyimpanan dengan baterai	-20 °C ... +50 °C	-
Baterai yang direkomendasikan	GBA 10,8V... GBA 12V...	-
Perangkat pengisian daya yang direkomendasikan	GAL 12...	-

- A) plus selisih yang bergantung pada penggunaan (misalnya pantulan, jarak, suhu sekitar)  
 B) jika suhu sekitar sebesar +20 °C ... +23 °C, emisivitas > 0,999, jarak ukur sebesar 0,3 m, bukaan sebesar 60 mm  
 C) jika suhu sekitar sebesar +15 °C ... +40 °C  
 D) Data sesuai dengan VDI/VDE 3511 lembar 4.3 (Tanggal publikasi Juli 2005); berlaku untuk 90 % sinyal ukur. Penyimpangan hasil ukur dapat terjadi di semua area di luar ukuran yang ditunjukkan pada data teknis.  
 E) mengacu pada pengukuran inframerah, lihat grafik:

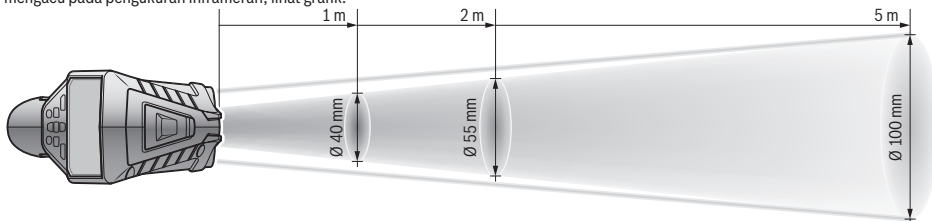

- F) Hanya polusi nonkonduktif yang terjadi, namun terkadang muncul konduktivitas sementara yang disebabkan oleh kondensasi.  
 G) tergantung pada baterai yang digunakan  
 H) Pada perangkat Bluetooth® Low Energy, tidak ada sambungan yang dapat dibuat bergantung model dan sistem pengoperasian. Perangkat Bluetooth® harus mendukung profil SPP.

Alat ukur dapat diidentifikasi dengan jelas menggunakan nomor seri **(6)** pada label tipe.

## Pemasangan

### Suplai daya alat ukur

Alat ukur dapat dioperasikan dengan baterai komersial biasa atau dengan baterai isi ulang li-ion merek Bosch.

Nomor seri **3 601 K83 371**: Alat ukur hanya dapat dioperasikan dengan baterai standar.

### Pengoperasian dengan baterai

**(bukan pada nomor seri 3 601 K83 371) (lihat gambar B)**

Baterai dimasukkan ke dalam adaptor baterai.

### ► Adaptor baterai hanya untuk digunakan pada alat ukur Bosch yang disediakan dan tidak boleh digunakan dengan perkakas listrik.

Untuk **memasang** baterai, dorong wadah **(27)** adaptor baterai ke dalam kompartemen baterai **(29)**. Masukkan baterai ke dalam wadah adaptor baterai sesuai ilustrasi yang terdapat pada tutup pengunci **(28)**. Geser tutup pengunci pada wadah adaptor baterai hingga mengunci rapat.



Untuk **melepas** baterai, tekan tombol pelepas baterai **(3)** pada tutup pengunci **(28)** lalu lepaskan tutup pengunci. Pada saat melepas, pastikan baterai tidak terjatuh. Untuk itu, pegang alat ukur dengan mengarahkan

kompartmenten baterai (29) ke atas. Lepaskan baterai. Untuk melepaskan wadah adaptor baterai yang terpasang di dalam (27) dari kompartemen baterai, pegang wadah adaptor baterai lalu tarik keluar dari alat ukur dengan sedikit ditekan pada sisi samping.

Selalu ganti semua baterai sekaligus. Hanya gunakan baterai dari produsen dan dengan kapasitas yang sama.

- ▶ **Keluarkan baterai dari alat pengukur jika tidak digunakan dalam waktu yang lama.** Jika baterai disimpan di dalam alat pengukur untuk waktu yang lama, baterai dapat berkarat dan dayanya akan habis dengan sendirinya.

#### **Pengoperasian dengan baterai (bukan pada nomor seri 3 601 K83 371) (lihat gambar C)**

- ▶ **Hanya gunakan pengisi daya yang terdaftar dalam data teknis.** Hanya pengisi daya ini yang sesuai pada baterai Li-ion yang dapat digunakan untuk alat Anda.

**Catatan:** Menggunakan baterai yang tidak sesuai untuk alat ukur dapat menyebabkan kegagalan fungsi atau kerusakan pada alat ukur.

**Catatan:** Baterai dikirim dalam keadaan terisi sebagian. Untuk menjamin daya penuh dari baterai, lakukan pengisian baterai hingga penuh sebelum menggunakannya untuk pertama kali.

Daya baterai Li-ion dapat diisi setiap saat tanpa mengurangi masa pakainya. Penghentian proses pengisian daya tidak merusak baterai.

Untuk **memasang** baterai (30) yang telah terisi daya, masukkan baterai ke dalam kompartemen baterai (29) hingga terkunci dan terpasang secara merata pada alat ukur.

Untuk **melepas** baterai (30), tekan tombol pelepas baterai (3) lalu keluarkan baterai dari kompartemen baterai (29). **Jangan melepas baterai dengan paksa.**

#### **Pengoperasian dengan baterai (3 601 K83 371) (lihat gambar D)**

Untuk membuka tutup kompartemen baterai (31), tekan tombol pelepas baterai (3) dan lepaskan tutup kompartemen baterai.

Saat memasang baterai, pastikan baterai terpasang pada posisi kutub yang benar sesuai ilustrasi pada tutup kompartemen baterai.

Pasang kembali tutup kompartemen baterai (31) dan pastikan terkunci dengan benar.

Selalu ganti semua baterai sekaligus. Hanya gunakan baterai dari produsen dan dengan kapasitas yang sama.

- ▶ **Keluarkan baterai dari alat pengukur jika tidak digunakan dalam waktu yang lama.** Jika baterai disimpan di dalam alat pengukur untuk waktu yang lama, baterai dapat berkarat dan dayanya akan habis dengan sendirinya.

## **Pengoperasian**

### **Pengoperasian pertama kali**

- ▶ **Lindungilah alat pengukur dari cairan dan sinar matahari langsung.**
- ▶ **Jauhkan alat pengukur dari suhu atau perubahan suhu yang ekstrem.** Jangan biarkan alat pengukur berada terlalu lama di dalam kendaraan. Biarkan alat pengukur menyesuaikan suhu lingkungan sebelum dioperasikan saat terjadi perubahan suhu yang drastis. Pada suhu yang ekstrem atau terjadi perubahan suhu yang drastis, ketepatan alat pengukur dapat terganggu.
- ▶ **Perhatikan penyesuaian suhu yang tepat pada alat ukur.** Pada perubahan suhu yang ekstrem, waktu aklimatisasi dapat mencapai hingga 60 menit. Hal tersebut dapat terjadi misalnya ketika alat ukur disimpan di dalam mobil yang dingin dan kemudian dilakukan pengukuran di dalam bangunan yang hangat.
- ▶ **Jagalah supaya alat ukur tidak terbentur atau terjatuh.** Sebaiknya lakukan pemeriksaan di pusat layanan resmi **Bosch** setelah alat ukur terkena guncangan atau benturan keras dan saat mengalami kelainan fungsi.

### **Menghidupkan/mematikan**

Lepaskan tutup pelindung (21) dari lensa penerima inframerah (23) dan lepaskan tutup pelindung (19) dari sensor kelembapan udara dan sensor suhu sekitar (5).

**Selama pengerjaan, pastikan kamera (22), lensa penerima (23), dan sensor (5) tidak tertutup atau terhalang karena jika demikian, pengukuran tidak dapat dilakukan dengan tepat.**

Untuk **menghidupkan** alat ukur, tekan tombol on/off (12) atau tombol ukur (4). Rangkaian start akan muncul pada display (18). Setelah muncul rangkaian start, alat ukur akan berada dalam mode pengoperasian yang telah disimpan saat terakhir kali dimatikan. Laser masih belum diaktifkan.

Hanya pada saat alat mulai dioperasikan untuk pertama kalinya, menu **<Perangkat>** juga akan muncul setelah rangkaian start dan pada menu ini, pengaturan alat ukur seperti bahasa untuk semua indikator dapat ditetapkan (lihat „Submenu **<Perangkat>**“, Halaman 74). Konfirmasi pengaturan yang dipilih dengan menekan tombol fungsi sisi kanan (10). Semua pengaturan juga dapat diubah di lain waktu pada submenu **<Perangkat>**.

- ▶ **Jangan biarkan alat ukur yang aktif berada di luar pengawasan dan matikan alat ukur setelah digunakan.** Sinar laser dapat menyilaukan mata orang lain.
- ▶ **Jangan mengarahkan sinar laser pada orang lain atau binatang dan jangan melihat ke sinar laser, juga tidak dari jarak jauh.**

Pada pengaturan pabrik, kecerahan pencahayaan display akan berkurang 30 detik setelah setiap tombol ditekan guna menghemat energi. Ketika tombol mana pun ditekan, pencahayaan display akan kembali dinyalakan dengan kecerahan maksimal. Pada menu **<Waktu lampu>**, waktu pencahayaan tersebut dapat diubah (lihat „**<Waktu lampu>**“, Halaman 74).

Untuk **mematikan** alat ukur, tekan tombol on/off **(12)**. Alat ukur menyimpan mode pengoperasian saat ini beserta pengaturan dan kemudian mati secara otomatis. Pasang kembali tutup pelindung **(21)** pada lensa penerima **(23)** dan tutup pelindung **(19)** pada sensor kelembapan udara dan sensor suhu sekitar **(5)**.

Jangan mematikan alat ukur dengan cara melepas baterai atau adaptor baterai karena dalam keadaan yang tidak menguntungkan hal tersebut dapat merusak memori internal.

Pada menu utama, alat ukur dapat diatur untuk mati secara otomatis begitu pula waktunya (lihat „**<Waktu penonaktifan>**“, Halaman 74) tanpa perlu menekan tombol/melakukan pengukuran. Mode pengoperasian saat ini beserta pengaturan juga akan disimpan saat alat mati secara otomatis.

Jika baterai atau alat ukur tidak berada dalam rentang suhu pengoperasian yang telah ditentukan dalam data teknis, alat ukur akan mati secara otomatis setelah muncul peringatan singkat (lihat „**Gangguan – Penyebab dan Solusi**“, Halaman 75). Biarkan alat ukur menyesuaikan suhu sekitar dan kemudian hidupkan lagi.

## Persiapan mengukur

### Mengatur emisivitas untuk pengukuran suhu permukaan

Untuk menentukan suhu permukaan, radiasi panas inframerah alami akan diukur tanpa adanya kontak yang dipancarkan oleh objek tujuan. Untuk pengukuran yang tepat, emisivitas yang telah diatur pada alat ukur harus diperiksa **setiap sebelum pengukuran dilakukan** dan jika perlu, disesuaikan ke objek pengukuran.

Emisivitas yang telah diatur sebelumnya pada alat ukur menjadi nilai pedoman.

Anda dapat memilih salah satu emisivitas preset atau memasukkan nilai angka yang tepat. Atur emisivitas yang diinginkan melalui menu **<Pengukuran>** → **<Nilai emisivitas>** (lihat „**<Menu utama>**“, Halaman 73).

► **Pengukuran suhu yang tepat hanya dapat dilakukan apabila emisivitas yang diatur dan emisivitas objek telah sesuai, serta suhu yang terpantul dan yang benar telah diatur.** Objek dapat ditampilkan dengan suhu lebih tinggi atau lebih rendah yang dapat menimbulkan bahaya apabila disentuh.

Semakin sedikit emisivitas, maka pengaruh dari suhu yang terpantul pada hasil pengukuran akan semakin besar. Oleh karena itu, selalu sesuaikan suhu yang terpantul jika emisivitas diubah. Atur suhu yang terpantul melalui menu **<Pengukuran>** → **<Suhu dipantulkan>** (lihat „**<Menu utama>**“, Halaman 73).

Jika terdapat beberapa objek pengukuran dengan emisivitas yang berbeda-beda dalam permukaan pengukuran yang telah ditandai oleh laser, pengukuran suhu dapat terdistorsi.

### Permukaan pengukuran pada pengukuran suhu permukaan

Titik laser yang dibuat oleh alat ukur membatasi permukaan pengukuran melingkar di bagian luar. Nilai pengukuran suhu

yang ditampilkan menunjukkan suhu permukaan rata-rata dalam permukaan tersebut.

► **Jangan mengarahkan sinar laser pada orang lain atau binatang dan jangan melihat ke sinar laser, juga tidak dari jarak jauh.**

Jarak titik-titik laser dan dengan demikian ukuran area pengukuran akan bertambah seiring dengan jarak antara alat ukur dengan objek pengukuran.

Jika titik-titik laser sulit terlihat, **<Skala ukur>** **(b)** pada display dapat diaktifkan (lihat „**<Skala ukur>**“, Halaman 74). Bingkai pengukuran dapat digunakan sebagai indikator untuk permukaan pengukuran dan membantu meningkatkan orientasi. Bingkai pengukuran dapat berbeda dari permukaan pengukuran bergantung pada jarak pengukuran. Area yang berada di antara titik laser menentukan pengukuran.

### Petunjuk mengenai kondisi pengukuran

Permukaan yang memantulkan cahaya dengan kuat, mengilat, atau transparan (misalnya ubin yang memantulkan cahaya, bagian depan stainless steel, atau panci memasak) dapat memengaruhi pengukuran suhu permukaan. Bila perlu, pasang permukaan pengukuran dengan lakban hitam sebagai konduktor yang baik. Biarkan lakban menyesuaikan suhu di permukaan secara singkat.

Pengukuran pada material yang transparan pada dasarnya tidak dapat dilakukan.

Jika kondisi pengukuran lebih stabil dan lebih baik, maka hasil pengukuran dapat semakin tepat dan dapat diandalkan. Sensor kelembapan udara dan sensor suhu sekitar **(5)** dapat menjadi rusak akibat polutan kimia seperti misalnya uap pernis atau cat. Pengukuran suhu inframerah dapat terkontaminasi oleh asap, uap atau udara berdebu.

Oleh karena itu, alirkan udara di ruangan sebelum mengukur, terutama bila udara kotor atau lembap. Jangan lakukan pengukuran, misalnya di kamar mandi, setelah kamar mandi baru digunakan.

Biarkan ruangan dialiri udara untuk menyesuaikan suhu hingga ruangan mencapai suhu normal.

Suhu sekitar dan kelembapan udara relatif diukur langsung pada alat ukur pada sensor kelembapan udara dan sensor suhu sekitar **(5)**. Untuk hasil yang signifikan, jangan memegang alat ukur tepat di atas atau di samping sumber gangguan seperti pemanas atau cairan terbuka. Jangan pernah menutupi sensor **(5)**.

Saat menggunakan permukaan yang memantul, perhatikan sudut pengukuran sehingga radiasi panas yang dipantulkan dari objek lainnya tidak mendistorsi hasil. Misalnya, saat melakukan pengukuran vertikal dari depan, pantulan suhu tubuh dapat memengaruhi pengukuran.

### Mengatur level pembesaran

Selama pengukuran berlangsung dan ketika memutar ulang tangkapan layar yang disimpan, gambar pada display dapat ditampilkan dalam 3 level pembesaran yang berbeda: 0,5 m, 2 m dan 5 m.

Level pembesaran telah dioptimalkan pada jarak yang sesuai antara alat ukur dengan objek pengukuran: Pada jarak

pengukuran sebesar 2 m, level pembesaran "**2 m**" akan menampilkan (secara khusus) gambar yang terbaik. Level pembesaran saat ini muncul pada indikator **(d)**. Untuk meningkatkan level pembesaran, tekan tombol panah untuk meningkatkan level pembesaran **(16)** dan untuk mengurangi, tekan tombol panah untuk mengurangi level pembesaran **(13)**.

Akibat adanya paralaks (perubahan posisi sudut), bingkai pengukuran **(b)** hanya menyesuaikan area pengukuran apabila level pembesaran yang dipilih sesuai dengan jarak pengukuran yang sebenarnya.

### Menyinari area pengukuran

Apabila pengukuran dilakukan di area yang gelap, lampu **(24)** dapat dinyalakan untuk membantu meningkatkan tampilan konten gambar. Hal ini dapat membantu memperoleh hasil yang lebih baik saat menyimpan tangkapan layar.

Untuk menyalakan atau mematikan lampu **(24)**, tekan tombol **(14)**.

Ketika kecerahan pencahayaan display berkurang, lampu akan mati secara otomatis untuk menghemat energi. Pada menu **<Waktu lampu>**, waktu pencahayaan tersebut dapat diubah (lihat **„<Waktu lampu>**“, Halaman 74). Saat pencahayaan display menyala kembali, lampu tidak menyala secara otomatis.

Apabila level pengisian daya baterai berada dalam status yang kritis, lampu tidak akan dinyalakan untuk menghemat energi.

### Fungsi pengukuran

#### Beralih di antara mode individual

Pilih mode yang diinginkan menggunakan tombol panah ke kanan **(11)** atau ke kiri **(15)** (mode ditampilkan dengan deskripsi singkat). Untuk menyembunyikan deskripsi lebih awal, tekan tombol simpan **(9)**. Untuk menyembunyikan deskripsi dan segera memulai pengukuran, tekan tombol ukur **(4)**.

#### Mode suhu permukaan

Pada mode suhu permukaan, suhu permukaan dari objek pengukuran akan diukur.

Pada mode tersebut, misalnya radiator dapat diperiksa atau komponen mesin yang panas dapat dicari.

Pengukuran akan dimulai dengan menekan tombol ukur **(4)**. Nilai ukur yang ditampilkan pada display akan diperbarui secara terus-menerus. Begitu tombol ukur **(4)** dilepaskan, pengukuran akan terhenti dan laser akan nonaktif. Hasil pengukuran terakhir pada indikator **(n)** akan disetel pada display. Suhu permukaan yang diukur terakhir kali akan ditampilkan dengan tanda **(p)** pada skala hasil **(k)**.

Nilai suhu minimal dan maksimal dari proses pengukuran muncul pada indikator **(j)** begitu terdapat selisih nilai pengukuran lebih dari 3 °C. Dengan begitu, tinggi nilai pengukuran saat ini terkait suhu yang telah diukur dapat dideteksi.

#### Mode jembatan termal

Alat ukur dapat membantu menemukan jembatan termal (lihat „Jembatan termal“, Halaman 75).

Sebelum pengukuran dapat dimulai, suhu luar harus diatur terlebih dulu. Untuk itu, akses **<Menu utama>** pada (lihat „Mengarahkan dalam **<Menu utama>**“, Halaman 73). Pilih submenu **<Jembatan panas>** lalu atur suhu luar saat ini. Pengukuran akan dimulai dengan menekan tombol ukur **(4)**. Dengan mempertimbangkan suhu sekitar di bagian dalam dan suhu luar, akan ditentukan apakah suhu permukaan sesuai dengan persyaratan minimal untuk insulasi panas. Apabila persyaratan minimal tidak terpenuhi, diduga terdapat kerusakan struktural dan akan muncul peringatan adanya jembatan termal.

Setelah pengukuran selesai dilakukan, akan ditetapkan suhu permukaan dari objek pengukuran yang ditargetkan terakhir kali pada indikator **(n)** dan suhu sekitar pada indikator **(h)**. Nilai  $f_{\text{rsi}}$  yang dihitung (lihat „Jembatan termal“, Halaman 75) beserta estimasi toleransinya akan ditampilkan pada indikator **(v)**.

Alat ukur menampilkan interpretasi nilai dengan tanda **(p)** pada skala hasil **(k)**:

- Tanda **(p)** dalam area berwarna hijau (nilai  $f_{\text{rsi}}$  di atas 0,7, termasuk toleransi): tidak ada jembatan termal
- Tanda **(p)** dalam area berwarna kuning (nilai  $f_{\text{rsi}}$  dalam batas sebesar 0,7): mungkin terdapat jembatan termal dalam area pengukuran. Pada kondisi sekitar yang menguntungkan, pengukuran perlu diulangi (misalnya apabila suhu luar lebih rendah).
- Tanda **(p)** dalam area berwarna merah (nilai  $f_{\text{rsi}}$  di bawah 0,7, termasuk toleransi): mungkin terdapat jembatan termal dalam area pengukuran.

#### Mode titik embun

Alat ukur dapat membantu dalam menemukan posisi yang rawan terkena jamur.

Suhu titik embun (lihat „Suhu titik embun“, Halaman 76) akan dihitung berdasarkan kelembapan udara relatif (lihat „Kelembapan udara relatif“, Halaman 76) dan suhu sekitar yang juga diukur dalam mode ini. Saat menghitung, suhu titik embun akan dibandingkan dengan suhu permukaan yang diukur dan diinterpretasikan terkait dengan risiko pembentukan jamur.

Perhatikan bahwa hasil pengukuran selalu hanya menunjukkan tangkapan layar berdasarkan kondisi sekitar saat ini. Prediksi mengenai kondisi sekitar yang mungkin akan berubah tidak dapat dilakukan. Apabila hasil pengukuran kritis, pengukuran perlu diulangi di waktu dan kondisi yang berbeda.

Pengukuran akan dimulai dengan menekan tombol ukur **(4)**. Nilai ukur yang ditampilkan pada display akan diperbarui secara terus-menerus.

Setelah pengukuran selesai dilakukan, suhu permukaan dari objek pengukuran yang ditargetkan terakhir kali akan ditetapkan pada indikator **(n)**, suhu sekitar pada indikator **(h)**, dan suhu kelembapan relatif pada

indikator **(g)**. Suhu titik embun yang dihitung akan ditampilkan pada **(i)**.

Alat ukur membantu menafsirkan nilai secara otomatis dengan tanda **(p)** pada skala hasil **(k)**:

- Tanda **(p)** dalam area berwarna hijau: Tidak ada risiko jamur dalam kondisi saat ini.
- Tanda **(p)** dalam area berwarna kuning: Nilai berada dalam batas, perhatikan suhu ruangan, jembatan termal, serta kelembapan udara dan ulangi pengukuran dengan interval waktu jika perlu.
- Tanda **(p)** dalam area berwarna merah: Terdapat risiko jamur yang tinggi karena kelembapan udara terlalu tinggi atau suhu permukaan dekat dengan rentang suhu titik embun. Nilai yang terlihat akan berkedip pada indikator.

Peringatan terkait risiko jamur akan muncul apabila suhu permukaan mencapai 80% dari suhu titik embun.

**Catatan:** Spora jamur tidak dapat terdeteksi melalui alat ukur. Alat ukur hanya menunjukkan bahwa jamur dapat terbentuk pada kondisi yang sama.

#### Mode suhu kontak

Pada pengukuran suhu kontak, suhu dari suatu objek dapat diukur secara langsung menggunakan termokopel terlindung standar tipe K.

Pengukuran suhu kontak dapat menjadi tambahan yang berguna untuk pengukuran suhu tanpa kontak. Penggunaan ini sangat berguna terutama dalam situasi yang tidak menguntungkan untuk melakukan pengukuran inframerah, misalnya saat mengukur suhu dalam media, cairan, aliran udara, atau permukaan dengan emisivitas yang rendah (logam mengilat).

Terdapat geometri sensor yang dioptimalkan secara khusus untuk berbagai penggunaan pada cairan, aliran udara, atau pada permukaan yang memungkinkan pengukuran yang tepat ketika menggunakan sensor yang sesuai.

Baca dan perhatikan segala petunjuk dari produsen termokopel.

Penggunaan termokopel memerlukan kontak langsung dengan objek pengukuran. Perhatikan potensi bahaya dan petunjuk keselamatan.

Dalam mode ini, hanya suhu dari sensor suhu yang diukur, nilai ukur lainnya tidak disertakan di sini.

**Catatan:** Hanya gunakan termokopel terlindung tipe K. Dengan menyambungkan termokopel tipe lain, kesalahan hasil pengukuran dapat terjadi.

Buka penutup **(1)** dan sambungkan termokopel ke sambungan **(25)**.

Begitu termokopel telah tersambung, indikator **(n)** akan muncul pada display. Nilai ukur pada indikator akan terus diperbarui. Dalam mode ini, tombol untuk mengukur **(4)** tidak harus ditekan untuk melakukan pengukuran dan laser akan nonaktif. Untuk mendapatkan hasil yang reliabel, tunggu hingga nilai ukur tidak berubah lagi. Hal tersebut dapat berlangsung beberapa menit bergantung pada model termokopel.

Selain suhu permukaan, suhu kontak juga dapat diukur dalam setiap mode. Kemudian, nilai ukur akan ditampilkan

ke posisi lainnya **(s)**. Meskipun demikian, suhu permukaan **(n)** selalu digunakan untuk menentukan jembatan termal dan risiko jamur.

Jika termokopel dilepas, indikator fungsi **(s)** akan menghilang dari display. Setelah termokopel dilepas, tutup kembali penutup **(1)**.

#### Mode pengguna

Dalam mode pengguna, suhu permukaan dan suhu sekitar serta kelembapan udara relatif akan diukur. Suhu titik embun serta suhu rata-rata (nilai rata-rata dari suhu permukaan selama pengukuran berlangsung) akan dihitung berdasarkan hal tersebut.

Jika perlu, nilai pada indikator berikut dapat disembunyikan: suhu rata-rata, kelembapan udara relatif, suhu sekitar, dan suhu titik embun.

Untuk itu, akses **<Menu utama>** pada (lihat „Mengarahkan dalam **<Menu utama>**“, Halaman 73). Pilih submenu **<Mode pengguna>**. Indikator **<Suhu rata-rata>**, **<Kelembaban udara>**, **<Suhu ruangan>**, dan **<Titik embun>** dapat diaktifkan dan dinonaktifkan di sini.

Untuk pengukuran suhu permukaan, Anda dapat memilih apakah nilai minimal dan nilai maksimal **(j)** dari skala hasil **(k)** perlu disesuaikan secara otomatis atau ditetapkan secara manual. Untuk itu, masuk ke submenu **<Rentang skala>** dalam menu **<Mode pengguna>**.

- Pilih **<otomatis>** jika nilai **(j)** seperti dalam mode suhu permukaan perlu ditentukan secara otomatis. Nilai suhu minimal dan maksimal dari proses pengukuran muncul pada indikator **(j)** begitu terdapat selisih nilai pengukuran lebih dari 3 °C.
- Pilih **<set awal>** untuk menentukan nilai secara manual. Atur nilai yang diinginkan dalam menu **<Mode pengguna>** melalui **<Skala batas bawah>** dan **<Skala batas atas>**. Pada indikator **(j)**, nilai minimal dan nilai maksimal yang ditetapkan secara manual akan muncul. Dengan begitu, misalnya tangkapan layar dari pengukuran yang berbeda dapat dibuat serupa menggunakan tanda **(p)**.

#### Alarm suhu permukaan

Alarm suhu permukaan dapat digunakan pada semua mode kecuali pengukuran suhu kontak. Anda dapat menentukan suhu minimal dan suhu maksimal.

Jika **suhu minimal** di bawah batas minimal, indikator alarm suhu **(m)** akan berkedip biru dan sinyal peringatan akan berbunyi apabila sinyal akustik diaktifkan.

Jika **suhu maksimal** terlampaui, indikator alarm suhu **(m)** akan berkedip merah dan sinyal peringatan akan berbunyi apabila sinyal akustik diaktifkan.

Untuk menggunakan alarm suhu permukaan, akses **<Menu utama>** pada (lihat „Mengarahkan dalam **<Menu utama>**“, Halaman 73).

- Pilih submenu **<Alarm>**.
- Atur **<Alarm maks/min>** ke posisi **<hidup>**.
- Pada **<Alarm min>**, atur suhu minimal.
- Pada **<Alarm maks>**, atur suhu maksimal.



Suhu minimal dan maksimal juga akan disimpan ketika alarm diatur ke posisi **<mati>**.

## Pengiriman data

### Menyimpan/menampilkan/mengirim hasil pengukuran

Setelah pengukuran selesai dilakukan, simbol simpan akan muncul pada display sebagai indikator bahwa hasil pengukuran dapat disimpan. Tekan tombol simpan/kirim **(9)**.

Hasil pengukuran akan disimpan sebagai file JPG (tangkapan layar dari display yang ditetapkan).



- Untuk **menampilkan** tangkapan layar yang telah disimpan, tekan tombol fungsi sisi kiri **(17)** di bawah simbol galeri **(q)**. Pada display akan muncul gambar yang telah disimpan terakhir kali.
- Tekan tombol panah ke kanan **(11)** atau ke kiri **(15)** untuk beralih maju dan mundur di antara tangkapan layar yang tersimpan.
- Untuk mengirim hasil pengukuran yang ditampilkan melalui *Bluetooth*<sup>®</sup>, tekan tombol simpan/kirim **(9)**. Apabila koneksi *Bluetooth*<sup>®</sup> masih belum diaktifkan (lihat „Pengiriman data melalui *Bluetooth*<sup>®</sup>“, Halaman 73), aktifkan dengan menekan tombol simpan/kirim.



- Untuk **menghapus** tangkapan layar yang ditampilkan, tekan tombol fungsi sisi kanan **(10)** di bawah simbol tempat sampah.



- Untuk mengonfirmasi proses penghapusan, tekan tombol fungsi sisi kiri **(17)** di bawah simbol tanda centang.



- Untuk membatalkan proses penghapusan, tekan tombol fungsi sisi kanan **(10)** di bawah simbol tanda silang.



- Untuk keluar dari display galeri dan kembali ke mode pengukuran, tekan tombol fungsi sisi kiri **(17)** di bawah simbol kembali.

Semua file yang telah disimpan juga dapat dihapus sekaligus (lihat „**<Hapus semua gambar>**“, Halaman 75).

### Pengiriman data melalui antarmuka USB

Buka penutup soket Micro-USB **(1)**. Sambungkan soket Micro-USB **(26)** alat ukur ke komputer melalui kabel Micro-USB **(8)** yang disediakan.

Kemudian, hidupkan alat ukur dengan tombol on/off **(12)**.

Buka browser file pada komputer dan pilih hard drive **GIS 1000 C**. File yang disimpan dapat disalin dari memori internal alat ukur, dihapus atau dipindahkan ke komputer.

Begitu proses yang diinginkan telah berakhir, putus sambungan hard drive dari komputer, kemudian matikan lagi alat ukur dengan tombol on/off **(12)**.

**Perhatian:** Selalu lakukan log out pada hard drive dari sistem pengoperasian terlebih dulu (keluarkan hard drive)

agar terhindar dari kerusakan pada memori internal alat ukur.

Keluarkan kabel micro USB **selama** mengukur dan tutup penutup **(1)**.

Selalu tutup antarmuka USB sehingga tidak ada debu atau percikan air yang bisa masuk ke dalam housing.

**Catatan:** Hanya sambungkan alat ukur ke komputer melalui USB. Jika disambungkan pada perangkat lain, alat ukur dapat menjadi rusak.

### Pengiriman data melalui *Bluetooth*<sup>®</sup>

Alat ukur dilengkapi dengan modul *Bluetooth*<sup>®</sup> yang memungkinkan pengiriman data nirkabel dari alat ukur ke perangkat seluler. Aplikasi Bosch khusus (app) tersedia untuk penggunaan tersebut. Aplikasi tersebut dapat diunduh di store terkait bergantung pada perangkat.



Selain mengirimkan data secara nirkabel, aplikasi Bosch memungkinkan pengguna untuk meningkatkan fungsi dan menyederhanakan pemrosesan akhir serta mengirimkan data pengukuran (misalnya melalui e-mail). Informasi mengenai persyaratan sistem yang diperlukan untuk koneksi *Bluetooth*<sup>®</sup> dapat ditemukan pada situs internet Bosch di [www.bosch-professional.com/thermal](http://www.bosch-professional.com/thermal).

Untuk mengaktifkan koneksi *Bluetooth*<sup>®</sup> pada alat ukur, akses **<Menu utama>** pada (lihat „Mengarahkan dalam **<Menu utama>**“, Halaman 73) dan atur **<Bluetooth>** ke posisi **<hidup>**. Pada display akan muncul indikator **(e)**. Pastikan antarmuka *Bluetooth*<sup>®</sup> telah diaktifkan pada perangkat seluler.

Setelah aplikasi Bosch dimulai, (dengan modul *Bluetooth*<sup>®</sup> diaktifkan), koneksi antara perangkat seluler dengan alat ukur akan dibuat. Jika ada beberapa alat ukur yang aktif, pilih alat ukur yang sesuai. Jika hanya ada satu alat ukur yang aktif, koneksi akan dibuat secara otomatis.

**Catatan:** Ketika koneksi antara alat ukur dan perangkat seluler (misalnya, smartphone, tablet) dibuat untuk pertama kali (pairing), permintaan kode PIN untuk alat ukur mungkin dapat muncul. Pada situasi tersebut, masukkan "0000".

Saat mengirimkan data melalui *Bluetooth*<sup>®</sup>, sambungan antara perangkat seluler dengan alat ukur dapat berjalan lambat akibat kondisi penerimaan yang buruk.

### **<Menu utama>**

#### Mengarahkan dalam **<Menu utama>**



- Untuk mengakses **<Menu utama>**, tekan tombol fungsi sisi kanan **(10)** di bawah

simbol menu **(I)** pada layar indikator standar.

- Untuk mengarahkan di dalam level menu, tekan tombol panah ke atas **(16)** atau tombol panah ke bawah **(13)** beberapa kali hingga item menu yang diinginkan disorot dengan warna.



- Jika terdapat submenu pada item menu yang disorot, hal tersebut ditandai dengan tanda panah yang menunjuk ke kanan di samping **<setel>**. Untuk mengakses submenu, tekan tombol panah ke kanan **(11)**.



- Jika terdapat beberapa opsi pilihan pada item menu yang disorot, pengaturan saat ini akan ditampilkan di antara 2 tanda panah. Untuk mengubah pengaturan, tekan tombol panah ke kiri **(15)** atau tombol panah ke kanan **(11)**. Nilai angka akan berubah dengan lebih cepat jika tombol panah yang sesuai ditekan lama.

- Fungsi dapat diaktifkan atau dinonaktifkan pada beberapa item menu. Untuk menonaktifkan, tekan tombol panah ke kiri **(15)** hingga **<mati>** disorot. Untuk mengaktifkan, tekan tombol panah ke kanan **(11)** hingga **<hidup>** disorot. Fungsi dalam menu juga dapat diaktifkan dan dinonaktifkan dengan menekan tombol simpan/kirim **(9)**.



- Untuk beralih ke menu atas, tekan tombol fungsi sisi kiri **(17)** di bawah simbol kembali. Pengaturan yang dipilih akan disimpan.



- Untuk keluar dari **<Menu utama>** dan langsung kembali ke layar indikator standar, tekan tombol fungsi sisi kanan **(10)** di bawah simbol rumah. Pengaturan yang dipilih akan disimpan.



- Tombol ukur **(4)** juga dapat ditekan untuk keluar dari menu apa pun dan kembali ke layar indikator standar. Ketika tombol ukur ditekan satu kali, pengaturan yang dipilih akan tersimpan namun tidak ada pengukuran yang dilakukan.

### Submenu pengukuran

#### **<Nilai emisitas> (t)**

Emisitas yang tersimpan akan tersedia sebagai pilihan untuk beberapa material yang sering muncul. Untuk mempermudah pencarian, nilai telah dikelompokkan dalam katalog emisitas. Pertama-tama, pilih kategori yang sesuai pada item menu **<Material>** dan kemudian material yang sesuai. Emisitas terkait akan ditunjukkan pada baris di bawahnya. Apabila emisitas objek pengukuran diketahui secara pasti, emisitas tersebut juga dapat diatur sebagai nilai pada item menu **<Nilai emisitas>**.

Jika material yang sama diukur berulang kali, 5 emisitas

dapat disimpan sebagai favorit dan dapat diakses dengan cepat melalui bar teratas (dinomori mulai 1 hingga 5).

#### **<Suhu dipantulkan> (t)**

Pengaturan parameter ini dapat meningkatkan hasil pengukuran terutama pada material dengan emisitas yang rendah (= pantulan tinggi). Dalam beberapa situasi (terutama di dalam ruangan), suhu yang dipantulkan sesuai dengan suhu sekitar. Jika benda dengan suhu yang sangat berbeda di dekat benda yang memantul kuat dapat memengaruhi pengukuran, nilai tersebut perlu disesuaikan.

#### **Submenu <Perangkat>**

Akses **<Menu utama>** dan pilih submenu **<Perangkat>**. Submenu ini terdiri dari item menu berikut.

##### **<Bahasa>**

Dalam menu **<Bahasa>**, bahasa untuk semua indikator dapat diubah.

##### **<Waktu & tanggal>**

Untuk mengubah tanggal dan waktu pada indikator **(a)**, akses submenu **<Waktu & tanggal>**. Pada submenu ini, format waktu dan tanggal juga dapat diubah.

Untuk keluar dari submenu **<Waktu & tanggal>**, tekan tombol fungsi sisi kiri **(17)** untuk menyimpan pengaturan atau tombol fungsi sisi kanan **(10)** untuk membuang perubahan.

##### **<Unit>**

Pada menu **<Unit>** terdapat opsi apakah satuan suhu ditampilkan dalam **<°C>** atau **<°F>**.

##### **<Laser>**

Pada menu **<Laser>**, laser pada alat ukur dapat diaktifkan atau dinonaktifkan. Laser digunakan untuk membatasi area pengukuran sehingga sebaiknya hanya dinonaktifkan dalam situasi tertentu.

##### **<Skala ukur>**

Pada menu **<Skala ukur>**, bingkai pengukuran **(b)** pada display dapat diaktifkan atau dinonaktifkan.

##### **<Skema warna>**

Pada menu **<Skema warna>**, warna nilai suhu dan tampilan lainnya pada display yang ingin dimunculkan dapat dipilih. Pengaturan juga diterapkan untuk tangkapan layar yang disimpan.

##### **<Waktu penonaktifan>**

Pada menu **<Waktu penonaktifan>**, interval waktu dapat dipilih, setelah itu alat ukur mati secara otomatis saat tidak ada tombol yang ditekan. Penonaktifan otomatis juga dapat dinonaktifkan dengan memilih pengaturan **<Tidak pernah>**. Semakin singkat waktu penonaktifan yang diatur, semakin banyak energi yang dapat dihemat.

##### **<Waktu lampu>**

Pada menu **<Waktu lampu>**, interval waktu dapat dipilih, setelah itu kecerahan pencahayaan display berkurang saat tidak ada tombol pada alat ukur yang ditekan. Display juga dapat dinyalakan terus-menerus dengan memilih pengaturan **<Selalu>**. Semakin singkat durasi cahaya yang diatur, semakin banyak energi yang dapat dihemat.

**<Bunyi sinyal>**

Pada menu **<Bunyi sinyal>**, sinyal akustik yang berbunyi ketika alarm suhu permukaan terpicu dapat diaktifkan atau dinonaktifkan.

**<Hapus semua gambar>**

Pada menu **<Hapus semua gambar>**, semua file yang terdapat di memori internal dapat dihapus sekaligus. Tekan tombol panah ke kanan **(11)** pada **<lebih>** untuk mengakses submenu. Kemudian tekan tombol fungsi sisi kanan **(10)** untuk menghapus semua file atau tekan tombol fungsi sisi kiri **(17)** untuk membatalkan proses.

**<Informasi perangkat>**





Untuk informasi mengenai alat ukur, akses submenu

**<Informasi perangkat>**. Di sana terdapat nomor seri alat ukur dan versi perangkat lunak yang diinstal.

**<Pengaturan pabrik>**

Pada item menu ini, alat ukur dapat diatur ulang ke pengaturan pabrik dan semua data dapat dihapus secara permanen. Hal tersebut dapat berlangsung selama beberapa menit. Tekan tombol panah ke kanan **(11)** pada **<lebih>** untuk mengakses submenu. Kemudian tekan tombol fungsi sisi kanan **(10)** untuk menghapus semua file atau tekan tombol fungsi sisi kiri **(17)** untuk membatalkan proses.

**Gangguan – Penyebab dan Solusi**

Gangguan	Penyebab	Solusi
Alat ukur tidak dapat dihidupkan. 	Daya baterai habis	Isi daya baterai atau ganti baterai.
	Baterai terlalu panas atau terlalu dingin	Biarkan baterai menyesuaikan suhunya atau ganti baterai.
	Memori gambar rusak	Lakukan format memori internal dengan menghapus semua gambar (lihat „ <b>&lt;Hapus semua gambar&gt;</b> “, Halaman 75). Jika masalah tetap muncul, kirimkan alat ukur ke layanan pelanggan resmi Bosch.
	Memori gambar penuh	Jika perlu, pindahkan gambar ke media penyimpanan lainnya (misalnya komputer atau notebook). Kemudian hapus gambar di memori internal.
	Alat ukur rusak	Kirimkan alat ukur ke layanan pelanggan resmi Bosch.
Indikator fungsi <b>(s)</b> untuk pengukuran suhu kontak tidak muncul pada display.	Termokopel atau sambungan <b>(25)</b> untuk termokopel rusak	Periksa fungsi termokopel dan kirimkan alat ukur ke layanan pelanggan resmi Bosch.
Alat ukur tidak dapat tersambung ke komputer.	Alat ukur tidak terdeteksi oleh komputer.	Periksa apakah driver pada komputer telah diperbarui. Versi sistem pengoperasian terbaru pada komputer mungkin diperlukan.
	Port Micro-USB atau kabel Micro-USB rusak	Periksa apakah alat ukur dapat tersambung ke komputer lain. Jika tidak, kirimkan alat ukur ke layanan pelanggan resmi Bosch.
	Sensor kelembapan udara dan sensor suhu sekitar <b>(5)</b> rusak	Fungsi lain dari alat ukur masih dapat digunakan. Kirimkan alat ukur ke layanan pelanggan resmi Bosch.

**Penjelasan istilah****Radiasi panas inframerah**

Radiasi panas inframerah merupakan radiasi elektromagnetik yang dipancarkan oleh setiap benda di atas 0 Kelvin (-273°C). Jumlah radiasi bergantung pada suhu dan emisivitas tubuh.

**Emisivitas**

Emisivitas suatu objek bergantung pada material dan struktur permukaannya. Emisivitas ini menunjukkan kuantitas radiasi panas inframerah yang dipancarkan objek bila dibandingkan dengan pemancar panas ideal (benda hitam, emisivitas  $\epsilon = 1$ ) dan nilainya antara 0 dan 1.

**Suhu yang dipantulkan/pantulan suatu objek**

Suhu yang dipantulkan adalah radiasi panas yang tidak berasal dari benda itu sendiri. Radiasi sekitar akan memantul pada objek yang akan diukur sehingga mendistorsi hasil suhu yang sebenarnya bergantung pada struktur dan material.

**Jembatan termal**

Jembatan termal merupakan posisi pada dinding luar bangunan di mana terjadi hilangnya panas yang meningkat secara lokal akibat konstruksinya.

Agar jembatan termal dapat dievaluasi, persyaratan minimal yang telah dijelaskan sesuai DIN 4108-2 mengenai insulasi panas dapat digunakan.

Berdasarkan DIN 4108-2, persyaratan minimal mengenai insulasi panas terpenuhi apabila faktor suhu  $f_{Rsi}$  lebih besar dari **0,7**.

Faktor suhu  $f_{Rsi}$  menghitung:

$$f_{Rsi} = \frac{T_1 - T_2}{T_3 - T_2}$$

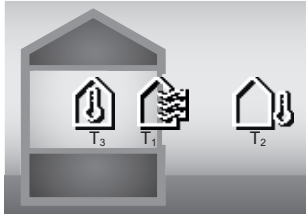

$T_1$ : Suhu permukaan bagian dalam

$T_2$ : Suhu luar

$T_3$ : Suhu sekitar bagian dalam

Insulasi panas minimal digunakan untuk mencegah munculnya jamur dalam kondisi batasan standar. Dengan begitu, risiko bahaya struktur bangunan dapat dihindari.

Dalam kondisi standar (suhu luar sebesar  $-5^\circ\text{C}$ , suhu sekitar bagian dalam  $20^\circ\text{C}$ ), suhu permukaan tidak boleh turun di bawah  $12,6^\circ\text{C}$ . Hal ini sesuai dengan nilai batas  $f_{Rsi}$  sebesar 0,7. Untuk mendapatkan hasil yang paling signifikan (ketidakpastian yang kecil), suhu luar sebaiknya berada di bawah  $10^\circ\text{C}$ .

### Kelembapan udara relatif

Kelembapan udara relatif menentukan seberapa tinggi udara mengandung uap air. Informasi ini diberikan sebagai nilai persentase dari jumlah uap air maksimal yang dapat diserap udara. Jumlah uap air maksimal bergantung pada suhu: semakin tinggi suhu, semakin banyak uap air yang dapat terserap udara.

Jika kelembapan udara relatif terlalu tinggi, risiko jamur akan meningkat. Kelembapan udara yang terlalu rendah dapat mengganggu kesehatan.

### Suhu titik embun

Suhu titik embun menentukan tinggi suhu uap air yang terkandung di udara untuk mulai berkondensasi. Suhu titik embun bergantung pada kelembapan udara relatif dan suhu udara.

Jika suhu pada permukaan lebih rendah dari suhu titik embun, air pada permukaan tersebut akan mulai berkondensasi.

Kondensasi pada permukaan merupakan penyebab utama terbentuknya jamur.

## Perawatan dan servis

### Perawatan dan pembersihan

Jaga kebersihan alat ukur. Lensa penerima inframerah yang kotor **(23)** dapat memengaruhi ketepatan pengukuran.

Jika alat ukur kotor, bersihkan alat dengan lap yang kering dan lembut. Jangan gunakan bahan pembersih atau pelarut. Hati-hati menggunakan caran saat membersihkan alat ukur agar cairan tidak masuk.

Bersihkan sensor kelembapan udara dan sensor suhu **(5)**, kamera **(22)**, lensa penerima **(23)**, lampu **(24)**, dan outlet sinar laser **(2)** dengan sangat hati-hati: Pastikan tidak ada bulu halus pada kamera, lensa penerima atau outlet sinar laser. Hanya bersihkan kamera, lensa penerima, dan outlet sinar laser dengan bahan pembersih yang juga cocok untuk lensa kamera. Jangan coba membersihkan kotoran dari sensor, kamera, atau lensa penerima dengan alat yang tajam, dan jangan mengusap kamera dan lensa penerima (risiko tergores).

Jangan menyimpan alat ukur di luar rentang kelembapan udara dari 30 hingga 50% dalam jangka waktu yang lama. Jika alat ukur disimpan dalam kondisi terlalu lembap atau terlalu kering, hal tersebut dapat menyebabkan terjadinya kesalahan pengukuran ketika alat dioperasikan.

Sensor kelembapan udara pada dasarnya sensitif terhadap cairan pembersih, bahan perekat, serta bahan pelembut. Pengaruh permanen dari bahan-bahan tersebut dapat menyebabkan penyimpangan pada kelembapan udara yang diukur.

Jangan menyimpan alat pengukur di dalam kantong plastik yang penguapannya dapat merusak sensor kelembapan udara dan sensor suhu **(5)**. Jangan memasang stiker di dekat sensor pada alat ukur.

Apabila ingin melakukan kalibrasi ulang pada alat ukur, hubungi layanan pelanggan resmi Bosch.

Simpan dan bawalah alat pengukur hanya di dalam kantong pelindung yang telah disertakan.

Kirimkan alat pengukur untuk diperbaiki dengan menyimpannya di dalam tas pelindung.

### Layanan pelanggan dan konsultasi penggunaan

Layanan pelanggan Bosch menjawab semua pertanyaan Anda tentang reparasi dan perawatan serta tentang suku cadang produk ini. Gambaran teknis (exploded view) dan informasi mengenai suku cadang dapat ditemukan di:

**[www.bosch-pt.com](http://www.bosch-pt.com)**

Tim konsultasi penggunaan Bosch akan membantu Anda menjawab pertanyaan seputar produk kami beserta aksesorinya.

Jika Anda hendak menanyakan sesuatu atau memesan suku cadang, selalu sebutkan nomor model yang terdiri dari 10 angka dan tercantum pada label tipe produk.

### Indonesia

PT Robert Bosch  
Palma Tower 10th Floor  
Jalan RA Kartini II-S Kaveling 6  
Pondok Pinang, Kebayoran Lama  
Jakarta Selatan 12310  
Tel.: (021) 3005 5800  
Fax: (021) 3005 5801  
E-Mail: [boschpowertools@id.bosch.com](mailto:boschpowertools@id.bosch.com)  
[www.bosch-pt.co.id](http://www.bosch-pt.co.id)

### Alamat layanan lainnya dapat ditemukan di:

[www.bosch-pt.com/serviceaddresses](http://www.bosch-pt.com/serviceaddresses)

## Transpor

Pada baterai-baterai li-ion yang digunakan diterapkan persyaratan terkait peraturan-peraturan tentang bahan-bahan yang berbahaya. Baterai-baterai dapat diangkut oleh penggunanya tanpa pembatasan lebih lanjut di jalan.

Pada pengiriman oleh pihak ketiga (misalnya transportasi udara atau perusahaan ekspedisi) harus ditaati syarat-syarat terkait kemasan dan pemberian tanda. Dalam hal ini, diperlukan konsultasi dengan ahli bahan-bahan berbahaya saat mengatur barang pengiriman.

Kirimkan baterai hanya jika housing-nya tidak rusak. Tutup bagian-bagian yang terbuka dan kemas baterai agar tidak bergerak-gerak di dalam kemasan. Taatilah peraturan-peraturan nasional lainnya yang mungkin lebih rinci yang berlaku di negara Anda.

## Cara membuang



Alat pengukur, aki/baterai, aksesoris dan kemasan harus disortir untuk pendauran ulang yang ramah lingkungan.



Jangan membuang alat pengukur dan baterai bersama dengan sampah rumah tangga!

## Hanya untuk negara Uni Eropa:

Berdasarkan European Directive 2012/19/EU, alat ukur yang tidak dapat digunakan lagi dan berdasarkan European Directive 2006/66/EC, baterai yang aus atau rusak harus dibuang secara terpisah untuk didaur ulang secara ramah lingkungan.

## Baterai:

### Li-Ion:

Perhatikanlah petunjuk-petunjuk dalam bab Transpor (lihat „Transpor“, Halaman 77).

# Tiếng Việt

## Hướng dẫn an toàn



Phải đọc và chú ý mọi hướng dẫn để đảm bảo an toàn và không bị nguy hiểm khi làm việc với dụng cụ đo.

Khi sử dụng dụng cụ đo không phù hợp với các hướng dẫn ở trên, các

thiết bị bảo vệ được tích hợp trong dụng cụ đo có thể bị suy giảm. Không bao giờ được làm cho các dấu hiệu cảnh báo trên dụng cụ đo không thể đọc được. **HÃY BẢO QUẢN CÁN THẬN CÁC HƯỚNG DẪN NÀY VÀ ĐƯA KÈM THEO KHI BẠN CHUYỂN GIAO DỤNG CỤ ĐO.**

- ▶ **Thận trọng** - nếu những thiết bị khác ngoài thiết bị hiệu chỉnh hoặc thiết bị điều khiển được nêu ở đây được sử dụng hoặc các

phương pháp khác được tiến hành, có thể dẫn đến phơi nhiễm phóng xạ nguy hiểm.

- ▶ **Máy đo được dán nhãn cảnh báo laser (được đánh dấu trong mô tả máy đo ở trang đó thì).**
- ▶ **Nếu văn bản của nhãn cảnh báo laser không theo ngôn ngữ của bạn, hãy dán chống nhãn dính được cung cấp kèm theo bằng ngôn ngữ của nước bạn lên trên trước khi sử dụng lần đầu tiên.**



**Không được hướng tia laze vào người hoặc động vật và không được nhìn vào tia laze trực tiếp hoặc phản xạ.** Bởi vì bạn có thể chiếu lóa mắt người, gây tai nạn hoặc gây hỏng mắt.

- ▶ **Nếu tia laze hướng vào mắt, bạn phải nhắm mắt lại và ngay lập tức xoay đầu để tránh tia laze.**
- ▶ **Không thực hiện bất kỳ thay đổi nào ở thiết bị laser.**
- ▶ **Không sử dụng kính nhìn tia laser (Phụ kiện) làm kính bảo vệ.** Kính nhìn tia laser dùng để nhận biết tốt hơn tia laser; tuy nhiên kính không giúp bảo vệ mắt khỏi tia laser.
- ▶ **Không sử dụng kính nhìn tia laser (Phụ kiện) làm kính mát hoặc trong giao thông đường bộ.** Kính nhìn tia laser không chống UV hoàn toàn và giảm thiểu thụ cảm màu sắc.
- ▶ **Chỉ để người có chuyên môn được đào tạo sửa dụng cụ đo và chỉ dùng các phụ tùng gốc để sửa chữa.** Điều này đảm bảo cho sự an toàn của dụng cụ đo được giữ nguyên.
- ▶ **Không để trẻ em sử dụng dụng cụ đo laser khi không có người lớn giám sát.** Có thể vô tình làm lóa mắt người khác hoặc làm lóa mắt chính bản thân.
- ▶ **Không làm việc với dụng cụ đo trong môi trường dễ nổ, mà trong đó có chất lỏng, khí ga hoặc bụi dễ cháy.** Các tia lửa có thể hình thành trong dụng cụ đo và có khả năng làm rác cháy hay ngùn khói.
- ▶ **Không được tháo pin ra.** Nguy cơ bị chập mạch.
- ▶ **Trong trường hợp pin bị hỏng hay sử dụng sai cách, hơi nước có thể bốc ra. Pin có thể cháy hoặc nổ.** Hãy làm cho thông thoáng khí và trong trường hợp bị đau phải nhờ y tế chữa trị. Hơi nước có thể gây ngứa hệ hô hấp.
- ▶ **Khi sử dụng sai hoặc khi pin hỏng, dung dịch dễ cháy từ pin có thể tứa ra. Nếu vô tình chạm phải, hãy xối nước để rửa. Nếu dung dịch vào mắt, cần thêm sự hỗ trợ của y tế. Nếu chất lỏng dính vào mắt, yêu cầu ngay sự giúp đỡ của bác sĩ.** Dung dịch tiết ra từ pin có thể gây ngứa hay bỏng.
- ▶ **Pin có thể bị hư hại bởi các vật dụng nhọn như đinh hay tuốc-nơ-vít hoặc bởi các tác động lực từ bên ngoài.** Nó có thể dẫn tới đoản

mạch nội bộ và làm pin bị cháy, bốc khói, phát nổ hoặc quá nóng.

- ▶ **Khí không sử dụng pin, để cách xa các vật bằng kim loại như kẹp giấy, tiền xu, chìa khoá, đinh, ốc vít hay các đồ vật kim loại nhỏ khác, thứ có thể tạo sự nối tiếp từ một đầu cực với một đầu cực khác.** Sự chập mạch của các đầu cực với nhau có thể gây bỏng hay cháy.
- ▶ **Chỉ sử dụng pin trong các sản phẩm của nhà sản xuất.** Chỉ bằng cách này, pin sẽ được bảo vệ tránh nguy cơ quá tải.
- ▶ **Chỉ được sạc pin lại với bộ nạp điện do nhà sản xuất chỉ định.** Một bộ nạp điện thích hợp cho một bộ pin nguồn có thể gây nguy cơ cháy khi sử dụng để nạp điện cho một bộ pin nguồn khác.



**Bảo vệ pin không để bị làm nóng, ví dụ, chống để lâu dài dưới ánh nắng gay gắt, lửa, chất bẩn, nước, và sự ẩm ướt.** Có nguy cơ nổ và chập mạch.



- ▶ **Trước khi tiến hành bất cứ công việc gì với dụng cụ đo (vd., bảo dưỡng, lắp đặt v.v..) cũng như khi vận chuyển hay lưu kho, tháo pin ra khỏi dụng cụ đo.** Có nguy cơ gây thương tích khi vô tình làm kích hoạt công tắc Tắt/Mở.
- ▶ **Cẩn thận! Nếu sử dụng máy đo với cổng Bluetooth® có thể gây nhiễu các dụng cụ, thiết bị khác cũng như máy bay và dụng cụ y tế (ví dụ: máy tạo nhịp tim, máy trợ thính). Và cũng không thể loại trừ hoàn toàn những tổn hại cho người và động vật ở môi trường trực diện xung quanh.** Không sử dụng máy đo có kết nối Bluetooth® ở gần những thiết bị y tế, trạm xăng, cơ sở hóa học, các khu vực có nguy cơ gây nổ và các khu vực cháy nổ. Không sử dụng máy đo có kết nối Bluetooth® trên máy bay. Tránh để máy hoạt động gần cơ thể trong thời gian dài.

Biểu tượng chữ Bluetooth® cũng như biểu tượng ảnh (các logo) do công ty cổ phần Bluetooth SIG đăng ký nhãn hiệu và sở hữu. Công ty trách nhiệm hữu hạn Robert Bosch Power Tools GmbH đã được cấp phép để sử dụng những biểu tượng chữ/biểu tượng ảnh này với sản phẩm của mình.

- ▶ **Bảo vệ dụng cụ đo, đặc biệt là các khu vực có độ ẩm không khí, nhiệt độ môi trường xung quanh và cảm biến hồng ngoại, hơi ẩm, tuyết, bụi bẩn.** Ống kính thu nhận có thể bị đọng hơi hoặc bị nhiễm bẩn và cho kết quả đo sai. Các điều chỉnh thiết bị sai cũng như các yếu tố ảnh hưởng khác có thể dẫn đến đo sai. Các vật thể có thể được hiển thị với nhiệt độ quá cao hoặc quá thấp, điều này có thể dẫn đến nguy hiểm khi tiếp xúc.
- ▶ **Các phép đo nhiệt độ đúng chỉ có thể thực hiện được nếu độ phát xạ đã đặt và độ phát**

**xạ của vật thể khớp với nhau và nhiệt độ phản xạ chính xác được đặt.** Các vật thể có thể được hiển thị với nhiệt độ quá cao hoặc quá thấp, điều này có thể dẫn đến nguy hiểm khi tiếp xúc.

## Hướng dẫn an toàn khi sử dụng cặp nhiệt điện

- ▶ **Không được sử dụng cặp nhiệt điện trong hệ thống điện có điện.** Nguy hiểm đến tính mạng!
- ▶ **Bảng cách sử dụng một cặp nhiệt điện, có sự tiếp xúc với đối tượng đo.** Do đó, bạn nên nhận thức được những nguy cơ tiềm ẩn từ nhiệt độ, điện áp hoặc các phản ứng hóa học.

## Mô Tả Sản Phẩm và Đặc Tính Kỹ Thuật

Xin lưu ý các hình minh hoạt trong phần trước của hướng dẫn vận hành.

### Sử dụng đúng cách

Dụng cụ đo được thiết kế để đo nhiệt độ bề mặt, nhiệt độ môi trường và độ ẩm tương đối mà không cần tiếp xúc chạm. Nó tính toán nhiệt độ điểm sương và chỉ ra các cấu nhiệt và nguy cơ nấm mốc. Không thể phát hiện bào tử nấm mốc bằng dụng cụ đo. Tuy nhiên, nó có thể giúp xác định sớm các điều kiện có thể thúc đẩy sự phát triển của nấm mốc.

Không được phép dùng thiết bị đo để đo nhiệt độ con người và động vật hoặc dùng cho các mục đích y tế khác.

Dụng cụ đo không thích hợp để đo nhiệt độ bề mặt chất khí.

Việc đo nhiệt độ trong chất lỏng chỉ có thể thực hiện được với sự trợ giúp của cặp nhiệt điện có bán trên thị trường (loại kết nối K), có thể được kết nối với dụng cụ đo thông qua giao diện (25) được cung cấp cho mục đích này.

Với cặp nhiệt điện, các phép đo nhiệt độ bề mặt cũng có thể được thực hiện bằng cách chạm vào bề mặt.





Ánh sáng từ dụng cụ đo này nhằm chiếu sáng vùng làm việc trực tiếp của dụng cụ đo để chụp hình.

Các điểm laser không được sử dụng làm con trỏ laser. Chúng chỉ được sử dụng để đánh dấu bề mặt đo.

Dụng cụ đo phù hợp để sử dụng trong vùng bên ngoài và bên trong.

### Các bộ phận được minh họa

Sự đánh số các biểu trưng của sản phẩm là để tham khảo hình minh họa dụng cụ đo trên trang hình ảnh.

- (1) Nắp che cho giắc cắm/cổng kết nối micro-USB cấp nhiệt điện (Loại K)
- (2) Cửa chiếu lưỡng laser
- (3) Nút mở khóa đầu nối pin/pin/nắp dây pin
- (4) Nút do/Nút bật
- (5) Cảm biến độ ẩm không khí và nhiệt độ môi trường xung quanh
- (6) Mã seri sản xuất
- (7) Nhãn cảnh báo laser
- (8) Cáp Micro-USB
- (9) Bộ nhớ/Nút gửi (Bluetooth®)
- (10) Nút chức năng bên phải
- (11) Phím mũi tên phải
- (12) Phím Bật/tắt
- (13) Phím mũi tên xuống/giảm mức độ phóng đại
- (14) Phím Bật/tắt đèn
- (15) Phím mũi tên trái
- (16) Phím mũi tên lên/tăng mức độ phóng đại
- (17) Nút chức năng bên trái
- (18) Hiển thị
- (19) Nắp dây bảo vệ cảm biến độ ẩm không khí và nhiệt độ môi trường xung quanh
- (20) Nơi gắn đai xách
- (21) Nắp dây bảo vệ ống kính thu hồng ngoại
- (22) Camera
- (23) Ống kính thu hồng ngoại
- (24) Đèn
- (25) Kết nối loại K cho cấp nhiệt điện
- (26) Giắc cắm Micro-USB
- (27) Vỏ đầu nối pin<sup>a)</sup>
- (28) Đầu chụp của đầu nối pin<sup>a)</sup>
- (29) Cổng bộ nguồn
- (30) Pin<sup>a)</sup>
- (31) Nắp dây pin<sup>a)</sup>
- a) Phụ tùng được trình bày hay mô tả không phải là một phần của tiêu chuẩn hàng hóa được giao kèm theo sản phẩm. Bạn có thể tham khảo tổng thể các loại phụ tùng, phụ kiện trong chương trình phụ tùng của chúng tôi.
- Các phần tử hiển thị (xem hình A)**
- (a) Ngày/Giờ (xem „<Thời gian & Ngày tháng>“, Trang 87)
- (b) Khung đo (xem „Bề mặt đo khi đo nhiệt độ bề mặt“, Trang 83)
- (c) Hiển thị trạng thái:
-  Dụng cụ đo sẵn sàng đo, nhấn nút đo (4).
-  Quá trình đo (liên tục) đang diễn ra, laser được bật lên.
-  Kết thúc phép đo, laser được tắt, kết quả đo được cố định.
-  Chế độ nhiệt độ tiếp xúc, laser được bỏ kích hoạt, phép đo chỉ diễn ra qua cấp nhiệt điện.
- (d) Hiển thị mức độ phóng đại (xem „Đặt mức độ phóng đại“, Trang 83)
- (e) Hiển thị Bluetooth® tắt (xem „Truyền dữ liệu qua Bluetooth®“, Trang 86)
- (f) Bộ Chỉ Báo Tình Trạng Pin
- (g) Hiển thị chức năng/Giá trị đo được độ ẩm tương đối
- (h) Hiển thị chức năng/Giá trị đo được nhiệt độ môi trường
- (i) Hiển thị chức năng/Kết quả nhiệt độ điểm sương
- (j) Giá trị đo tối thiểu/tối đa Nhiệt độ bề mặt trong quá trình đo
- (k) Thang đo kết quả
- (l) Biểu tượng menu
- (m) Hiển thị Cảnh báo nhiệt độ bề mặt (xem „Cảnh báo nhiệt độ bề mặt“, Trang 85)
- (n) Giá trị đo được
- (o) Chế độ hiện tại
- (p) Đánh dấu giá trị đo được hoặc kết quả (tùy thuộc vào chế độ đã chọn)
- (q) Biểu tượng Bộ sưu tập
- (r) Hiển thị chức năng/Giá trị đo Nhiệt độ trung bình
- (s) Hiển thị chức năng/Giá trị đo Nhiệt độ tiếp xúc
- (t) Hiển thị Độ phát xạ/nhiệt độ phản xạ
- (u) Nhiệt độ bên ngoài được đặt (Chế độ cấu nhiệt)
- (v) Hiển thị  $f_{RS}$ -Giá trị với dung sai (Chế độ cấu nhiệt)

## Thông số kỹ thuật

Máy dò nhiệt	GIS 1000 C	GIS 1000 C
Mã số máy	<b>3 601 K83 3..</b>	<b>3 601 K83 371</b>
Phạm vi làm việc	0,1–5 m	0,1–5 m
Phạm vi đo		
– Nhiệt độ bề mặt	–40 ... +1000 °C	–40 ... +1000 °C

Máy dò nhiệt	GIS 1000 C	GIS 1000 C
– Nhiệt độ tiếp xúc	–40 ... +1000 °C	–40 ... +1000 °C
– Nhiệt độ môi trường	–10 ... +50 °C	–10 ... +50 °C
– Độ ẩm tương đối	0 ... 100 %	0 ... 100 %
<b>Độ đo chính xác<sup>A)</sup></b>		
<b>Nhiệt độ bề mặt<sup>B)</sup></b>		
–40 ... –20,1 °C	±2,5 °C	±2,5 °C
–20 ... –0,1 °C	±1,5 °C	±1,5 °C
<b>0 ... +100 °C</b>	<b>±1 °C</b>	<b>±1 °C</b>
+100 °C ... +400 °C	±1 %	±1 %
> +400 °C	±2 %	±2 %
<b>Nhiệt độ môi trường</b>	±1 °C	±1 °C
<b>Độ ẩm tương đối<sup>C)</sup></b>		
< 20 %	±3 %	±3 %
<b>20 ... 60 %</b>	<b>±2 %</b>	<b>±2 %</b>
60 ... 90 %	±3 %	±3 %
Quang học (Tỷ lệ khoảng cách đo : điểm đo) <sup>D)E)</sup>	50 : 1	50 : 1
Cấp độ Laser	2	2
Loại Laser	635 nm, < 1 mW	635 nm, < 1 mW
Phân kỳ (Góc đầu)	< 1,5 mrad	< 1,5 mrad
Chiều cao ứng dụng tối đa qua chiều cao tham chiếu	2000 m	2000 m
Mức độ bắn theo IEC 61010-1	2 <sup>F)</sup>	2 <sup>F)</sup>
Độ ẩm tương đối tối đa.	90 %	90 %
Pin (kiềm-mangan)	4 × 1,5 V LR6 (AA) (với bộ thích nghi pin)	4 × 1,5 V LR6 (AA)
Pin hợp khối (Li-Ion)	10,8 V/12 V	–
Tuổi thọ pin		
– Pin (kiềm-mangan)	3 h	3 h
– Pin hợp khối (Li-Ion) <sup>G)</sup>	10 h	–
Số lượng hình ảnh trong bộ nhớ hình ảnh trong	> 200	> 200
Bluetooth® (Classic và Low Energy)	4.2 <sup>H)</sup>	4.2 <sup>H)</sup>
Dải tần số hoạt động	2402–2480 MHz	2402–2480 MHz
Năng suất truyền tối đa	2,5 mW	2,5 mW
Cổng kết nối USB	2.0	2.0
Trọng lượng theo EPTA-Procedure 01:2014 <sup>G)</sup>	0,56–0,77 kg	0,51 kg
Kích thước (Dài × Rộng × Cao)	136 × 89 × 214 mm	136 × 89 × 214 mm
Các điều kiện xung quanh		
– Nhiệt độ môi trường được khuyến nghị khi sạc	0 °C ... +35 °C	–
– Nhiệt độ môi trường cho phép khi vận hành	–10 °C ... +50 °C	–10 °C ... +50 °C
– Nhiệt độ môi trường cho phép khi lưu trữ không có pin	–20 °C ... +70 °C	–20 °C ... +70 °C
– Nhiệt độ môi trường cho phép khi lưu trữ có pin	–20 °C ... +50 °C	–
Pin được khuyến dùng	GBA 10,8V... GBA 12V...	–



**Máy đo nhiệt****GIS 1000 C****GIS 1000 C**

Thiết bị nạp được giới thiệu

GAL 12...

-

- A) cộng với độ lệch phụ thuộc vào ứng dụng (ví dụ: phản xạ, khoảng cách, nhiệt độ môi trường)
- B) ở nhiệt độ môi trường xung quanh là +20 °C ... +23 °C, độ phát xạ > 0,999, khoảng cách đo là 0,3 m, khẩu độ là 60 mm
- C) khi nhiệt độ môi trường xung quanh là +15 °C ... +40 °C
- D) Thông số kỹ thuật phù hợp với VDI/VDE 3511 Tờ 4.3 (Ngày phát hành Tháng Bảy năm 2005); áp dụng cho 90 % tín hiệu đo.  
Đo ngoài phạm vi các độ lớn mô tả trong Dữ liệu Kỹ thuật có thể dẫn đến các kết quả đo sai lệch.
- E) viên dẫn phép đo hồng ngoại, xem biểu đồ:

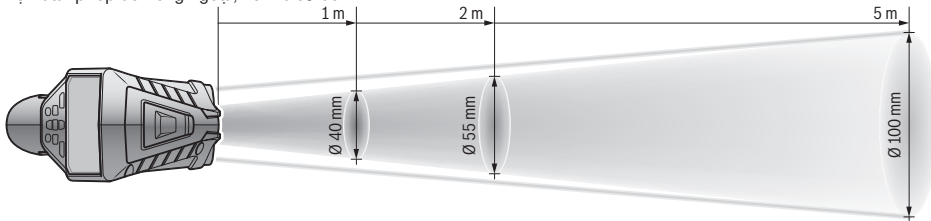

- F) Chỉ có chất bẩn không dẫn xuất hiện, nhưng đôi khi độ dẫn điện tạm thời gây ra do ngưng tụ.
- G) tùy vào loại pin lắp đang sử dụng
- H) Với các thiết bị Bluetooth® tiêu thụ năng lượng thấp, tùy thuộc vào model và hệ điều hành, có thể không cần các thiết lập kết nối. Các thiết bị Bluetooth® phải có tính năng hỗ trợ SPP profile.
- Số xêri (6) đều được ghi trên nhãn mác, để dễ dàng nhận dạng loại máy đo.

## Lắp ráp

### Nguồn năng lượng cho dụng cụ đo

Dụng cụ đo có thể hoạt động bằng các loại pin thông thường hay với pin hợp khối Li-lon hiệu Bosch.

Mã số máy **3 601 K83 371**: Dụng cụ đo chỉ có thể hoạt động với pin tiêu chuẩn.

**Hoạt động bằng pin thường (không áp dụng cho máy có mã số 3 601 K83 371) (xem hình B)**  
Pin phải được lắp vào đầu nối pin.

- **Bộ thích nghi pin hoàn toàn dùng để sử dụng trong các dụng cụ đo của Bosch và không được phép sử dụng cùng với dụng cụ điện tử.**

Để lắp pin, hãy đẩy vỏ (27) của đầu nối pin vào khe pin (29). Hãy cài pin vào vỏ theo hình minh họa trên đầu chụp (28). Đẩy đầu chụp lên trên vô đến khi nó được gài vào khớp.



Để tháo pin hãy nhấn phím mở khóa (3) của đầu chụp (28) và kéo đầu chụp ra. Đảm bảo là pin không bị rơi xuống. Hãy giữ máy đo để khe pin (29) hướng lên trên. Tháo pin ra. Để tháo vỏ nằm bên trong (27) ra khỏi khe pin, nắm chặt vào vỏ và kéo nó ra với một lực vừa phải về một phía của máy đo.

Luôn luôn thay tất cả pin cùng một lần. Chỉ sử dụng pin cùng một hiệu và có cùng một điện dung.

- **Tháo ắc quy ra khỏi dụng cụ đo nếu bạn không muốn sử dụng thiết bị trong thời gian**

dài. Pin có thể hư mòn sau thời gian bảo quản lâu trong dụng cụ đo và tự xả điện.

### Hoạt động bằng pin thường (không áp dụng cho máy có mã số 3 601 K83 371) (xem hình C)

- **Chỉ sử dụng bộ sạc được để cập trong dữ liệu kỹ thuật.** Chỉ những thiết bị nạp này phù hợp cho máy đo của bạn có sử dụng pin Li-lon.

**Hướng dẫn:** Việc sử dụng pin không phù hợp với dụng cụ đo có thể dẫn đến lỗi chức năng hoặc gây hỏng dụng cụ đo.

**Hướng dẫn:** Pin đã được sạc một phần. Để đảm bảo hiệu suất tuyệt đối của pin, nên sạc đầy cho lần sử dụng đầu tiên.

Pin Li-lon hợp khối có thể nạp điện bất cứ lúc nào mà không làm giảm tuổi thọ của pin. Sự gián đoạn trong quá trình nạp điện không làm hư hại pin hợp khối.

Để lắp pin đã nạp hãy (30) đẩy nó vào ngăn pin (29), cho đến khi khớp vào và nằm ngang bằng với tay cầm của máy đo.

Để tháo pin (30) hãy nhấn Phím mở khóa (3) và kéo pin ra khỏi khe pin (29). **Không dùng sức.**

### Hoạt động bằng pin thường (3 601 K83 371) (xem hình D)

Để mở nắp đầy pin (31) hãy nhấn phím mở khóa (3) và tháo nắp đầy pin ra.

Xin hãy lưu ý lắp tương ứng đúng cực pin theo hình minh họa trên nắp đầy pin.

Lắp lại nắp đầy pin (31) và để nó khớp vào vị trí.

Luôn luôn thay tất cả pin cùng một lần. Chỉ sử dụng pin cùng một hiệu và có cùng một điện dung.

- ▶ **Tháo ốc quy ra khỏi dụng cụ đo nếu bạn không muốn sử dụng thiết bị trong thời gian dài.** Pin có thể hư mòn sau thời gian bảo quản lâu trong dụng cụ đo và tự xả điện.

## Vận Hành

### Bắt Đầu Vận Hành

- ▶ **Bảo vệ dụng cụ đo tránh khỏi ẩm ướt và không để bức xạ mặt trời chiếu trực tiếp vào.**
- ▶ **Không cho dụng cụ đo tiếp xúc với nhiệt độ khắc nghiệt hoặc dao động nhiệt độ.** Không để nó trong chế độ tự động quá lâu. Điều chỉnh nhiệt độ cho dụng cụ đo khi có sự dao động nhiệt độ lớn, trước khi bạn đưa nó vào vận hành. Trong trường hợp ở trạng thái nhiệt độ cực độ hay nhiệt độ thay đổi thái quá, sự chính xác của dụng cụ đo có thể bị hư hỏng.
- ▶ **Chú ý tuân thủ chính xác các yếu tố thích nghi khí hậu của dụng cụ đo.** Trong trường hợp nhiệt độ dao động mạnh, thời gian thích nghi có thể lên đến **60** phút. Đây có thể là trường hợp, ví dụ, nếu bạn cất dụng cụ đo trong một chiếc xe lạnh và sau đó thực hiện phép đo trong một tòa nhà ấm áp.
- ▶ **Tránh va chạm mạnh hoặc làm rơi dụng cụ đo.** Sau khi chịu những tác động bên ngoài nặng nề và có các bất thường về chức năng, bạn nên kiểm tra dụng cụ đo tại trung tâm dịch vụ có thẩm quyền của **Bosch**.

### Bật Mở và Tắt

Tháo nắp dây bảo vệ (21) khỏi ống kính thu hồng ngoại (23) và nắp dây bảo vệ (19) khỏi cảm biến độ ẩm và nhiệt độ môi trường (5). **Trong khi làm việc, hãy đảm bảo rằng camera (22), ống kính thu (23) và cảm biến (5) không bị đóng hoặc bị che, nếu không sẽ không thể thực hiện các phép đo chính xác.**

Để **bật** dụng cụ đo, bạn hãy ấn phím **bật/tắt (12)** hoặc phím **do (4)**. Trên màn hình (18) xuất hiện một trình tự khởi động. Sau trình tự khởi động, dụng cụ đo ở chế độ làm việc được lưu khi tắt lần cuối. Laser chưa được bật.

Sau trình tự khởi động, menu **<Thiết bị>**, mà qua đó bạn có thể thiết lập các cài đặt của dụng cụ đo như ngôn ngữ hiển thị chỉ xuất hiện trong lần chạy đầu (xem „Menu phụ **<Thiết bị>**“, Trang 87). Xác nhận cài đặt đã chọn bằng cách nhấn phím chức năng bên phải (10). Tất cả các cài đặt cũng có thể được thay đổi sau này trong menu phụ **<Thiết bị>**.

- ▶ **Không cho phép dụng cụ đo đang bật một cách không kiểm soát và hãy tắt dụng cụ đo sau khi sử dụng.** Tia Laser có thể chiếu vào những người khác.
- ▶ **Không được chĩa luồng laze vào con người hay động vật và không được tự chỉnh bạn**

**nhìn vào luồng laze, ngay cả khi từ một khoảng cách lớn.**

Trong cài đặt gốc, độ sáng của đèn màn hình giảm 30 giây sau mỗi lần nhấn phím để tiết kiệm năng lượng. Khi bạn nhấn bất kỳ phím nào, đèn màn hình sẽ được bật lại ở mức tối đa. Bạn có thể thay đổi thời gian chiếu sáng (xem „**<T.gian h.thị đèn>**“, Trang 87) này trong menu **<T.gian h.thị đèn>**.

Để **tắt** máy, bạn hãy ấn nút **bật/tắt (12)**. Dụng cụ đo lưu chế độ làm việc hiện tại và các cài đặt, sau đó tắt. Đặt nắp dây bảo vệ (21) trở lại ống kính thu (23) và nắp dây bảo vệ (19) trên cảm biến độ ẩm và nhiệt độ môi trường xung quanh (5).

Không tắt dụng cụ đo bằng cách tháo pin sạch hoặc đầu nối pin, vì điều này có thể làm hỏng bộ nhớ trong trường hợp xấu nhất.

Trong menu chính, bạn có thể đặt xem và sau khoảng thời gian nào dụng cụ đo tự động tắt mà không cần nhấn phím/đo (xem „**<Thời gian tắt>**“, Trang 87). Chế độ hoạt động hiện tại và cài đặt cũng được lưu khi thiết bị tự động tắt.

Nếu pin hoặc dụng cụ đo nằm ngoài nhiệt độ làm việc được chỉ định trong dữ liệu kỹ thuật, dụng cụ đo sẽ tự động tắt sau khi có cảnh báo ngắn (xem „**Lỗi – Nguyên nhân và biện pháp khắc phục**“, Trang 87). Để dụng cụ đo nguội bớt rồi bật lại.

### Chuẩn bị đo

#### Đặt độ phát xạ cho các phép đo nhiệt độ bề mặt

Để xác định nhiệt độ bề mặt, bức xạ nhiệt hồng ngoại tự nhiên sẽ được đo không tiếp xúc, phát tới đối tượng mục tiêu. Để có các phép đo chính xác, phải kiểm tra độ phát xạ đã được điều chỉnh tại máy đo **trước mỗi phép đo** và có thể điều chỉnh tại đối tượng đo nếu có thể.

Các độ phát xạ đặt trước trong dụng cụ đo là các giá trị tiêu chuẩn.

Bạn có thể chọn một trong nhiều độ phát xạ hoặc nhập một giá trị số chính xác. Hãy điều chỉnh độ phát xạ mong muốn qua menu **<Đo>** → **<Độ phát xạ>** (xem „**<Menu chính>**“, Trang 86).

- ▶ **Các phép đo nhiệt độ đúng chỉ có thể thực hiện được nếu độ phát xạ đã đặt và độ phát xạ của vật thể khớp với nhau và nhiệt độ phản xạ chính xác được đặt.** Các vật thể có thể được hiển thị với nhiệt độ quá cao hoặc quá thấp, điều này có thể dẫn đến nguy hiểm khi tiếp xúc.

Độ phát xạ càng thấp, ảnh hưởng của nhiệt độ phản xạ đến kết quả đo càng lớn. Do đó, nếu bạn thay đổi độ phát xạ, hãy luôn điều chỉnh nhiệt độ phản xạ. Hãy điều chỉnh độ phát xạ mong muốn qua menu **<Đo>** → **<Nhiệt độ phản xạ>** (xem „**<Menu chính>**“, Trang 86).

Nếu có một số đối tượng đo có độ phát xạ khác nhau trong bề mặt đo được đánh dấu bằng laser, thì phép đo nhiệt độ có thể bị sai lệch.

### Bề mặt đo khi đo nhiệt độ bề mặt

Các điểm laser được tạo ra bởi dụng cụ đo phân định bề mặt đo tròn ở bên ngoài. Giá trị đo nhiệt độ được hiển thị cho biết nhiệt độ bề mặt trung bình trong vùng này.

#### ► Không được chia luồng laser vào con người hay động vật và không được tự chính bạn nhìn vào luồng laser, ngay cả khi từ một khoảng cách lớn.

Khoảng cách giữa các điểm laser và do đó kích thước của bề mặt đo tăng lên cùng với khoảng cách giữa dụng cụ đo và đối tượng đo.

Nếu các điểm laser khó nhận biết, bạn có thể bật <Khung đo lường> (b) lên trên màn hình (xem „<Khung đo lường>“, Trang 87). Khung đo có thể được sử dụng như một chỉ báo cho bề mặt đo và được sử dụng để định hướng tốt hơn. Tùy thuộc vào khoảng cách đo, khung đo có thể lệch khỏi bề mặt đo. Khu vực giữa các điểm laser là quyết định cho phép đo.

#### Ghi chú về các điều kiện đo

Các bề mặt phản chiếu lóa, sáng chói hoặc trong suốt (ví dụ: gạch lát, mặt trước bằng thép không gỉ hoặc nhôm) có thể ảnh hưởng đến phép đo nhiệt độ bề mặt. Hãy dán mặt đo lại bằng băng dính xin màu có thể dẫn nhiệt tốt nếu cần thiết. Hãy để băng dính cân bằng trên bề mặt một lát.

Về mặt nguyên tắc, không thể đo bằng vật liệu trong suốt.

Các kết quả đo sẽ càng chính xác và đáng tin cậy khi các điều kiện đo tốt hơn và ổn định hơn.

Cảm biến độ ẩm không khí và nhiệt độ môi trường xung quanh (5) có thể tiếp xúc với các chất ô nhiễm hóa học như hơi từ sơn hoặc màu có thể bị hỏng. Phép đo nhiệt độ bằng hồng ngoại có thể bị ảnh hưởng xấu bởi khói, hơi hoặc không khí bụi bặm.

Cho nên, bạn cần thông khí trước khi đo phòng này, đặc biệt khi không khí bị ô nhiễm hoặc rất ẩm thấp. Ví dụ không đo trong phòng tắm ngay sau khi tắm.

Hãy để căn phòng cân bằng sau khi thông khí, cho tới khi phòng đạt nhiệt độ thông thường.

Nhiệt độ môi trường và độ ẩm tương đối được đo trực tiếp trên dụng cụ đo trên cảm biến độ ẩm và nhiệt độ môi trường (5). Để có kết quả có ý nghĩa, không cầm dụng cụ đo ngay phía trên hoặc bên cạnh các nguồn gây nhiễu như lò sưởi hoặc chất lỏng hồ. Không che cảm biến (5) trong bất kỳ trường hợp nào.

Chú ý tới góc đo thuận tiện tại các diện tích phản chiếu sao cho bức xạ nhiệt phản chiếu của vật thể khác không làm sai lệch kết quả đo. Ví dụ, khi đo mà theo chiều dọc từ phía trước, hiện tượng phản chiếu nhiệt độ cơ thể của bạn có thể gây nhiễu đến phép đo.

### Đặt mức độ phóng đại

Phần hình ảnh trên màn hình có thể được hiển thị ở 3 mức độ phóng đại khác nhau cho các phép đo liên tục và khi phát lại ảnh chụp màn hình đã lưu: 0,5 m, 2 m và 5 m.

Các mức độ phóng đại được tối ưu hóa cho khoảng cách tương ứng giữa dụng cụ đo và đối tượng đo: Với khoảng cách đo là 2 m, mức độ phóng đại „2 m“ hiển thị phần hình ảnh (thông thường) tốt nhất.

Mức độ phóng đại hiện tại xuất hiện trên màn hình (d). Để tăng mức độ phóng đại, hãy nhấn nút mũi tên tăng mức độ phóng đại (16), để giảm, nhấn nút mũi tên giảm mức độ phóng đại (13).

Do thị sai, khung đo (b) chỉ tương ứng với phạm vi đo nếu mức phóng đại đã chọn tương ứng với khoảng cách đo thực tế.

### Chiếu sáng bề mặt đo

Khi đo trong vùng tối, bạn có thể bật đèn (24) để cải thiện hiển thị nội dung màn hình. Điều này có thể giúp bạn có kết quả tốt hơn khi lưu ảnh chụp màn hình.

Để bật hoặc tắt đèn (24) hãy nhấn nút (14).

Để tiết kiệm năng lượng, đèn sẽ tự động tắt khi giảm độ sáng của đèn màn hình. Bạn có thể thay đổi thời gian chiếu sáng này trong menu <T.gian h.thị đèn> (xem „<T.gian h.thị đèn>“, Trang 87). Khi đèn màn hình được bật lại, đèn sẽ không tự động bật.

Nếu mức sạc của pin nằm trong khoảng giới hạn, đèn sẽ không hoạt động để tiết kiệm năng lượng.

### Các chức năng đo

#### Chuyển đổi giữa các chế độ riêng lẻ

Sử dụng các phím mũi tên phải (11) hoặc trái (15) để chọn chế độ mong muốn (chế độ được hiển thị kèm theo giải thích ngắn gọn). Để ẩn lời giải thích sớm, hãy nhấn nút lưu (9). Để ẩn phần giải thích và ngay lập tức bắt đầu một phép đo, hãy nhấn nút đo (4).

#### Chế độ nhiệt độ bề mặt

Trong chế độ nhiệt độ bề mặt, nhiệt độ bề mặt của đối tượng đo được đo.

Trong chế độ này, bạn có thể kiểm tra thiết bị sưởi ấm hoặc tìm các bộ phận máy quá nóng.

Bắt đầu đo bằng cách nhấn nút đo (4). Các giá trị đo được hiển thị trên màn hình được cập nhật liên tục. Ngay sau khi bạn nhấn nút đo (4) phép đo sẽ bị gián đoạn và laser được tắt. Kết quả đo cuối cùng được cố định trên màn hình (n). Nhiệt độ bề mặt đo được cuối cùng được hiển thị với đánh dấu (p) trên thang kết quả (k).

Giá trị nhiệt độ tối thiểu và tối đa của quá trình đo xuất hiện trên màn hình (j), ngay khi chênh lệch giữa các giá trị đo được lớn hơn 3 °C. Điều này cho

phép bạn xem giá trị đo hiện tại cao như thế nào so với nhiệt độ đã đo.

### Chế độ cấu nhiệt

Dụng cụ đo có thể giúp bạn tìm các cấu nhiệt (xem „Cấu nhiệt“, Trang 88).

Trước khi bắt đầu phép đo, nhiệt độ bên ngoài trước tiên phải được cài đặt. Để làm việc này, hãy mở <Menu chính> trên (xem „Điều hướng trên <Menu chính>“, Trang 86). Chọn menu phụ <Cấu nhiệt> và đặt nhiệt độ bên ngoài hiện tại. Bắt đầu đo bằng cách nhấn nút đo (4).

Xem xét nhiệt độ môi trường bên trong và nhiệt độ bên ngoài để xác định xem nhiệt độ bề mặt có đáp ứng các yêu cầu tối thiểu về bảo vệ nhiệt hay không. Nếu không đáp ứng yêu cầu tối thiểu, giá thiết là có khuyết tật kết cấu và có cảnh báo đối với cấu nhiệt.

Sau khi quá trình đo hoàn tất, nhiệt độ bề mặt của mục tiêu cuối cùng được cố định trên màn hình (n) và nhiệt độ môi trường được cố định trên màn hình (h). Giá trị  $f_{RSI}$ -được tính toán (xem „Cấu nhiệt“, Trang 88) và dung sai ước tính của nó được hiển thị trên màn hình (v).

Dụng cụ đo lường hiển thị giải thích các giá trị với đánh dấu (p) trên thang kết quả (k):

- Đánh dấu (p) trong vùng màu xanh lá cây (giá trị  $f_{RSI}$ -trên 0,7, bao gồm cả dung sai): không có cấu nhiệt
- Đánh dấu (p) trong vùng màu vàng (giá trị  $f_{RSI}$ -trong vùng giới hạn 0,7): có thể có cấu nhiệt trong vùng đo. Phép đo phải được lặp lại trong các điều kiện môi trường xung quanh thuận lợi hơn (ví dụ: khi nhiệt độ bên ngoài thấp hơn).
- Đánh dấu (p) trong vùng màu đỏ (giá trị  $f_{RSI}$ -dưới 0,7, bao gồm cả dung sai): Có thể có một cấu nhiệt trong vùng đo.

### Chế độ điểm sương

Thiết bị đo có thể giúp bạn tìm ra những khu vực có nguy cơ bị nấm mốc.

Ở chế độ này từ nhiệt độ môi trường xung quanh và độ ẩm tương đối (xem „Độ ẩm tương đối“, Trang 88) có thể tính toán được nhiệt độ điểm sương (xem „Nhiệt độ điểm sương“, Trang 89). Nhiệt độ điểm sương được so sánh với nhiệt độ bề mặt đo được và được diễn giải về nguy cơ hình thành nấm mốc.

Lưu ý rằng kết quả đo chỉ từng là thể hiện một ảnh chụp nhanh dựa trên các điều kiện môi trường hiện tại. Không thể dự báo cho các điều kiện môi trường có thể thay đổi. Nếu kết quả đo là quan trọng, bạn nên lặp lại phép đo vào các thời điểm khác nhau và trong các điều kiện khác nhau.

Bắt đầu đo bằng cách nhấn nút đo (4). Các giá trị đo được hiển thị trên màn hình được cập nhật liên tục.

Sau khi quá trình đo hoàn tất, nhiệt độ bề mặt của mục tiêu cuối cùng được cố định trên màn hình (n), nhiệt độ môi trường (h) và độ ẩm tương đối được cố định trên màn hình (g). Nhiệt độ điểm sương tính toán được hiển thị trong (i).

Dụng cụ đo giúp giải thích các giá trị có đánh dấu (p) trên thang kết quả (k):

- Đánh dấu (p) trong vùng màu xanh lá cây: Không có nguy cơ nấm mốc trong điều kiện hiện tại.
- Đánh dấu (p) trong vùng màu vàng: Các giá trị nằm trong phạm vi giới hạn; chú ý đến nhiệt độ phòng, cấu nhiệt và độ ẩm và lặp lại phép đo trong khoảng thời gian nếu cần.
- Đánh dấu (p) trong vùng màu đỏ: Tăng nguy cơ nấm mốc do độ ẩm quá cao hoặc nhiệt độ bề mặt gần với phạm vi nhiệt độ điểm sương. Giá trị đáng chú ý sẽ nhấp nháy trên màn hình.

Nguy cơ nấm mốc được cảnh báo khi nhiệt độ bề mặt bằng 80 % nhiệt độ điểm sương.

**Lưu ý:** Không thể phát hiện bào tử nấm mốc bằng dụng cụ đo. Điều đó chỉ cho thấy rằng nếu các điều kiện vẫn như cũ, nấm mốc có thể hình thành.

### Chế độ nhiệt độ tiếp xúc

Khi đo nhiệt độ tiếp xúc, nhiệt độ của một đối tượng có thể được đo trực tiếp bằng cặp nhiệt điện đã che chắn loại K có bán trên thị trường.

Đo nhiệt độ tiếp xúc có thể là một bổ sung hữu ích cho phép đo nhiệt độ không tiếp xúc chạm. Ứng dụng này đặc biệt hữu ích trong các tình huống mà phép đo hồng ngoại có những nhược điểm cố hữu, ví dụ: khi đo nhiệt độ trong môi trường, chất lỏng, luồng không khí hoặc bề mặt có độ phát xạ thấp (kim loại trần).

Có các dạng hình học của đầu dò được tối ưu hóa đặc biệt cho các ứng dụng khác nhau trong chất lỏng, dòng khí hoặc trên các bề mặt, cho phép đo chính xác khi sử dụng một đầu dò thích hợp.

Đọc và làm theo bất kỳ hướng dẫn nào từ nhà sản xuất cặp nhiệt điện.

Việc sử dụng cặp nhiệt điện yêu cầu tiếp xúc trực tiếp với đối tượng đo. Chú ý đến những nguy hiểm tiềm ẩn và các hướng dẫn an toàn.

Trong chế độ này, chỉ nhiệt độ của cảm biến nhiệt độ được đo; các biến đo lường khác được loại trừ ở đây.

**Lưu ý:** Chỉ sử dụng cặp nhiệt điện đã che chắn loại K. Nếu các loại cặp nhiệt điện khác được kết nối, kết quả đo có thể không chính xác.

Mở nắp (1) và kết nối cặp nhiệt điện với đầu nối (25).

Ngay sau khi kết nối cặp nhiệt điện, thông báo sẽ xuất hiện (n) trên màn hình. Giá trị đo trên màn hình được cập nhật liên tục. Không phải nhấn nút Đo (4) để thực hiện phép đo ở chế độ này và laser được tắt. Để có kết quả đáng tin cậy, hãy đợi cho đến khi giá trị đo không còn thay đổi. Tùy thuộc vào

thiết kế của cặp nhiệt điện, quá trình này có thể mất vài phút.

Tuy nhiên, ngoài nhiệt độ bề mặt, nhiệt độ tiếp xúc cũng có thể được đo ở mỗi chế độ. Sau đó, giá trị đo được hiển thị ở vị trí khác (**s**). Tuy nhiên, nhiệt độ bề mặt (**n**) vẫn được sử dụng để xác định cầu nhiệt và nguy cơ nấm mốc.

Nếu tháo cặp nhiệt điện, hiển thị chức năng sẽ tắt (**s**) trên màn hình. Sau khi tháo cặp nhiệt điện, hãy đóng nắp (**1**) lại.

### Chế độ người dùng

Ở chế độ người dùng, nhiệt độ bề mặt và môi trường xung quanh cũng như độ ẩm tương đối được đo. Từ đó, nhiệt độ điểm sương và nhiệt độ trung bình (giá trị trung bình của nhiệt độ bề mặt trong thời gian đo) được tính.

Nếu cần, bạn có thể ẩn các giá trị sau khỏi màn hình: nhiệt độ trung bình, độ ẩm tương đối, nhiệt độ môi trường và nhiệt độ điểm sương.

Để làm việc này, hãy mở **<Menu chính>** trên (xem „Điều hướng trên **<Menu chính>**“, Trang 86).

Chọn menu phụ **<Chế độ người dùng>**. Ở đây hiển thị **<Nhiệt độ tr. bình>**, **<Độ ẩm không khí>**, **<Nhiệt độ phòng>** và **<Điểm ngưng tụ>** có thể được bật và tắt.

Đối với các phép đo nhiệt độ bề mặt, bạn có thể chọn xem các giá trị tối thiểu và tối đa (**j**) của thang đo kết quả (**k**) nên được điều chỉnh tự động hoặc đặt thủ công. Để thực hiện việc này, hãy chuyển đến menu **<Chế độ người dùng>** rồi menu con **<Phạm vi đo>**.

- Chọn **<tự động>**, nếu các giá trị (**j**) sẽ được xác định tự động như trong chế độ nhiệt độ bề mặt. Giá trị nhiệt độ tối thiểu và tối đa của quá trình đo xuất hiện trên màn hình (**j**), ngay khi chênh lệch giữa các giá trị đo được lớn hơn 3 °C.
- Chọn **<đã được thiết lập sơ bộ>**, để đặt các giá trị theo cách thủ công. Đặt các giá trị mong muốn trong menu **<Chế độ người dùng>** dưới **<G.hạn dải nhiệt thấp>** và **<G.hạn dải nhiệt cao>**. Trên màn hình (**j**) xuất hiện các giá trị tối thiểu và tối đa được thiết lập thủ công. Để bạn có thể so sánh ảnh chụp màn hình của các phép đo khác nhau bằng cách sử dụng đánh dấu (**p**).

### Cảnh báo nhiệt độ bề mặt

Cảnh báo nhiệt độ bề mặt có thể được sử dụng ở mọi chế độ ngoại trừ đo nhiệt độ tiếp xúc. Bạn có thể đặt nhiệt độ tối thiểu và tối đa.

Nếu **nhiệt độ tối thiểu** bị vượt giới hạn, hiển thị cảnh báo nhiệt độ nhấp nháy (**m**) màu xanh dương và tín hiệu cảnh báo sẽ phát ra khi tín hiệu âm thanh được bật.

Nếu **nhiệt độ tối đa** bị vượt quá giới hạn, hiển thị cảnh báo nhiệt độ nhấp nháy (**m**) màu đỏ và tín hiệu cảnh báo sẽ phát ra khi tín hiệu âm thanh được bật.

Để sử dụng cảnh báo nhiệt độ bề mặt, hãy mở **<Menu chính>** trên (xem „Điều hướng trên **<Menu chính>**“, Trang 86).

- Chọn menu phụ **<Bảo động>**.
- Đặt **<Âm báo t.thiểu/t.đ>** thành **<bật>**.
- Đặt nhiệt độ tối thiểu dưới **<Bảo động tối thiểu>**.
- Đặt nhiệt độ tối đa dưới **<Bảo động tối đa>**.

Nhiệt độ tối thiểu và tối đa cũng được lưu nếu bạn đặt cảnh báo thành **<tắt>**.

### Truyền dữ liệu

#### Lưu / hiển thị / gửi kết quả đo

Sau khi kết thúc phép đo, biểu tượng bộ nhớ xuất hiện trên màn hình để cho biết bạn có thể lưu kết quả đo. Để làm việc này, hãy nhấn nút lưu / gửi (**9**). Kết quả đo được lưu dưới dạng tệp JPG (ảnh chụp màn hình cố định).



- Để **hiển thị** ảnh chụp màn hình đã lưu, hãy nhấn phím chức năng bên trái (**17**) bên dưới biểu tượng bộ sưu tập (**q**). Trên màn hình xuất hiện ảnh đã được lưu gần nhất.

- Nhấn các nút mũi tên phải (**11**) hoặc trái (**15**), để chuyển đổi giữa các ảnh chụp màn hình đã lưu.

- Để gửi kết quả đo được hiển thị qua **Bluetooth®** hãy nhấn nút lưu / gửi (**9**). Nếu kết nối **Bluetooth®** chưa được bật (xem „Truyền dữ liệu qua **Bluetooth®**“, Trang 86), nó có thể được kích hoạt bằng cách nhấn nút lưu / gửi.



- Để **xóa** ảnh chụp màn hình đã hiển thị, hãy nhấn phím chức năng bên phải (**10**) dưới biểu tượng thùng rác.



- Để xác nhận việc xóa, bấm phím chức năng bên trái (**17**) dưới biểu tượng lưỡi câu.



- Để hủy quá trình xóa, nhấn phím chức năng bên phải (**10**) dưới biểu tượng chữ thập.



- Để thoát khỏi chế độ xem thư viện và quay lại chế độ đo, hãy bấm phím chức năng bên trái (**17**) dưới biểu tượng quay lại.

Bạn cũng có thể xóa tất cả các tệp đã lưu cùng một lúc (xem „**<Xóa tất cả hình ảnh>**“, Trang 87).

### Truyền dữ liệu qua giao diện USB

Mở nắp giắc cắm micro USB (**1**). Kết nối giắc cắm micro USB (**26**) của dụng cụ đo với máy tính của bạn bằng cáp micro USB (**8**) đi kèm.

Bây giờ bật dụng cụ đo bằng nút bật/tắt (**12**).

Mở trình duyệt tệp trên máy tính của bạn và chọn ổ đĩa **GIS 1000 C**. Các tệp đã lưu có thể được sao

chép từ bộ nhớ trong của dụng cụ đo, chuyển sang máy tính của bạn hoặc xóa.

Ngay sau khi bạn kết thúc quá trình mong muốn, hãy ngắt kết nối ổ đĩa khỏi máy tính theo mặc định rồi tắt dụng cụ đo một lần nữa bằng nút bật / tắt (12).

**Chú ý:** Luôn thoát khỏi ổ đĩa từ hệ điều hành của bạn (thoát ổ đĩa), nếu không bộ nhớ trong của dụng cụ đo có thể bị hỏng.

Tháo cáp Micro-USB **trong khi** khi vận hành đo và đóng nắp đây (1).

Luôn đóng kín nắp che của giao diện USB, để không có bụi hoặc nước phun xâm nhập vào vỏ bọc.

**Lưu ý:** Chỉ kết nối dụng cụ đo với máy tính qua USB. Dụng cụ đo có thể bị hỏng khi kết nối với các thiết bị khác.

### Truyền dữ liệu qua Bluetooth®

Dụng cụ đo được trang bị mô-đun *Bluetooth*® cho phép truyền dữ liệu không dây từ dụng cụ đo đến thiết bị di động. Các ứng dụng (Apps) đặc biệt của Bosch được cung cấp để sử dụng. Bạn có thể tải nó tùy theo thiết bị đầu cuối trong kho tương ứng.



Các ứng dụng của Bosch cho phép bạn (ngoài việc truyền dữ liệu không dây) một loạt các chức năng và đơn giản hóa việc xử lý sau và chuyển tiếp dữ liệu đo lường (ví dụ: qua email). Bạn có thể tìm thông tin về các yêu cầu hệ thống đối với kết nối *Bluetooth*® trên trang web của Bosch [www.bosch-professional.com/thermal](http://www.bosch-professional.com/thermal).

Để bật kết nối *Bluetooth*® trên dụng cụ đo, hãy mở <Menu chính> lên (xem „Điều hướng trên <Menu chính>“, Trang 86) đặt <Bluetooth> thành <bật>. Trên màn hình xuất hiện đèn chỉ thị (e). Hãy chắc chắn rằng, giao diện *Bluetooth*® trên thiết bị di động đầu cuối của bạn đã được kích hoạt.

Sau khi khởi động ứng dụng Bosch (với các mô-đun *Bluetooth*®-được kích hoạt), kết nối giữa thiết bị di động và dụng cụ đo được thiết lập. Nếu có kết quả cho nhiều lựa chọn, hãy chọn máy đo phù hợp nhất với yêu cầu. Nếu kết quả chỉ cho một lựa chọn, việc thiết lập kết nối sẽ tự động được thực hiện.

**Lưu ý:** Khi thiết lập kết nối (ghép nối) giữa dụng cụ đo và thiết bị di động (ví dụ: điện thoại thông minh, máy tính bảng) lần đầu tiên, có thể yêu cầu mã PIN

cho dụng cụ đo. Trong trường hợp này, hãy nhập “0000”.

Khi truyền dữ liệu bằng *Bluetooth*® điều kiện thu sóng kém có thể gây ra sự trễ thời gian giữa thiết bị di động và dụng cụ đo.

### <Menu chính>

#### Điều hướng trên <Menu chính>



– Để đến <Menu chính> hãy nhấn phím chức năng bên phải (10) dưới biểu tượng menu (I) trên màn hình hiển thị tiêu chuẩn.

– Để điều hướng trong một cấp menu, hãy nhấn phím mũi tên lên (16) hoặc phím mũi tên xuống (13) cho đến khi mục menu mong muốn được tô sáng bằng màu.



– Nếu có một menu phụ cho một mục menu được đánh dấu, thì menu này được biểu thị bằng một mũi tên trỏ sang phải bên cạnh <thiết lập>. Để đi tới menu phụ đó, bạn hãy nhấn phím mũi tên phải (11).



– Nếu có một số tùy chọn cho một mục menu được đánh dấu, cài đặt hiện tại được hiển thị giữa 2 mũi tên. Để thay đổi cài đặt, nhấn phím mũi tên trái (15) hoặc phím mũi tên phải (11). Các giá trị số được thay đổi nhanh hơn nếu bạn giữ phím mũi tên tương ứng.

– Với một số mục menu, bạn có thể bật hoặc tắt một chức năng. Để tắt tính năng này, hãy nhấn vào nút mũi tên trái (15), để <tắt> được đánh dấu. Để bật tính năng này, hãy nhấn vào nút mũi tên phải (11), để <bật> được đánh dấu. Bạn cũng có thể bật và tắt chức năng trong menu bằng cách nhấn nút lưu/gửi (9).



– Để chuyển sang menu trên cùng, hãy nhấn phím chức năng bên trái (17) dưới biểu tượng quay lại. Các cài đặt đã chọn sẽ được lưu.



– Để thoát khỏi <Menu chính> và trở lại trực tiếp màn hình hiển thị tiêu chuẩn, nhấn phím chức năng bên phải (10) dưới biểu tượng ngôi nhà. Các cài đặt đã chọn sẽ được lưu.



– Bạn cũng có thể nhấn nút Đo để thoát khỏi menu bất kỳ và quay lại màn hình hiển thị tiêu chuẩn (4). Khi nhấn nút một lần, các cài đặt đã chọn sẽ được lưu, nhưng chưa có phép đo nào được kích hoạt.

## Menu phụ Phép đo

### <Độ phát xạ> (t)

Đối với một vài nguyên vật liệu thông dụng nhất, có thể lựa chọn độ phát xạ đã lưu. Để giúp tìm kiếm dễ dàng hơn, các giá trị được nhóm lại trong danh mục độ phát xạ. Trong mục menu <Vật liệu>, trước tiên hãy chọn danh mục thích hợp và sau đó chọn nguyên liệu thích hợp. Độ phát xạ phù hợp sẽ được hiển thị trong dòng bên dưới. Nếu bạn biết mức phát xạ chính xác của đối tượng đo của mình, bạn cũng có thể đặt giá trị này làm giá trị số trong mục menu <Độ phát xạ>.

Nếu bạn thường xuyên đo các vật liệu giống nhau, bạn có thể lưu 5 độ phát xạ làm mục yêu thích và gọi chúng ra nhanh chóng bằng cách sử dụng thanh trên cùng (được đánh số từ 1 đến 5).

### <Nhiệt độ phản xạ> (t)

Đặt thông số này có thể cải thiện kết quả đo, đặc biệt đối với các vật liệu có độ phát xạ thấp (= phản xạ cao). Trong một số trường hợp (đặc biệt là trong nhà), nhiệt độ phản xạ tương ứng với nhiệt độ môi trường. Nếu các vật thể có nhiệt độ chênh lệch nhiều gần các vật thể phản xạ cao có thể ảnh hưởng đến phép đo, bạn nên điều chỉnh giá trị này.

## Menu phụ <Thiết bị>

Hãy mở <Menu chính> lên và chọn menu phụ <Thiết bị>. Nó chứa các mục menu sau.

### <Ngôn ngữ>

Trong menu <Ngôn ngữ> bạn có thể thay đổi ngôn ngữ hiển thị.

### <Thời gian & Ngày tháng>

Để thay đổi ngày và giờ trên màn hình (a), hãy vào menu phụ <Thời gian & Ngày tháng>. Trong menu phụ này, bạn cũng có thể thay đổi định dạng ngày và giờ.

Để thoát menu phụ <Thời gian & Ngày tháng> hãy nhấn phím chức năng bên trái (17), để lưu cài đặt hoặc phím chức năng bên phải (10), để hủy các thay đổi.

### <Đơn vị>

Trong menu <Đơn vị> bạn có thể chọn xem thông tin nhiệt độ bằng <°C> hoặc <°F>.

### <Laser>

Trong menu <Laser> bạn có thể bật và tắt laser của thiết bị đo. Laser dùng để giới hạn vùng đo và do đó chỉ nên vô hiệu hóa trong những trường hợp ngoại lệ.

### <Khung đo lường>

Trong menu <Khung đo lường> bạn có thể bật hoặc tắt khung đo (b) trên màn hình.

### <Sơ đồ màu>

Trong menu <Sơ đồ màu> bạn có thể chọn màu mà các giá trị nhiệt độ và các chỉ báo khác xuất hiện trên màn hình. Cài đặt này cũng được áp dụng cho các ảnh chụp màn hình đã lưu.

### <Thời gian tắt>

Trong menu <Thời gian tắt>, bạn có thể chọn khoảng thời gian mà sau đó dụng cụ đo sẽ tự động tắt nếu không có phím nào được nhấn. Bạn cũng có thể tắt tính năng tự động tắt bằng cách chọn cài đặt <Không bao giờ>. Thời gian tắt máy được đặt càng ngắn thì càng tiết kiệm được nhiều năng lượng.

### <T.gian h.thị đèn>

Trong menu <T.gian h.thị đèn>, bạn có thể chọn khoảng thời gian mà sau đó giảm độ sáng của đèn màn hình nếu không có phím nào được nhấn trên dụng cụ đo. Bạn cũng có thể chiếu sáng màn hình thường trực bằng cách chọn cài đặt <Luôn luôn>. Thời lượng sáng được đặt càng ngắn thì càng tiết kiệm được nhiều năng lượng.

### <Tin hiệu âm>

Trong menu <Tin hiệu âm>, bạn có thể chuyển đổi tín hiệu âm thanh phát ra khi bật hoặc tắt cảnh báo nhiệt độ bề mặt.

### <Xóa tất cả hình ảnh>

Trong menu <Xóa tất cả hình ảnh>, bạn có thể xóa tất cả tệp trong bộ nhớ trong cùng một lúc. Nhấn phím mũi tên phải (11) cho <Thêm>, để vào menu phụ. Sau đó nhấn phím chức năng bên phải (10), để xóa tất cả các tệp hoặc phím chức năng bên trái (17), để hủy.



### <Thông tin thiết bị>



Để biết thông tin về dụng cụ đo, hãy vào menu phụ <Thông tin thiết bị>. Ở đó, bạn sẽ tìm thấy số seri của máy đo và phiên bản phần mềm được cài đặt.

### <K.phục c.đặt gốc>

Trong mục menu này, bạn có thể đặt lại dụng cụ đo về cài đặt gốc và xóa vĩnh viễn tất cả dữ liệu. Quá trình này có thể mất vài phút. Nhấn phím mũi tên phải (11) cho <Thêm>, để vào menu phụ. Sau đó nhấn phím chức năng bên phải (10), để xóa tất cả các tệp hoặc phím chức năng bên trái (17), để hủy.

## Lỗi – Nguyên nhân và biện pháp khắc phục

Lỗi	Nguyên nhân	Biện pháp khắc phục
	Không thể bật dụng cụ đo. Hết pin	Sạc pin hoặc thay pin.
	Pin quá nóng hoặc quá lạnh	Để pin nguội hoặc thay pin.
	Bộ nhớ hình ảnh bị lỗi	Định dạng bộ nhớ trong bằng cách xóa tất cả ảnh (xem „<Xóa tất cả hình ảnh>“, Trang 87). Nếu sự cố vẫn tiếp diễn, hãy

Lỗi	Nguyên nhân	Biện pháp khắc phục
	Bộ nhớ hình ảnh đầy	gửi dụng cụ đo đến trung tâm dịch vụ khách hàng được ủy quyền của Bosch. Nếu cần, hãy chuyển hình ảnh sang phương tiện lưu trữ khác (ví dụ: máy tính hoặc máy tính xách tay). Sau đó xóa ảnh trong bộ nhớ trong.
	Dụng cụ đo bị lỗi	Hãy gửi dụng cụ đo đến trung tâm dịch vụ khách hàng được ủy quyền của Bosch.
Hiển thị chức năng (s) để đo nhiệt độ tiếp xúc không xuất hiện trên màn hình.	Cổng kết nối (25) cho cáp nhiệt điện hoặc cáp nhiệt điện bị lỗi	Hãy kiểm tra chức năng của cáp nhiệt điện và gửi dụng cụ đo đến trung tâm dịch vụ khách hàng được ủy quyền của Bosch.
Không thể kết nối dụng cụ đo với máy tính.	Máy tính không nhận biết được dụng cụ đo.	Đảm bảo rằng trình điều khiển trên máy tính của bạn được cập nhật. Có thể cần phiên bản hệ điều hành mới hơn trên máy tính.
	Cổng kết nối micro-USB-hoặc cáp micro-USB hỏng	Kiểm tra xem dụng cụ đo có thể được kết nối với máy tính khác không. Nếu không, hãy gửi dụng cụ đo đến trung tâm dịch vụ khách hàng được ủy quyền của Bosch.
	Cảm biến độ ẩm và nhiệt độ môi trường xung quanh (5) bị lỗi	Các chức năng khác của dụng cụ đo vẫn có thể được sử dụng. Hãy gửi dụng cụ đo đến trung tâm dịch vụ khách hàng được ủy quyền của Bosch.

## Giải thích khái niệm

### Bức xạ nhiệt hồng ngoại

Bức xạ nhiệt hồng ngoại là bức xạ điện từ do mọi cơ thể phát ra trên 0 Kelvin (-273 °C). Lượng bức xạ phụ thuộc vào nhiệt độ và độ phát xạ của cơ thể.

### Độ phát xạ

Độ phát xạ của một vật phụ thuộc vào nguyên vật liệu và cấu trúc bề mặt của vật đó. Nó cho biết vật thể phát ra bao nhiêu bức xạ nhiệt hồng ngoại so với một bộ tản nhiệt lý tưởng (vật đen, độ phát xạ  $\epsilon = 1$ ) và theo đó là giá trị từ 0 đến 1.

### Nhiệt độ được phản xạ/tính phản xạ của đối tượng

Nhiệt độ được phản xạ là những bức xạ nhiệt, không tự phát ra từ đối tượng. Tùy thuộc vào cấu trúc và vật liệu, bức xạ xung quanh được phản xạ qua nhiệt độ thực tế.

### Cấu nhiệt

Cấu nhiệt là một điểm trên tường ngoài của một tòa nhà nơi kết cấu gây ra sự mất nhiệt tăng cục bộ. Để có thể đánh giá cấu nhiệt, có thể sử dụng các yêu cầu tối thiểu về cách nhiệt được mô tả trong DIN 4108-2.

Theo DIN 4108-2, yêu cầu tối thiểu về bảo vệ nhiệt được đáp ứng nếu hệ số nhiệt độ  $f_{Rsi}$  lớn hơn 0,7.

Hệ số nhiệt độ  $f_{Rsi}$  được tính như sau:

$$f_{Rsi} = \frac{T_1 - T_2}{T_3 - T_2}$$

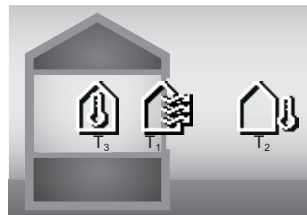

$T_1$ : Nhiệt độ bề mặt bên trong

$T_2$ : Nhiệt độ bên ngoài

$T_3$ : Nhiệt độ môi trường bên trong

Cách nhiệt tối thiểu giúp tránh nấm mốc trong các điều kiện biên tiêu chuẩn. Điều này tránh gây nguy hiểm cho kết cấu xây dựng.

Trong điều kiện tiêu chuẩn (nhiệt độ bên ngoài -5 °C, nhiệt độ môi trường bên trong 20 °C), nhiệt độ bề mặt không được giảm xuống dưới 12,6 °C. Điều này tương ứng với giá trị giới hạn  $f_{Rsi}$  là 0,7. Để có kết quả có ý nghĩa nhất có thể (độ không đảm bảo đo nhỏ), nhiệt độ bên ngoài phải dưới 10 °C.

### Độ ẩm tương đối

Độ ẩm tương đối cho biết không khí bão hòa hơi nước mạnh như thế nào. Thông tin được đưa ra dưới dạng phần trăm lượng hơi nước tối đa mà không khí có thể hấp thụ. Lượng hơi nước tối đa phụ thuộc vào nhiệt độ: nhiệt độ càng cao thì không khí càng hấp thụ được nhiều hơi nước. Nếu độ ẩm tương đối quá cao, nguy cơ nấm mốc sẽ tăng lên. Độ ẩm quá thấp có thể dẫn đến các vấn đề sức khỏe.



### Nhiệt độ điểm sương

Nhiệt độ điểm sương cho biết nhiệt độ mà hơi nước chứa trong không khí bắt đầu ngưng tụ. Nhiệt độ điểm sương phụ thuộc vào độ ẩm tương đối và nhiệt độ không khí.

Nếu nhiệt độ của bề mặt thấp hơn nhiệt độ điểm sương, thì nước bắt đầu ngưng tụ trên bề mặt này. Sự ngưng tụ trên bề mặt là nguyên nhân chính gây ra sự phát triển của nấm mốc.

## Bảo Dưỡng và Bảo Quản

### Bảo Dưỡng Và Làm Sạch

Luôn luôn giữ cho dụng cụ đo thật sạch sẽ. Ống kính thu tia hồng ngoại bán (23) có thể làm giảm độ chính xác của phép đo.

Lau sạch các mảnh vụn hay chất bẩn bằng vải khô và mềm. Không được sử dụng chất tẩy rửa.

Tuyệt đối không để nước rò vào máy trong quá trình làm sạch.

Đặc biệt, vệ sinh cảm biến độ ẩm và nhiệt độ (5), camera (22), ống kính thu (23), đèn (24) cửa chiếu laser (2) thật cẩn thận: Đảm bảo không để lông tơ dính lên camera, ống kính thu hoặc cửa chiếu laser. Chỉ vệ sinh camera, ống kính thu và cửa chiếu laser bằng các chất thích hợp cho ống kính máy ảnh. Không thử dùng vật nhọn để lấy chất bẩn khỏi các cảm biến, camera hoặc ống kính thu, và không lau qua camera và ống kính thu (rủi ro gây xước).

Không bảo quản dụng cụ đo bên ngoài phạm vi độ ẩm từ 30 đến 50 % trong thời gian dài. Nếu dụng cụ đo được bảo quản quá ẩm hoặc quá khô, các phép đo không chính xác có thể xảy ra trong quá trình chạy thử.

Cảm biến độ ẩm không khí vốn nhạy cảm với dung môi, chất kết dính và chất làm mềm. Ảnh hưởng lâu dài của các chất này có thể dẫn đến sai lệch về độ ẩm không khí đo được.

Không bảo quản thiết bị đo trong túi nhựa, mà hơi của nó có thể làm hỏng cảm biến nhiệt độ và độ ẩm (5). Không dán băng keo gắn cảm biến trên máy đo.

Nếu bạn muốn hiệu chuẩn lại dụng cụ đo của mình, vui lòng liên hệ với trung tâm dịch vụ khách hàng được ủy quyền của Bosch.

Chỉ được cất giữ và vận chuyển dụng cụ đo trong túi xách bảo vệ được giao kèm.

Trong trường hợp cần sửa chữa, hãy gửi dụng cụ đo trong túi bảo vệ.

### Dịch vụ hỗ trợ khách hàng và tư vấn sử dụng

Bộ phận phục vụ hàng sau khi bán của chúng tôi trả lời các câu hỏi liên quan đến việc bảo dưỡng và sửa chữa các sản phẩm cũng như phụ tùng thay

thế của bạn. Sơ đồ mô tả và thông tin về phụ tùng thay thế cũng có thể tra cứu theo dưới đây:

**www.bosch-pt.com**

Đội ngũ tư vấn sử dụng của Bosch sẽ giúp bạn giải đáp các thắc mắc về sản phẩm và phụ kiện.

Trong tất cả các phản hồi và đơn đặt phụ tùng, xin vui lòng luôn luôn nhập số hàng hóa 10 chữ số theo nhãn của hàng hóa.

### Việt Nam

CN CÔNG TY TNHH BOSCH VIỆT NAM TẠI TP.HCM

Tầng 14, Ngôi Nhà Đức, 33 Lê Duẩn

Phường Bến Nghé, Quận 1, Thành Phố Hồ Chí Minh

Tel.: (028) 6258 3690

Fax: (028) 6258 3692 - 6258 3694

Hotline: (028) 6250 8555

Email: [tuvankhachhang-pt@vn.bosch.com](mailto:tuvankhachhang-pt@vn.bosch.com)

[www.bosch-pt.com.vn](http://www.bosch-pt.com.vn)

[www.baohanhbosch-pt.com.vn](http://www.baohanhbosch-pt.com.vn)

### Xem thêm địa chỉ dịch vụ tại:

[www.bosch-pt.com/serviceaddresses](http://www.bosch-pt.com/serviceaddresses)

### Vận chuyển

Pin có chứa Li-Ion là đối tượng phải tuân theo các qui định của Pháp Luật về Hàng Hóa Nguy Hiểm. Người sử dụng có thể vận chuyển pin hợp khối bằng đường bộ mà không cần thêm yêu cầu nào khác.

Khi được vận chuyển thông qua bên thứ ba (vd. vận chuyển bằng đường hàng không hay đại lý giao nhận), phải tuân theo các yêu cầu đặc biệt về đóng gói và dán nhãn. Phải tham vấn chuyên gia về hàng hóa nguy hiểm khi chuẩn bị gói hàng.

Chỉ gửi pin hợp khối khi vỏ ngoài không bị hư hỏng. Dán băng keo hay che kín các điểm tiếp xúc hở và đóng gói pin hợp khối theo cách sao cho pin không thể xô dịch khi nằm trong bao bì. Ngoài ra, xin vui lòng chấp hành các qui định chi tiết có thể được bổ sung thêm của quốc gia.

### Sự thải bỏ



Máy đo, ắc quy/pin, phụ kiện và bao bì cần được tái sử dụng theo quy định về môi trường.



Không vứt dụng cụ đo và pin/ắc quy cùng trong rác thải của gia đình!

### Chỉ dành cho các quốc gia thuộc khối Liên minh Châu Âu (EU):

Dụng cụ đo không còn giá trị sử dụng theo chỉ thị châu Âu 2012/19/EU và ắc quy/pin bị hỏng hoặc đã qua sử dụng theo chỉ thị số 2006/66/EC phải được thu gom riêng và có thể tái sử dụng theo luật môi trường.

**Pin:**

**Li-ion:**

Tuân thủ những hướng dẫn trong phần vận chuyển  
(xem „Vận chuyển“, Trang 89).

<b>de</b>	Hiermit erklärt <b>Robert Bosch Power Tools GmbH</b> , dass der Funkanlagentyp <b>GIS 1000 C</b> der Richtlinie 2014/53/EU entspricht. Der vollständige Text der EU-Konformitätserklärung ist unter der folgenden Internetadresse verfügbar:
<b>en</b>	Hereby, <b>Robert Bosch Power Tools GmbH</b> declares that the radio equipment type <b>GIS 1000 C</b> is in compliance with Directive 2014/53/EU. The full text of the EU declaration of conformity is available at the following internet address:
<b>fr</b>	Le soussigné, <b>Robert Bosch Power Tools GmbH</b> , déclare que l'équipement radioélectrique du type <b>GIS 1000 C</b> est conforme à la directive 2014/53/UE. Le texte complet de la déclaration UE de conformité est disponible à l'adresse internet suivante :
<b>es</b>	Por la presente, <b>Robert Bosch Power Tools GmbH</b> declara que el tipo de equipo radioeléctrico <b>GIS 1000 C</b> es conforme con la Directiva 2014/53/UE. El texto completo de la declaración UE de conformidad está disponible en la dirección Internet siguiente:
<b>pt</b>	A abaixo assinada <b>Robert Bosch Power Tools GmbH</b> declara que o presente tipo de equipamento de rádio <b>GIS 1000 C</b> está em conformidade com a Diretiva 2014/53/UE. O texto integral da declaração de conformidade está disponível no seguinte endereço de Internet:
<b>it</b>	Il fabbricante, <b>Robert Bosch Power Tools GmbH</b> , dichiara che il tipo di apparecchiatura radio <b>GIS 1000 C</b> è conforme alla direttiva 2014/53/UE. Il testo completo della dichiarazione di conformità UE è disponibile al seguente indirizzo Internet:
<b>nl</b>	Hierbij verklaar ik, <b>Robert Bosch Power Tools GmbH</b> , dat het type radioapparatuur <b>GIS 1000 C</b> conform is met Richtlijn 2014/53/EU. De volledige tekst van de EU-conformiteitsverklaring kan worden geraadpleegd op het volgende internet-adres:
<b>da</b>	Hermed erklærer <b>Robert Bosch Power Tools GmbH</b> , at radioudstyrstypen <b>GIS 1000 C</b> er i overensstemmelse med direktiv 2014/53/EU. EU-overensstemmelseserklæringens fulde tekst kan findes på følgende internetadresse:
<b>sv</b>	Härmed försäkrar <b>Robert Bosch Power Tools GmbH</b> att denna typ av radioutrustning <b>GIS 1000 C</b> överensstämmer med direktiv 2014/53/EU. Den fullständiga texten till EU-försäkran om överensstämmelse finns på följande webbadress:
<b>no</b>	<b>Robert Bosch Power Tools GmbH</b> erklærer herved at radioutstyrstypen <b>GIS 1000 C</b> er i overensstemmelse med direktivet 2014/53/EU. Den fullstendige teksten i EU-samsvarserklæringen er tilgjengelig på følgende nettadresse:
<b>fi</b>	<b>Robert Bosch Power Tools GmbH</b> vakuuttaa, että radiolaitetyypin <b>GIS 1000 C</b> on direktiivin 2014/53/EU mukainen. EU-vaatimustenmukaisuusvakuutuksen täysimittainen teksti on saatavilla seuraavassa internetosoitteessa:
<b>el</b>	Με την παρούσα ο/η <b>Robert Bosch Power Tools GmbH</b> , δηλώνει ότι ο ραδιοεξοπλισμός <b>GIS 1000 C</b> πληροί την οδηγία 2014/53/ΕΕ. Το πλήρες κείμενο της δήλωσης συμμόρφωσης ΕΕ διατίθεται στην ακόλουθη ιστοσελίδα στο διαδίκτυο:
<b>tr</b>	<b>Robert Bosch Power Tools GmbH</b> , <b>GIS 1000 C</b> radyo ekipmanı tipinin Direktif 2014/53/EU ile uyumlu olduğunu beyan eder. AB uygunluk beyanının tam metnine aşağıdaki internet adresinden ulaşabilirsiniz:
<b>pl</b>	<b>Robert Bosch Power Tools GmbH</b> niniejszym oświadcza, że typ urządzenia radiowego <b>GIS 1000 C</b> jest zgodny z dyrektywą 2014/53/UE. Pełny tekst deklaracji zgodności UE jest dostępny pod następującym adresem internetowym:
<b>cs</b>	Tímto <b>Robert Bosch Power Tools GmbH</b> prohlašuje, že typ rádiového zařízení <b>GIS 1000 C</b> je v souladu se směrnicí 2014/53/EU. Úplné znění EU prohlášení o shodě je k dispozici na této internetové adrese:
<b>sk</b>	<b>Robert Bosch Power Tools GmbH</b> týmto vyhlasuje, že rádiové zariadenie typu <b>GIS 1000 C</b> je v súlade so smernicou 2014/53/EÚ. Úplné EÚ vyhlásenie o zhode je k dispozícii na tejto internetovej adrese:
<b>hu</b>	<b>Robert Bosch Power Tools GmbH</b> igazolja, hogy a <b>GIS 1000 C</b> típusú rádióberendezés megfelel a 2014/53/EU irányelvnek. Az EU-megfelelési nyilatkozat teljes szövege elérhető a következő internetes címen:
<b>ru</b>	Сим <b>Robert Bosch Power Tools GmbH</b> заявляет, что радиооборудование типа <b>GIS 1000 C</b> соответствует Директиве 2014/53/EU. С полным текстом декларации о соответствии EU можно ознакомиться по следующему Интернет-адресу:
<b>uk</b>	Цим <b>Robert Bosch Power Tools GmbH</b> заявляє, що радіобладнання типу <b>GIS 1000 C</b> відповідає Директиві 2014/53/EU. З повним текстом декларації відповідності EU можна ознайомитися за такою Інтернет-адресою:
<b>kk</b>	Осымен <b>Robert Bosch Power Tools GmbH</b> компаниясы <b>GIS 1000 C</b> түріндегі радио жабдықтарды 2014/53/EU директивасына сайлығын мағлұмдайды. ЕО сәйкестік мағлұмдамасы төмендегі интернет мекенжайында қолжетімді:
<b>ro</b>	Prin prezenta, <b>Robert Bosch Power Tools GmbH</b> declară că tipul de echipamente radio <b>GIS 1000 C</b> este în conformitate cu Directiva 2014/53/UE. Textul integral al declarației UE de conformitate este disponibil la următoarea adresă internet:

- bg** С настоящото **Robert Bosch Power Tools GmbH** декларира, че този тип радиосъоръжение **GIS 1000 C** е в съответствие с Директива 2014/53/ЕС. Цялостният текст на ЕС декларацията за съответствие може да се намери на следния интернет адрес:
- mk** Со ова, **Robert Bosch Power Tools GmbH** потврдува дека типот на радио опрема **GIS 1000 C** е во согласност со Директивата 2014/53/EU. Целосниот текст на Изјавата за сообразност на ЕУ може да го прочитате на следнава интернет страница:
- sr** Ovim **Robert Bosch Power Tools GmbH** izjavljuje da je radio-oprema tipa **GIS 1000 C** u skladu sa direktivom 2014/53/EU. Kompletan tekst EC izjave o usaglašenosti je dostupan na sledećoj veb-adresi:
- sl** **Robert Bosch Power Tools GmbH** potrjuje, da je tip radijske opreme **GIS 1000 C** skladen z Direktivo 2014/53/EU. Celotno besedilo izjave EU o skladnosti je na voljo na naslednjem spletnem naslovu:
- hr** **Robert Bosch Power Tools GmbH** ovime izjavljuje da je radijska oprema tipa **GIS 1000 C** u skladu s Direktivom 2014/53/EU. Cjeloviti tekst EU izjave o sukladnosti dostupan je na sljedećoj internetskoj adresi:
- et** Käesolevaga deklareerib **Robert Bosch Power Tools GmbH**, et käesolev raadioseadme tüüp **GIS 1000 C** vastab direktiivi 2014/53/EL nõuetele. ELi vastavusdeklaratsiooni täielik tekst on kättesaadav järgmisel internetiaadressil:
- lv** Ar šo **Robert Bosch Power Tools GmbH** deklarē, ka radioiekārta **GIS 1000 C** atbilst Direktīvai 2014/53/ES. Pilns ES atbilstības deklarācijas teksts ir pieejams šādā interneta vietnē:
- lt** Aš, **Robert Bosch Power Tools GmbH**, patvirtinu, kad radijo įrenginių tipas **GIS 1000 C** atitinka Direktyvą 2014/53/ES. Visas ES atitikties deklaracijos tekstas prieinamas šiuo interneto adresu:

-> <http://eu-doc.bosch.com/>